

LMC

BEDIENUNGSANLEITUNG **INNOVAN**

OPERATING MANUAL

GEBRUIKERSHANDLEIDING

MANUEL D'UTILISATION

MANUAL DE INSTRUCCIONES

ISTRUZIONI D'USO

BRUGSANVISNING

KÄYTTÖOHJEET

KULLANIM KILAVUZU

操作说明

Please also observe the chassis manufacturer's operating instructions at all times.

The terms used in these operating instructions with regard to weight specifications are explained again in detail at the end of the operating instructions (legal information on weight-related specifications). For further details on weight specifications, please also refer to the "Weight information" section of our homepage at www.lmc-caravan.com/de/en/weight-information

1	Warranty	5	5.8	Headrests	39
2	Introduction	7	5.9	Seating arrangement	39
2.1	General	8	5.10	Filling up with diesel	39
2.2	Technical data	8	6	Setting up the Camper Van	41
2.3	Environmental tips	9	6.1	Handbrake	41
3	Safety	11	6.2	Entrance step	41
3.1	Fire prevention	11	6.3	Ramps	41
3.1.1	Avoidance of fire risks	11	6.4	230 V connection	41
3.1.2	Fire-fighting	11	6.5	Refrigerator	41
3.1.3	In case of fire	11	7	Living	43
3.2	General	12	7.1	Doors	43
3.3	Road safety	12	7.1.1	Insect screen on the sliding door, extendable	43
3.4	Towing	14	7.1.2	Rear doors	44
3.5	Gas system	14	7.2	External flaps	44
3.5.1	General instructions	14	7.3	Ventilation	45
3.5.2	Gas bottle	15	7.4	Windows	45
3.6	Electrical system	16	7.4.1	Hinged window	46
3.7	Water system	16	7.4.2	Roman shade and insect screen	47
4	Before the journey	17	7.4.3	Cabin black-out shade	48
4.1	Initial start-up	17	7.5	Skylights	48
4.2	Vehicle load capacity	17	7.5.1	Skylight with snap latch	49
4.2.1	Terms	18	7.5.2	Heki skylight	50
4.2.2	Calculating the vehicle load capacity	21	7.6	Tables	51
4.2.3	Load securing and load distribution	22	7.6.1	Suspension table with separable support leg	51
4.2.4	Rear storage space	26	7.7	PVC-floor covering	52
4.3	Towing	27	7.8	Lamps	52
4.4	Entrance step	28	7.8.1	Lighting system and USB socket	52
4.5	Removable partition wall	29	7.8.2	Lamp in the rear area	54
4.6	Flat screen	30	7.9	TV unit	54
4.7	Gas regulator	30	7.10	Beds	55
4.8	Snow chains	31	7.10.1	Transverse rear bed	55
4.9	Road safety	31	7.10.2	Longitudinal rear beds	55
5	During the journey	35	7.10.3	Bunk bed in the rear	58
5.1	Driving the Camper Van	35	7.11	Converting seating group for sleeping	59
5.2	Driving speed	35	7.12	Elevating roof	59
5.3	Brakes	36	8	Gas system	65
5.4	Seat belts	36	8.1	General instructions	65
5.4.1	General	36	8.2	Gas bottles	66
5.4.2	Fastening the seat belts correctly	37	8.3	Gas pressure regulating system DuoControl CS	67
5.5	Child restraint systems	37	8.4	Changing gas bottles	71
5.6	ISOFIX child safety seat mounting system	38	8.5	Gas isolator taps	72
5.7	Driver's seat and front passenger's seat	39			

Contents

9	Electrical system..... 73		
9.1	General safety instructions..... 73	11.2.5	Draining water 109
9.2	Terms..... 73	11.2.6	Emptying the water system 109
9.3	12 V power supply 74	11.3	Waste water tank..... 110
9.3.1	Living area battery Type AGM..... 75	11.4	Insulated and heated waste water tank..... 111
9.3.2	Charging batteries via a 230 V power supply 76	11.5	Toilet compartment..... 112
9.3.3	Charging batteries via the vehicle engine (alternator) 76	11.6	Toilet..... 113
9.3.4	Charging the starter battery..... 76	11.6.1	Swivel toilet..... 113
9.3.5	Charging booster for the living area battery..... 78	11.6.2	Emptying the sewage tank 114
9.4	Transformer/rectifier (EBL 31)..... 79	11.6.3	Winter operation 115
9.4.1	Battery cut-off switch 80	11.6.4	Temporary lay-up 115
9.4.2	Battery selector switch..... 80		
9.4.3	Battery monitor 81	12	Care..... 117
9.4.4	Charging the battery 81	12.1	External care 117
9.4.5	Assignment of the "SAT preparation" cable 81	12.1.1	General..... 117
9.5	Panel (LT 100)..... 82	12.1.2	Washing with a high-pressure cleaner 117
9.5.1	12 V main switch 82	12.1.3	Washing the vehicle 118
9.5.2	LED array for battery voltage 83	12.1.4	Windows of acrylic glass 118
9.5.3	LED array for tank fill level 84	12.1.5	Underbody 119
9.6	230 V power supply 85	12.1.6	Cleaning the entrance step 119
9.6.1	230 V connection (CEE socket outlet)..... 85	12.1.7	Cleaning the elevating roof..... 120
9.6.2	Connecting the 230 V power supply..... 85	12.2	Interior care 120
9.7	Fuses..... 87	12.2.1	Refrigerator..... 121
9.7.1	12 V fuses..... 87	12.3	Stainless steel surfaces..... 122
9.7.2	230 V fuse 89	12.4	Water system 123
		12.4.1	Cleaning the water tank..... 123
10	Appliances..... 91	12.4.2	Cleaning the water pipes..... 123
10.1	General..... 91	12.4.3	Disinfecting the water system..... 124
10.2	Heater / production of hot water 91	12.4.4	Cleaning the waste water tank 124
10.2.1	To heat properly 92	12.5	Care for vehicle operation in winter.... 124
10.2.2	Heater and production of hot water (Truma Combi) 93	12.5.1	Preparations 125
10.2.3	Diesel heater and production of hot water (Truma Combi D)..... 95	12.5.2	Winter operation 125
10.2.4	Independent vehicle heater (Webasto) 96	12.5.3	At the end of the winter season..... 125
10.2.5	Boiler (Whale)..... 97	12.6	Lay-up..... 125
10.2.6	Wall flue..... 98	12.6.1	Temporary lay-up 125
10.3	Gas cooker 99	12.6.2	Winter lay-up 127
10.4	Refrigerator..... 101	12.6.3	Starting up the vehicle after a temporary lay-up or after lay-up over winter 128
10.4.1	Compressor refrigerator 101		
10.4.2	Refrigerator door locking mechanism 103	13	Maintenance 129
		13.1	Official inspections 129
11	Sanitary fittings..... 105	13.2	Inspection work 130
11.1	Water supply, general..... 105	13.3	Maintenance and servicing work..... 130
11.2	Water tank 106	13.3.1	Base vehicle 131
11.2.1	Drinking water filler neck with cap 106	13.3.2	Fixed time interval 131
11.2.2	Filling the water system..... 107	13.4	Elevating roof 131
11.2.3	Topping up the water..... 108	13.5	Gas fired boiler (Whale) 132
11.2.4	Reducing the water quantity for mobile operation 108	13.6	Replacing illuminants, external..... 132
		13.7	Replacing illuminants, internal..... 133
		13.8	Spare parts 134
		13.9	Vehicle identification plate..... 134
		13.10	Warning and information stickers 135
		13.11	Dealers 135

14	Wheels and tyres 137	16	Dimensions and permissible number of persons 153
14.1	General 137		
14.2	Tyre selection 138		
14.3	Tyre specifications 139		
14.4	Handling of tyres 139		
14.5	Tightening torque 139		
14.6	Tyre pressure 140		
15	Troubleshooting 143	17	Helpful notes 155
15.1	Braking system 143	17.1	Traffic rules in foreign countries 155
15.2	Electrical system 143	17.2	Help on Europe's roads 155
15.3	Gas system 146	17.3	Gas supply in European countries 156
15.4	Cooker 147	17.4	Toll regulations in European countries 156
15.5	Heater/boiler 147	17.5	Tips on staying overnight safely during travel 157
15.5.1	Independent vehicle heater (Webasto) 148	17.6	Tips for winter campers 157
15.6	Refrigerator 149	17.7	Travel checklists 158
15.6.1	General 149	18	Legal notes on weight-related information 161
15.7	Water supply 150		
15.8	Body 151		

Contents

Warranty certificate

Vehicle data
Model:
Car manufacturer/type of engine:
Serial number:
Delivery date:
Initial registration:
Purchased from company:
Expiry of the warranty period:
Key number:
Chassis number:
Customer address:
Surname, Christian name:
Street, house number:
Postal code, town:
Dealer's stamp and signature

We reserve the right to alter the construction, equipment and the scope of delivery. Optional equipment is also listed that is not included in the standard scope of delivery. The descriptions and illustrations in this brochure do not relate to a particular version. For all details, only the respective equipment list is valid.

Disclaimer

All technical information, data and instructions for use, operation and maintenance given in these instruction manual are correct at the time of going to press.

No legal claims can be derived from the information, illustrations and descriptions used in this instruction manual.

We accept no liability for damage due to:

- Disregard of this instruction manual
- Use other than for the intended purpose
- Improper repairs
- Technical modifications to the existing system
- Installation of non-approved spare parts

Please read this instruction manual completely before using the vehicle for the first time!

Always keep this instruction manual in the vehicle. Also inform all other users of the safety regulations.



- ▶ The non-observance of this symbol can lead to personal injury.



- ▷ The non-observance of this symbol can lead to damage being caused to, or inside the vehicle.



- ▷ This symbol indicates recommendations or special aspects.



- ▷ This symbol indicates actions which lead to environmental awareness.

With your motorhome you will receive a file with the following vehicle manuals and documents:

- Operating and installation instructions of various appliances
- Complete set of documents from the chassis manufacturer
- Test certificate for the gas system in accordance with German regulations

This instruction manual contains sections which describe model-specific equipment or optional equipment. These sections are not specially marked. It may be that your vehicle has not been fitted with this optional equipment. In some cases, the actual equipment of your vehicle may therefore be different from that shown in some illustrations and descriptions.

However, your vehicle may be fitted with other optional equipment not described in this instruction manual.

Optional equipment is described when an explanation is required.

Adhere to the instruction manuals which are separately enclosed.



- ▷ The details "right", "left", "front" and "rear" always refer to the vehicle in direction of travel.
- ▷ All dimensions and weight details are "approximate".

Should the vehicle be subjected to damage due to a failure to follow the instructions in this instruction manual, then the warranty claim is deemed invalid.

Our vehicles are subjected to continuous development. Please understand that we reserve the right to alter the form, equipment and technology. Therefore, no claims can be made against the manufacturer as a result of the contents of this instruction manual. The equipment which was known and included at the time of going to press is described.

The reprinting, translation and copying, including extracts is not permitted without prior written authorisation from the manufacturer.

2.1 General

The vehicle is constructed in accordance with the latest technology and the recognised safety regulations. Nevertheless, personal injury may result and the vehicle may be damaged if the safety instructions in this instruction manual are not followed.

Before using the vehicle for the first time, equip it with the legally prescribed equipment (e.g. first aid kit, warning vest, hazard warning triangle etc.). Observe the relevant equipment regulations when travelling abroad.

Only use the vehicle in a technically impeccable condition. Follow the instructions in the instruction manual.

Malfunctions which impair the safety of persons or the vehicle should be immediately remedied by qualified personnel. To avoid further damages, observe the duty to avert, minimise or mitigate loss for the user during faults.

Have the vehicle's braking and gas systems inspected and repaired by an authorised specialist workshop only.

Alterations to the body are only to be carried out with the authorisation of the manufacturer.

The vehicle is designed for the exclusive transport of persons. Luggage and accessories may only be transported up to the maximum permissible gross weight.

Observe the test and inspection periods stipulated by the manufacturer.

2.2 Technical data



- ▷ Only the details provided in the actual vehicle documentation shall be binding with regard to the technical data.
- ▷ The measurements as well as the net weight of the vehicle may change when mounting accessories or optional equipment. This may result in a reduction of the permissible number of persons. Differences due to manufacturing tolerances (+/- 5 %) are possible and permissible.

Further information can be found in the operating manual of the base vehicle. The technical data are not a component of the instruction manual.

The technical data can be obtained from the manufacturer's documentation. Alternatively, the authorised dealer or service centre will also be happy to advise you.

2.3 Environmental tips



- ▷ Be considerate of the environment.
- ▷ Remember that: All kinds of waste water and household waste are not to be disposed of in drains or in the open countryside.
- ▷ On board, collect waste water only in the waste water tank or – if necessary – in other containers designed for that purpose.
- ▷ Only empty the waste water tank and toilet cassette or sewage tank at disposal stations at the camping or caravan sites, which are especially provided for this purpose. When stopping in towns and communities, observe the instructions at caravan sites or ask where there are disposal stations.
- ▷ Empty waste water tank as often as possible, even when it is not completely full (hygiene).
- ▷ If possible, flush out waste water tank and, if necessary, drainage pipe with fresh water every time it is emptied.
- ▷ Never allow the toilet cassette or sewage tank to become too full. Empty the toilet cassette or sewage tank frequently, at the latest as soon as the level indicator lights up.
- ▷ Separate household waste according to glass, tin cans, plastic and wet waste also when on a journey. Enquire at the town or community authority about disposal points. Household waste is not to be disposed of in waste paper baskets which are situated at car parks.
- ▷ When parked, do not allow the engine to run more than necessary. When running idle, a cold engine releases more contaminants than usual. The running temperature of the engine is achieved more quickly whilst the vehicle is in motion.
- ▷ Use an environmentally-friendly WC chemical agent for the WC which can also be biologically degraded and only use small doses.
- ▷ When staying in towns and communities for long periods, search for parking areas which are specially reserved for motorhomes. Enquire at the town or community authority about parking spaces.
- ▷ Always leave the parking places in a clean condition.

Chapter overview

This chapter contains important safety instructions. The safety instructions are for the protection of persons and property.

3.1 Fire prevention

3.1.1 Avoidance of fire risks



- ▶ Never leave children in the vehicle unattended.
- ▶ Keep flammable materials clear of heating and cooking appliances.
- ▶ Never use portable heating or cooking appliances.
- ▶ Only authorised qualified personnel may make changes to the electrical system, gas system or appliances.

3.1.2 Fire-fighting



- ▶ Always carry a dry powder fire extinguisher in the vehicle. The fire extinguisher must be approved, tested and close at hand.
- ▶ The fire extinguisher is not included in the scope of delivery.
- ▶ Have the fire extinguisher tested at regular intervals by authorised qualified personnel. Observe the date of testing.
- ▶ Keep a fire blanket near the cooker.

3.1.3 In case of fire



- ▶ Evacuate all passengers.
- ▶ Cut off the electrical power supply and disconnect from the mains.
- ▶ Close regulator tap on the gas bottle.
- ▶ Sound the alarm and call the fire brigade.
- ▶ Fight the fire if this is possible without risk.



- ▷ Acquaint yourself with the position and operation of the emergency exits.
- ▷ Keep escape routes clear.
- ▷ Observe the fire extinguisher instructions for use.

All windows and doors which meet the following requirements are considered as emergency exits:

- Open to the outside or can be shifted in horizontal direction
- Opening angle at least 70°
- Minimum diameter of clearance = 450 mm
- Maximum distance from the vehicle floor = 950 mm

3.2 General



- ▶ The oxygen in the vehicle interior is used up by breathing and the use of gas operated appliances. That is why the used air must be replaced permanently. For this purpose, forced ventilation options (e.g. skylights with forced ventilation) are fitted to the vehicle. Never cover or block forced ventilations from the inside or outside with objects such as e.g. a winter mat. Keep forced ventilations clear of snow and leaves. There is a danger of suffocation due to increased CO₂ levels.
- ▶ Observe the headroom of the doors.



- ▷ As far as the fitted appliances (heater, cooker, refrigerator, etc.) and the base vehicle (engine, brakes, etc.) are concerned, the instruction manuals are authoritative. It is imperative that they be observed.
- ▷ Fitting accessories or optional equipment can alter the dimensions, weight and road behaviour of the vehicle. Some of the add-on parts must be entered in the vehicle documents.
- ▷ Only use wheel rims and tyres which are approved for the vehicle. Information concerning the size of the approved wheel rims and tyres is included in the vehicle documents or can be obtained from authorised dealers and service centres.
- ▷ Firmly apply the handbrake when parking the vehicle.



- ▷ When leaving the vehicle, it is imperative that all doors, external flaps and windows are closed.
- ▷ Always carry the legally prescribed equipment (e.g. first aid kit, warning vest, hazard warning triangle etc.) with you. The regulations of the host country apply when travelling abroad.
- ▷ The vehicle may only be driven by drivers who hold a driving licence which is valid for the respective vehicle class.
- ▷ When selling the vehicle, hand over all instruction manuals for the vehicle and the fitted appliances.

3.3 Road safety



- ▶ Before commencing the journey, carry out a functional check of indicating and lighting equipment, the steering and the brakes.
- ▶ If the vehicle has been stationary for a long period (approx. 10 months) have the braking and gas systems checked by an authorised specialist workshop.
- ▶ Before commencing the journey and after short interruptions of the journey, ensure that the entrance step is completely retracted.
- ▶ Before commencing the journey, rotate all swivel seats in the direction of travel and lock in position. During the journey, the swivel seats must remain locked in place in the direction of travel.
- ▶ Carefully store all moving parts and all loose objects before starting your journey.
- ▶ Before commencing the journey, store the flat screen securely.



- ▶ During the journey, persons are only to sit on the permitted seats (see chapter 5). The authorised number of seats is stipulated in the vehicle documents.
- ▶ Seat belts must be worn by all passengers.
- ▶ Fasten your seat belts before the beginning of the journey and keep them fastened during the journey.
- ▶ Always secure children with the children safety equipment prescribed for the respective height and weight.
- ▶ Only attach the child restraint system to seats that are specified for this purpose. If the front passenger's seat airbag is activated, only forward-facing child restraint systems may be used on the front passenger's seat.
- ▶ The base vehicle is a commercial vehicle (small truck). Adjust your driving technique accordingly.
- ▶ In case of underpasses, tunnels or similar obstacles, note the total height of the vehicle (including the roof load).
- ▶ In winter, the roof must be free of snow and ice before commencing the journey.
- ▶ Check tyre pressure before a journey or every 2 weeks. Wrong tyre pressure causes excessive wear and can lead to damage or even to tyre burst. You can lose control of the vehicle (see section 14.6).
- ▶ Do not operate the heater at petrol stations. Danger of explosion!
- ▶ Do not operate the heater in closed spaces. Danger of suffocation!



- ▷ Before commencing the journey, distribute the payload evenly within the vehicle (see chapter 4).
- ▷ When loading the vehicle and when taking a rest from driving, in order to load luggage or food, for example, observe the maximum permissible gross weight and axle loads (refer to vehicle documents).
- ▷ Before commencing the journey, ensure that all cupboard doors, the toilet compartment door and all drawers and flaps are secure. Engage the refrigerator door securing device.
- ▷ Before commencing the journey, close windows and skylights.
- ▷ Before commencing the journey, close all external flaps and lock them.
- ▷ Remove external supports (if installed) before commencing the journey.
- ▷ During the initial journey and each time after changing a wheel, retighten the wheel bolts/wheel nuts after 50 km (30 miles). Subsequently inspect them at regular intervals in order to ensure that they are firmly seated. See chapter 14 for tightening torque.
- ▷ Tyres must not be older than 6 years as the material becomes brittle over time (see chapter 14).
- ▷ When using snow chains, the tyres, wheel suspension and steering are subjected to an additional load. When using snow chains, drive slowly (maximum speed 50 km/h) and only on streets which are completely covered with snow. Otherwise the vehicle could be damaged.

3.4 Towing



- ▶ Care is to be taken when connecting and detaching a trailer. Risk of accident and injury!
- ▶ No persons are to be between the motorhome and the trailer during positioning for connecting and detaching.

3.5 Gas system

3.5.1 General instructions



- ▶ The operator of the gas system is responsible for the performance of recurring inspections and for complying with the maintenance intervals.
- ▶ Before commencing the journey, when leaving the vehicle or when the gas devices are not in use, close all gas isolator taps and the main regulator tap on the gas bottle.
- ▶ All gas-operated devices (heater, cooker) must be switched off for refuelling, on ferries or in the garage. Danger of explosion!
- ▶ Do not use gas-operated devices in closed spaces (e.g. garages). Danger of poisoning and suffocation!
- ▶ Only have the gas system maintained, repaired or altered by an authorised specialist workshop.
- ▶ Have the gas system checked by an authorised specialist workshop according to the national regulations before commissioning. This also applies for not registered vehicles. For modifications to the gas system have the gas system immediately checked by an authorised specialist workshop.
- ▶ The gas pressure regulator, the gas tubes, and the exhaust gas pipes must also be inspected. The gas pressure regulator and the gas tubes must be replaced observing the nationally defined deadlines (the latest after 10 years). The vehicle owner is responsible for seeing that this is carried out.
- ▶ In case of a defect of the gas system (gas odour, high gas consumption) there is danger of explosion! Close regulator tap on the gas bottle immediately. Open doors and windows and ventilate well.
- ▶ If the gas system is defective: Do not smoke; do not ignite any open flames, and do not operate electric switches (light switches etc.). Check the tightness of gas-conducting parts and lines with leakage search spray. Do not check with an open flame.
- ▶ Only the stipulated devices may be connected to internal connections. Do not operate any device outside the vehicle if it is connected to an internal connector.
- ▶ Cooking is prohibited during the journey.
- ▶ Before using the cooker make sure that there is sufficient ventilation. Open a window or the skylight.
- ▶ Do not use the gas cooker for heating purposes.
- ▶ If there are several gas devices, each gas device must have its own gas isolator tap. If individual gas devices are not in use, close the respective gas isolator tap.



- ▶ Ignition safety valves must close within 1 minute after the gas flame has extinguished. A clicking sound is audible. Check function from time to time.
- ▶ The built-in gas devices are exclusively meant for use with propane or butane gas or a mixture of both. The gas pressure regulator as well as all built-in gas devices are designed for a gas pressure of 30 mbar.
- ▶ Propane gas is capable of gasification up to -42 °C, whereas butane gas gasifies at 0 °C. Below these temperatures no gas pressure is available. Butane gas is unsuitable for use in winter.
- ▶ Due to its function and construction, the gas bottle compartment is a space which is open to the exterior. Never cover or block up the standard forced ventilations. Otherwise gas that is emitted can not be diverted to the outside.
- ▶ The gas bottle compartment must not be used as storage space.
- ▶ Secure the gas bottle compartment against unauthorised access. To do this, lock the compartment.
- ▶ The regulator tap on the gas bottle must be accessible.
- ▶ Only connect gas-operated devices (e.g. gas grill) which have been designed for a gas pressure of 30 mbar.
- ▶ The exhaust gas pipe must be fitted tightly to the heating system and to the vent and must be sealed. The exhaust gas pipe must not show any evidence of damage.
- ▶ Exhaust fumes must be able to escape into the atmosphere unhindered and fresh air must be able to enter unhindered. For this reason, keep the exhaust pipe and intake openings clean and unobstructed (e.g. free from snow and ice). For this reason, no snow walls or aprons may lie against the vehicle.

3.5.2 Gas bottle



- ▶ Handle full or emptied gas bottles outside the vehicle only with closed regulator tap and attached protective cap.
- ▶ Gas bottles are only to be transported within the designated gas bottle compartment.
- ▶ Place the gas bottles in vertical position in the gas bottle compartment.
- ▶ Fasten the gas bottles so that they are unable to turn or tilt.
- ▶ Connect the gas tube to the gas bottle without tension.
- ▶ If the gas bottles are not connected to the gas tube, always place the protective cap on top.
- ▶ Close the regulator tap on the gas bottle before the gas pressure regulator or gas tube are removed from the gas bottle.
- ▶ Depending on the connection, unscrew the gas tube from the gas bottle and screw it on the gas bottle again by hand or using a suitable special spanner. The screw connection on the gas bottle generally has a left-hand thread. **Do not** tighten too firmly.
- ▶ Only use special gas pressure regulators with a safety valve designed for vehicle use. Other gas pressure regulators are not permitted and cannot meet the demanding requirements.



- ▶ Use the gas pressure regulator defroster if the temperature falls below 5 °C.
- ▶ Use only 11 kg or 5 kg gas bottles. (The size of the gas bottles may vary depending on the country.)
- ▶ Use the shortest possible tube lengths (150 cm max.) for external gas bottles.
- ▶ Never block the floor ventilation openings below the gas bottles.

3.6 Electrical system



- ▶ Only allow qualified personnel to work on the electrical system.
- ▶ Prior to carrying out work on the electrical system, switch off all devices and lights, disconnect the battery and disconnect the vehicle from the mains.
- ▶ Only use original fuses with the stipulated values.
- ▶ Only replace defective fuses when the cause of the defect is known and has been remedied.
- ▶ Never bridge or repair fuses.

3.7 Water system



- ▶ Water left standing in the water tank or in the water pipes becomes undrinkable after a short period. Therefore, before each use of the vehicle, thoroughly clean the water pipes and the water tank. After each use of the vehicle completely empty the water tank and the water pipes.
- ▶ In the case of lay-ups lasting more than a week, disinfect the water system before using the vehicle (see section 12.4.3).



- ▷ If the vehicle is not used for several days or if it is not heated when there is a risk of frost, empty the entire water system. Make sure that the 12 V power supply on the panel is switched off. Otherwise, the water pump will overheat and may get damaged. Leave the water taps on in central position. Leave all drain cocks open. Frost damage to appliances, frost damage to the vehicle and deposits in water-carrying components can be avoided in this way.

Chapter overview

This chapter contains important information which has to be noted before commencing your journey or carrying out any tasks before the journey.

At the end of the chapter there is a checklist which once again summarises the most important points.

4.1 Initial start-up



- ▷ During the initial journey and each time after changing a wheel, re-tighten the wheel bolts/wheel nuts after 50 km (30 miles). Subsequently inspect them at regular intervals in order to ensure that they are firmly seated. See chapter 14 for tightening torque.

The motorhome is supplied with a set of keys, consisting of keys for the base vehicle and keys for the body.

Always deposit a replacement key outside the vehicle. Make a note of the key number. Our authorised dealers and workshops can offer assistance in case of loss.

4.2 Vehicle load capacity



- ▶ Overloading the vehicle and the axles may result, for example, in a diminished steering response (altered driving behavior), an overloading of the tires, and, as a result, an increased risk of tire blowouts or an extended braking distance. This may cause you to lose control of the vehicle, endangering yourself and other road users.
If you are not sure whether the loaded vehicle complies with the technically permissible maximum laden mass, you can weigh/check the vehicle on public scales or have it weighed by certain dealers.
- ▶ The vehicle documents state the technically permissible maximum laden mass or the mass including optional equipment ex works (actual vehicle mass), but not the weight of the laden vehicle (see section 4.2.1). For your own safety, we recommend that you have your loaded vehicle (with all passengers, luggage and personal objects) weighed on a public weighbridge before you set out on your journey.
- ▶ Adapt the speed to the payload. The stopping distance is increased if the payload is high.



- ▷ Do not exceed the technically permissible maximum laden mass (permissible total weight) and the technically permissible maximum laden mass on the axle as stated in the vehicle documents by the payload.
- ▷ Built-in accessories and optional equipment reduce the vehicle load capacity.
- ▷ Do not load the beds with point loads. The maximum permissible loads of the beds refer to a surface load.
- ▷ On loading, make sure that the payload's centre of gravity is as low as possible (directly above the floor of the vehicle). Otherwise this may affect the driving characteristics of the vehicle.



- ▷ If you drive the vehicle even though it exceeds the technically permissible maximum laden mass specified by the manufacturer, you may face legal consequences, such as a fine or loss of insurance.

Maximum permitted payloads

Description	Load (kg)
Bike rack Double	35 in total (18 per rail)
Single bed	100
Double bed (transverse rear bed)	200
Bunk bed (per bed)	100
Bed created by conversion of a seating group	70

4.2.1 Terms



- ▷ Technically speaking, the term "mass" has now replaced the term "weight". However, "weight" is still the term more frequent in common use. For better understanding, "mass" is therefore only used in the following sections for fixed formulations.

Technically permissible maximum laden mass

The technically permissible maximum laden mass is a value specified by the manufacturer that, for safety reasons, the vehicle must never exceed, even when loaded (e.g. 3500 kg). Information on the technically permissible maximum laden mass of the model you have chosen can be found in the registration papers and on the body manufacturer's nameplate in the vehicle.

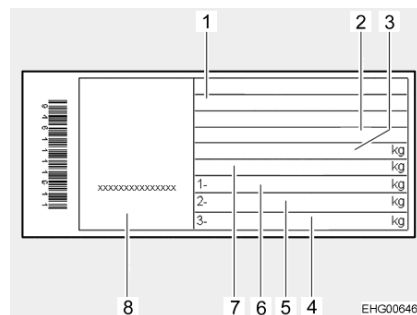

Fig. 1 Nameplate

- 1 Type
- 2 Manufacturer's code and chassis number
- 3 Technically permissible maximum laden mass of the vehicle
- 4 Free
- 5 Technically permissible maximum laden mass on rear axle
- 6 Technically permissible maximum laden mass on front axle
- 7 Technically permissible maximum laden mass of the vehicle with trailer
- 8 Serial number

The technically permissible maximum laden mass consists of the **actual vehicle mass** and the **payload**.

In the vehicle documents, the manufacturer has specified the technically permissible maximum laden mass.

Actual vehicle mass

The actual vehicle mass consists of the mass in running order and the weight of the optional equipment fitted at the factory.

Mass in running order

The mass in running order is the weight of the ready-to-drive series vehicle (excluding optional equipment fitted at the factory).

The mass in running order is made up as follows:

- Unladen weight (mass of the empty vehicle) with factory-installed standard equipment (excluding optional equipment fitted at the factory)
- Driver's weight
- Basic equipment weight
- Greases, oils and cooling liquids filled in
- Fresh water tank filled up to 100 %
- Aluminium gas bottle filled up to 100 %
- Fuel tank filled to 90 %

75 kg are calculated for the weight of the driver, regardless of how much the driver really weighs.

Basic equipment includes all equipment and fluids required for safe and proper vehicle use. The weight of the basic equipment includes:

- A full fresh water system
- A full heating system
- A full toilet flushing system
- The power cables for the 230 V power supply

The waste water and sewage tanks are empty.

The mass in running order and the actual vehicle mass are specified by the manufacturer in the vehicle documents.

Remaining load capacity

To determine the remaining load capacity, it is important that you know the actual weighed mass of your vehicle. Upon completion of your vehicle, therefore, we determine the actual weight of your vehicle for the first time by weighing it at the end of the line. This includes the mass in running order plus the weight of all ordered and factory-fitted optional equipment.

You can use this actual weighed mass to calculate the remaining load capacity for baggage or other accessories.

Example:

Technically permissible gross weight – actual weighed mass – mass of passengers = remaining load capacity

$$3500 \text{ kg} - 3000 \text{ kg} - 225 \text{ kg} (3 \times 75 \text{ kg}) = 275 \text{ kg}$$



- ▷ Please note that the factory calculation of the remaining load capacity for the mass of the driver (included in the actual weighed mass) and the mass of the passengers is based on a generalized mass of 75 kg per seat. Due to deviating body weights, however, the actual remaining load capacity of your vehicle may vary.
- ▷ The actual factory-weighed mass of your vehicle may vary slightly afterwards due to weather conditions and, for example, the associated absorption or release of moisture. Any further subsequent modification of your vehicle, e.g. through the additional installation of accessories by the dealer or other attachments and/or conversions, will additionally influence the actual weighed mass of the vehicle communicated and consequently also the remaining load capacity. It is the responsibility of the dealer after picking up the vehicle at the factory until delivery, and subsequently your responsibility from the time of handover by the dealer, to ensure that the technically permissible maximum laden mass is not exceeded. If you are not sure whether the loaded vehicle complies with the technically permissible maximum laden mass, you can weigh/check the vehicle on public scales or have it weighed by certain dealers.



- ▷ We will inform your dealer of the actual weighed mass of your vehicle and the remaining load capacity when we issue the invoice. Your dealer is required to pass on the information to you. If you have not received this information, you can contact your dealer and request it. Our scales meet all legal and standard requirements and are regularly maintained, tested and, calibrated. Nevertheless, a slight tolerance is technically unavoidable. Moreover, the weight of the vehicle may vary slightly due to weather conditions and, for example, the associated absorption or release of moisture. The actual weight of the vehicle may therefore deviate from the actual weight communicated by a few kilograms.

The payload is made up as follows:

- Conventional load
- Optional equipment
- Personal equipment



- ▷ The vehicle load capacity can be increased by reducing the actual vehicle mass. To do this, it is allowed for example to empty the fluid containers or to remove the gas bottles.

You will find explanations on the individual components of the payload in the following text.

Conventional load

The conventional load is the weight specified by the manufacturer for the passengers.

Conventional load means: 75 kg are calculated for every seat specified by the manufacturer, regardless of how much the passengers actually weigh. The driver's seat is already included in the mass in running order and must **not** be counted.

In the vehicle documents, the manufacturer specifies the number of seats.

Optional equipment

Optional equipment includes all equipment not included in the standard equipment which is fitted to the vehicle under the responsibility of the manufacturer.

- Caravan coupling
- Roof rail
- Awning
- Bike or motorcycle rack
- Satellite unit

Information about the weights of the various optional equipment devices can be obtained from the manufacturer.

Personal equipment

Personal equipment includes all items carried in the vehicle that are not included in the conventional load and optional equipment. For example, personal equipment can include the following:

- Foodstuffs
- Crockery
- Clothes
- Bedding
- Toys
- Books

- Toiletries
- Small electrical appliances (e.g. coffee machine)

No matter where kept, personal equipment also includes:

- Animals
- Bikes
- Sports equipment

For the personal equipment, according to the applicable regulations, the manufacturer must use a minimum weight that is determined according to the following formula:

Formula Minimum weight M (kg) = 10 x N + 10 x L

Explanation N = maximum number of people including the driver, as stated by the manufacturer
 L = total length of the vehicle in metres

4.2.2 Calculating the vehicle load capacity



- ▶ Never exceed the technically permissible maximum laden mass!
- ▶ The technically permissible maximum laden mass and the weight including optional equipment fitted at the factory (actual mass) is shown in the vehicle documents, but not the weight of the laden vehicle (see section 4.2.1). For your own safety, we recommend that you have your loaded vehicle (with all passengers, luggage and personal objects) weighed on a public weighbridge before you set out on your journey.

The vehicle load capacity (see section 4.2.1) is the difference in weight between

- the technically permissible maximum laden mass and
- the actual vehicle mass.

Example for calculating the payload

	Mass in kg to be calculated	Calculation
Technically permissible maximum laden mass according to vehicle documents	3500	
Actual vehicle mass including standard equipment according to the vehicle documents	- 3070	
This results in a permissible payload of	430	
Flat-rate value of 10 kg per meter vehicle length (in the example: 7.00 m)	-70	
Conventional load e.g.: 3 persons each weighing 75 kg	- 225	
Optional equipment and accessories	- 40	
For the personal pay-mass this results in	= 95	

The pay-mass is calculated based on the regulation (EC) no. 1230/2012.

The calculation of the vehicle load capacity from the difference between the technically permissible maximum laden mass and the actual vehicle mass specified by the manufacturer is however only a theoretical value.

Only if the vehicle is weighed on a public scale with filled tanks (fuel and water), filled gas bottles and complete optional equipment (and accessories) can the actual vehicle load capacity be determined.

To do this, proceed as follows:

- First only drive the vehicle on to the weighbridge with the front wheels and have it weighed.
- Then drive the vehicle on to the weighbridge with the back wheels and have it weighed.

The individual values give the current masses on the axles. These are important for the correct loading of the vehicle (see section 4.2.3). The sum of these values is the current weight of the vehicle.

The actual vehicle load capacity is the difference between the technically permissible maximum laden mass and the weighed vehicle weight.

This can be used to determine the weight that remains for the personal equipment:

- Determine the weight of the passengers and subtract it from the value for the actual vehicle load capacity.

The result is the weight that is permitted for the actual load of the personal equipment.

4.2.3 Load securing and load distribution



- ▶ For safety reasons, never exceed the technically permissible maximum laden mass.
- ▶ Distribute the load evenly on the left and right sides of the vehicle.
- ▶ Distribute the load evenly on both axles. Observe the technically permissible maximum mass on the axle specified in the vehicle documents. Observe the permissible load-carrying capacity of the tyres (see chapter 14).
- ▶ Heavy loads behind the rear axle can reduce the load on the front axle due to the leverage effect ($\frac{l_1}{l_1 + l_2}$). This applies especially to long rear extensions, if a motorbike is transported on the rear carrier or if there is a heavy load in the rear storage space. The release of the front axle negatively affects the driving quality, especially for front-driven vehicles.
- ▶ Store all objects in such a way that they cannot slip.
- ▶ Store heavy objects (awning, tin cans, etc.) close to the axles. Low-lying storage spaces whose doors do not open in the direction of travel are particularly suited for storing heavy objects.
- ▶ Stack light objects (laundry) in the roof storage cabinets.



- ▷ Only load the drawers with a maximum of 10 kg.

Large storage compartments also offer room for heavy objects. The mass on the front or rear axle may be exceeded as a result.

However, the individual axles may not be overloaded under any circumstances. That is why it is important, at which distance to the axles the load is stored.

When loading the vehicle, please observe the following instructions to ensure safe driving:

- Baggage and other items carried in the vehicle must be evenly distributed between the left and right sides of the vehicle.
- Heavy or bulky items should be stowed as close to the ground as possible in stowage boxes provided for this purpose and near the axles, and they must be secured against slipping.
- Light and other items can be stowed in lockers and storage compartments.
- Always ensure that the doors and flaps on the cabinets and storage compartments are properly secured.
- Use only suitable clamping systems to secure items against slipping. Please recheck all tie-downs before commencing travel.



- ▶ Uneven loading has a negative effect on driving behavior. A rear-heavy load in particular results in a reduction of the load on the front axle due to leverage effects and thus, for example, to a loss of traction, a diminished steering response (altered driving behavior), an overloading of the tires and, as a result, an increased risk of tire blow-outs. This may cause you to lose control of the vehicle, endangering yourself and other road users. An evenly distributed load over the entire vehicle leads to optimum driving behavior during travel.



- ▷ The technically permissible maximum laden mass and the technically permissible maximum laden mass on the axle must not be exceeded. Especially when stowing or attaching heavy accessories or heavily laden accessories (such as motorcycle carriers or bicycle carriers) at the rear, the mass on the axle must be checked and complied with. If you are not sure whether the loaded vehicle complies with the technically permissible maximum laden mass and the technically permissible maximum laden mass on the axle, you can weigh/check the vehicle on public scales or have it weighed by certain dealers.
- ▷ For individual models, a maximum load is specified by the body manufacturer for cabinets, drawers, storage compartments, or other storage spaces. This maximum load can be seen on the stickers attached on site and must be observed at all times. However, the technically permissible maximum laden mass and the technically permissible maximum laden mass on the axle must not be exceeded under any circumstances. For this reason, please note that the stated maximum load may not be fully utilized if this would result in the exceedance of the technically permissible maximum laden mass or technically permissible maximum laden mass on the axle.
- ▷ Further information on correct loading can be found in the sections "Technically permissible maximum laden mass" (page 18) and "Technically permissible maximum laden mass on the axle (mass on the axle)" (page 24).

To distribute the load correctly, you will need a scale, a tape measure, a calculator and some time.

Two simple formulas are needed to calculate the effect of the weight of the load on the axles:

Formulas $A \times G : R =$ weight on the rear axle
 Weight on the rear axle – $G =$ weight on the front axle

Explanation A = distance between storage space and front axle in cm
 G = weight of the load in the storage space in kg
 R = wheelbase of the vehicle (distance between axles) in cm



- ▷ Measure the external distances horizontally from the centre of the front wheel to the centre of the storage space or to the centre of the back wheel.

Technically permissible maximum laden mass on the axle (mass on the axle)

The technically permissible maximum laden mass on the axle or group of axles (hereafter referred to as mass on the axle) refers to the vehicle- and axle-specific load that may be transferred from the wheels of an axle or group of axles to the road surface. The mass on the axle is a value specified by the manufacturer that, for safety reasons, the vehicle must never exceed, even when loaded. You will find information on the mass on the axle of your vehicle in the registration papers and on the body manufacturer's nameplate in the vehicle.

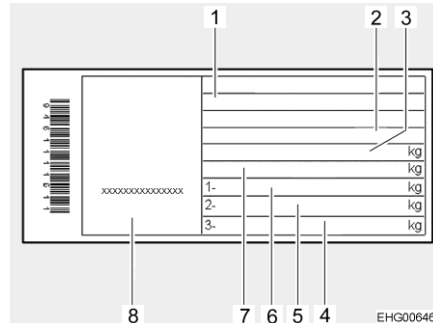

Fig. 2 Nameplate

- 1 Type
- 2 Manufacturer's code and chassis number
- 3 Technically permissible maximum laden mass of the vehicle
- 4 Free
- 5 Technically permissible maximum laden mass on rear axle
- 6 Technically permissible maximum laden mass on front axle
- 7 Technically permissible maximum laden mass of the vehicle with trailer
- 8 Serial number



- ▶ If the technically permissible maximum laden mass on the axle is exceeded, the vehicle may be damaged (e.g. due to a broken axle or tire blowout) and driving performance may be considerably impaired. This may cause you to lose control of the vehicle, endangering yourself and other road users. We therefore recommend weighing the final loaded vehicle including all passengers before commencing travel in order to ensure compliance with the mass on the axle and the technically permissible maximum laden mass at all times. For this purpose, you can weigh/check the vehicle on public scales or have it weighed by certain dealers.



- ▷ Please note that the mass on the respective axles or axle groups may differ. For this reason, please read the information provided in the registration papers carefully.
- ▷ If you drive the vehicle even though it exceeds the technically permissible maximum laden mass on the axle specified by the manufacturer, you may face legal consequences, such as a fine or loss of insurance.
- ▷ It is possible that the chassis manufacturer of your vehicle specifies a minimum load for the front axle in order to achieve optimum driving behavior. Therefore, please also always observe the information regarding this from the operating instructions of the chassis manufacturer.
- ▷ For further information on correct loading, please refer to section "Load securing and load distribution" (page 22).

Calculating masses on the axles:

- Multiply the distance between storage space and front axle (A) with the weight of the load in the storage space (G) and divide the result by the wheelbase (R). The result is the weight of the load in the storage space on the rear axle. Make a note of this weight and of the storage space.
- In a second step, subtract the weight in the storage space (G) from the weight calculated beforehand. If the result is a **positive** value (example 1), this means that the load on the front axle is **reduced** by this value. If the result is a **negative** value (example 2), this means that the load on the front axle is **increased**. Make a note of this value, too.
- Calculate all storage spaces of the vehicle in the same way.
- In a last step, add all weights calculated for the rear axle to the mass on the rear axle and add (or subtract) all weights calculated for the front axle to (from) the mass on the front axle.
How to determine the mass on the rear axle and front axle is described in section 4.2.2.

If the calculated value exceeds the permissible mass on the axle, the load must be distributed in a different way.

If the load on the front axle is too low, the grip of the tyres on the road is reduced (traction). This applies in particular to vehicles with front-wheel drive. In this case, the load must be redistributed, too.

Example calculation

		Example 1	Example 2
Distance to the front axle	A	(A1) 450 (cm)	(A2) 250 (cm)
Weight in the storage space	G	x 100 (kg)	x 50 (kg)
Wheelbase of the vehicle	R	÷ 325 (cm)	÷ 325 (cm)
Load on the rear axle (add to the axle load)		138.5 (kg)	38.5 (kg)
Weight in the storage space		- 100 (kg)	- 50 (kg)
Load relief to the front axle (subtract from the axle load)		38.5 (kg)	
Load on the front axle (add to the axle load)			-11.5 (kg)

Increase and reduction of load capacity

In the case of an increase of load capacity, a change in the chassis usually increases the technically permissible maximum laden mass of the vehicle, the technically permissible maximum laden mass on the axle and, as a result, the remaining load capacity for luggage, camping equipment, etc.

In contrast to an increase of load capacity, a reduction of load capacity reduces the technically permissible maximum laden mass of the vehicle, the technically permissible maximum laden mass on the axle and, as a result, the remaining load capacity for luggage, camping equipment, etc. As a rule, a technical modification of the chassis is not performed.



- ▷ Due to the change in the technically permissible maximum laden mass, increases or reductions of load capacity may affect the permitted seats, the chassis, and the mass on the axle. If you have any questions, feel free to contact the responsible technical testing center for advice.
- ▷ A reduction or increase of load capacity may result in changes to the legal requirements resulting from the new technically permissible maximum laden mass of the vehicle. This applies in particular to the legal requirements from the German Road Traffic Act (StVO), the German Road Vehicle Registration Regulation (StVZO), and tax and insurance regulations. An increase of technically permissible maximum laden mass to over 3500 kg may, for example, affect the driving license class or result in different speed limits or prohibitions on passing and overtaking. Toll payment requirements may also change due to the new technically permissible maximum laden mass. Therefore, inform yourself about the current legal situation with regard to the new technically permissible maximum laden mass of the vehicle and seek advice on this from the appropriate bodies. Please note that national regulations in the country of your destination and countries visited in transit may differ from those in your home country.
- ▷ For more information on the actual weighed mass of your vehicle and the remaining load capacity, please refer to section "Remaining load capacity" (page 19).

4.2.4 Rear storage space



- ▶ Uneven loading or overloading has a negative effect on driving behavior. A rear-heavy load in particular results in a reduction of the load on the front axle due to leverage effects and thus, for example, to a loss of traction, a diminished steering response (altered driving behavior), an overloading of the tires and, as a result, an increased risk of tire blowouts. This may cause you to lose control of the vehicle, endangering yourself and other road users. An evenly distributed load over the entire vehicle leads to optimum driving behavior during travel. If you are not sure whether the loaded vehicle complies with the technically permissible maximum laden mass and the technically permissible maximum laden mass on the axle, you can weigh/check the vehicle on public scales or have it weighed by certain dealers.
- ▶ When transporting vehicles powered by gasoline, diesel, gas, or other flammable material, make sure that the tank of the transported vehicle is completely empty. When transporting electric bikes, we also recommend that you remove and securely stow the battery before commencing travel.

When loading the rear storage space, please observe the following instructions to ensure safe driving:

- Baggage and items carried in the rear storage space must also be evenly distributed in accordance with the section "Load securing and load distribution" (page 22).
- All items stored in the rear storage space must be fastened and secured accordingly using suitable clamping systems at the existing fastening points provided at the factory.
- Before driving off, it must be ensured that the rear storage space is properly locked.



- ▷ Please observe the maximum permissible load of the rear storage space at all times. The specified maximum permissible load of the rear storage space may be influenced by the selection of further optional equipment, such as trailer couplings or frame extensions. However, the technically permissible maximum laden mass and the technically permissible maximum laden mass on the axle must not be exceeded under any circumstances. Especially when stowing or attaching heavy accessories or heavily laden accessories (such as motorcycle carriers or bicycle carriers) at the rear, the mass on the axle must be checked and complied with. For this reason, please note that the maximum load may not be fully utilized if this would result in the exceedance of the technically permissible maximum laden mass or technically permissible maximum laden mass on the axle.
- ▷ For further information on correct loading, please refer to the sections "Technically permissible maximum laden mass" (page 18), "Technically permissible maximum laden mass on the axle (mass on the axle)" (page 24) and "Load securing and load distribution" (page 22).

4.3 Towing



- ▶ Care is to be taken when connecting and detaching a trailer. Risk of accident and injury!
- ▶ No persons are to be between the towing vehicle and the trailer during positioning for connecting and detaching.
- ▶ Observe the permissible nose weight and rear axle load of the motorhome. Refer to the vehicle documents for the rear axle load.



- ▷ Trailer with an overrun brake: Do not connect or detach trailer with the overrun brake on.
- ▷ Caravan coupling with detachable ball neck: If the ball neck is mounted incorrectly, there is the danger of the trailer breaking away. Observe the operating manual for the caravan coupling.

4.4 Entrance step



- ▶ Before commencing the journey and after short interruptions of the journey, ensure that the entrance step is completely retracted.
- ▶ Do not step on the entrance step until it has extended completely. There is a risk of injury!
- ▶ Do not under any circumstances raise or lower persons or loads with the entrance step.



- ▷ The rocker switch to operate the entrance step is installed on the bottom right in the area of the sliding door.
- ▷ If the entrance step has not been properly retracted and locked into place, a warning tone is heard when the ignition is switched on.

The vehicles have a one-step, electrically extendable entrance step.

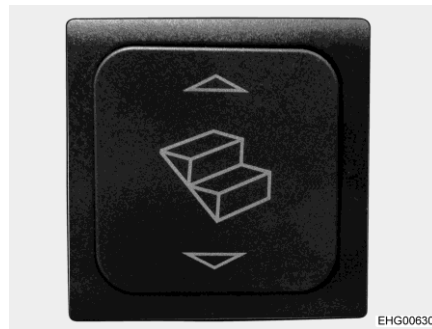

Fig. 3 Operating switch entrance step

Before stepping on the entrance step, fully extend it.

- Extending:*
- Press the rocker switch (Fig. 3,1) down until the entrance step has extended completely.
- Retracting:*
- Press the rocker switch (Fig. 3,1) up until the entrance step has retracted completely.

Emergency operation

If the entrance step does not retract electrically due to a defect, it must be pushed in by hand and secured against sliding out.



- ▷ The entrance step may only be moved by hand when the drive rods have been released.

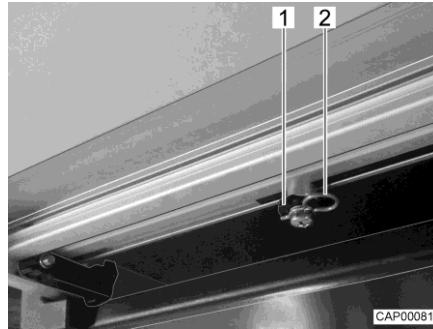

Fig. 4 Drive rod (entrance step)

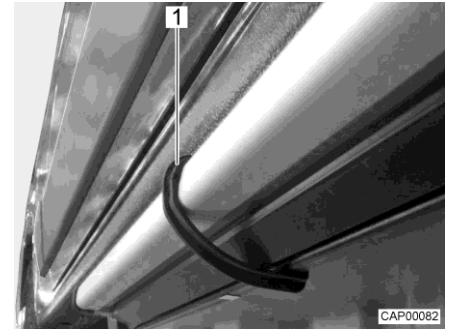

Fig. 5 Fixing clamp (entrance step)

- On the bottom of the entrance step, pull off both locking clips (Fig. 4,2) on the drive rods (Fig. 4,1).
- Release both drive rods from the retaining bolts.
- Connect drive rods with each other (e.g. with string, rubber ring). Such you prevent the drive rods from slipping into the housing.
- By hand, push the entrance step in as far as it will go.
- Secure the entrance step against sliding out using the included fixing clamp (Fig. 5,1).
- Contact a dealer or service centre.



- ▷ Further information can be obtained in the manufacturer's instruction manual.

4.5 Removable partition wall



- ▶ Insert the removable partition wall before commencing your journey. The partition wall protects against objects that can be thrown through the vehicle from the rear area.

The removable partition wall also serves as access assistance to the rear bed.



Fig. 6 Partition wall

4.6 Flat screen



- ▶ Before commencing the journey, store the flat screen securely.

4.7 Gas regulator



- ▶ Operating gas-operated appliances during the journey is permitted only if the gas system has the relevant equipment. The hose break guard and crash sensor prevent an escape of gas in the event of an accident.



- ▷ Observe the manufacturer's separate instruction manual for the gas pressure regulating system.

Depending on the equipment, different gas regulators can be installed in the vehicle.

If a gas regulator other than one of those listed below is installed in the vehicle, the regulator tap on the gas bottle and the gas isolator taps must be closed during the journey.

**Gas regulator with
crash sensor and hose
break guard**

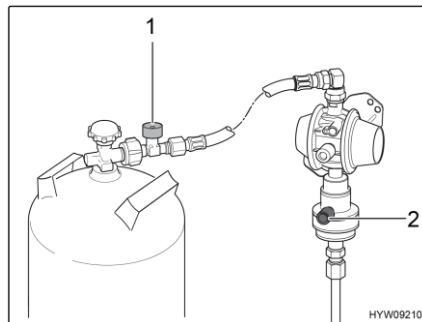

Fig. 7 Gas regulator (MonoControl)

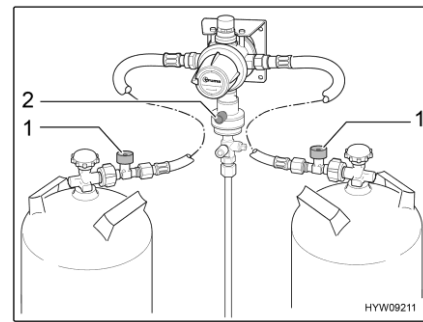

Fig. 8 Gas regulator (DuoControl)

If a gas regulator with a crash sensor (Fig. 7,2 and Fig. 8,2) and hose break guard (Fig. 7,1 and Fig. 8,1) is installed in the vehicle:

The regulator tap on the gas bottle and the "Heater" gas isolator tap may remain open during the journey. Gas-operated appliances may be on during the journey.

The design details of the MonoControl (Fig. 7) and DuoControl (Fig. 8) gas regulators can vary (straight or angled).



- ▷ If necessary, clarify questions with the authorised dealers or service centres.

4.8 Snow chains



- ▷ Only mount snow chains if there is a clearance of at least 50 mm between the tyres and the vehicle body.
- ▷ When using snow chains, the tyres, wheel suspension and steering are subjected to an additional load. When using snow chains, drive slowly (maximum speed 50 km/h) and only on streets which are completely covered with snow. Otherwise the vehicle could be damaged.
- ▷ Observe the fitting instructions issued by the manufacturer of the snow chains.
- ▷ Do not fit snow chains on alloy wheel rims.

The use of snow chains is subject to the legal regulations of the individual countries.

- Always mount snow chains to the drive wheels.
- After a few metres, check the tension of the snow chains.

4.9 Road safety



- ▶ Check tyre pressure before a journey or every 2 weeks. Wrong tyre pressure causes excessive wear and can lead to damage or even to tyre burst. You can lose control of the vehicle (see section 14.6).
- ▶ Add-on parts can be exposed to adverse conditions (storms, ice, vibrations, etc.) and require close monitoring despite careful design and manufacturing. Therefore, check the tight fit of the add-on parts at certain intervals and before long journeys.

Before commencing the journey, work through the checklist:

Base vehicle

No.	Checks	Checked
1	All vehicle documents are on board	
2	Tyres in proper condition and tyre pressure correct	
3	Vehicle lighting, brake lights and reversing lights function	
4	Oil levels for engine, gearbox and power steering controlled	
5	Coolant and fluid for windscreen washers filled up	
6	Brakes function	
7	Brakes react evenly	
8	When braking, the vehicle remains in the lane	

Housing body, outside

No.	Checks	Checked
9	Awning completely retracted	
10	Roof free of snow and ice (in winter)	
11	External connections and lines disconnected and stored away	
12	External supports removed	
13	Wheel chocks removed and stored away	
14	Entrance step retracted (observe warning tone)	
15	External flaps closed and locked	
16	Sliding door and rear door closed	
17	Awning light switched off	
18	Overall height of the vehicle including roof rack when loaded measured and noted. Keep the height information close at hand in the driver's cabin	

Housing body, inside

19	Windows and skylights closed and locked	
20	Television securely stored	
21	Television antenna retracted (if one is built in)	
22	Loose parts stored away or fixed in position	
23	Open storage spaces empty	
24	Sink cover closed	
25	Refrigerator door secured	
26	Refrigerator set to 12 V operation	
27	All drawers and flaps closed	
28	Living area doors and sliding doors secured	
29	Partition wall fitted between the bedding boxes	
30	Children's seats mounted to seats with three-point safety belts  If the front passenger's seat airbag is activated, only forward-facing child restraint systems may be used on the front passenger's seat.	
31	Swivel seat locking device for driver's seat and front passenger's seat locked	
32	Shades in the driver's cabin opened and secured	

Gas system

No.	Checks	Checked
33	Gas bottles firmly fixed in the gas bottle compartment so that they are unable to turn	
34	If the gas bottles are not connected to the gas tube, always place the protective cap on top	
35	<p>Regulator tap on the gas bottle and gas isolator taps are closed</p> <p> ▷ If there is a MonoControl or DuoControl regulating system with crash sensor installed, the gas isolator taps and the main regulator tap may remain open during the journey.</p>	

Electrical system

36	<p>Check the battery voltage of the starter and living area battery (see chapter 9). If the panel indicates that the battery voltage is too low, the respective battery will need to be recharged. Observe the notes and instructions in chapter 9</p> <p> ▷ Commence journey with fully charged starter and living area batteries.</p>	
----	--	--

Chapter overview

This chapter contains instructions on how to drive the Camper Van.

5.1 Driving the Camper Van



- ▶ The base vehicle is a commercial vehicle (small truck). Adjust your driving technique accordingly.
- ▶ Before commencing the journey and after short interruptions of the journey, ensure that the entrance step is completely retracted.
- ▶ When you start the engine, warning signals such as "entrance step extended" can sound. Under certain conditions (a cold start in winter) after the engine is started it can take up to 15 seconds for these warning signals to sound.
- ▶ A seat belt is fitted for each seat which is permitted for travel. Please keep your seat belt fastened during the journey.
- ▶ Never open your seat belts when travelling.
- ▶ Passengers must remain in the seats provided.
- ▶ The doors must remain locked.
- ▶ Avoid braking with a jerk.
- ▶ If a navigation system is used, only change the destination when the vehicle is stationary. Drive to a car park or stop in a safe area when changing the destination.
- ▶ Do not play DVDs using the monitor of the navigation system during the journey.



- ▷ Drive slowly on poor roads.



- ▷ If an accident occurs as a result of these instructions not being observed, the manufacturer will not be responsible for damages caused.
- ▷ The safety measures stipulated in chapter 3 have to be observed.

5.2 Driving speed



- ▶ The vehicle is equipped with a powerful engine. This means there are sufficient reserves in difficult traffic situations. This high power enables a high maximum speed and requires above-average driving ability.
- ▶ The vehicle provides a large contact surface for wind. A sudden crosswind can be especially dangerous.
- ▶ Uneven or one-sided loading affects road performance.
- ▶ Driving on unknown streets, you may encounter hazardous road conditions and unexpected driving situations. Therefore, in the interest of safety, make sure your driving speed is appropriate to any given driving situation and environment.
- ▶ Adhere to the national legal speed limits.



- ▷ Some add-on parts can be damaged at higher speeds:
 - If the vehicle is equipped with a Teleco satellite unit: do not drive faster than 160 km/h.
 - If the vehicle is equipped with a Heki skylight (mini or midi): do not drive faster than 160 km/h.

5.3 Brakes



- ▶ Have defects on the braking system immediately remedied by an authorised specialist workshop.

Before each journey

Before each journey, check by means of a braking test:

- Do the brakes function?
- Do the brakes react evenly?
- Does the vehicle remain in the lane when braking?

5.4 Seat belts

5.4.1 General

The vehicle is equipped with seat belts in the living area on the seats for which seat belts are compulsory by law. National regulations apply to fastening of seat belts.



- ▶ Fasten your seat belts before the beginning of the journey and keep them fastened during the journey.
- ▶ Do not damage or trap belts. Have damaged seat belts changed by an authorised specialist workshop.
- ▶ Do not alter the belt fixing devices, automatic seat belt winders and the seatbelt locks.
- ▶ Only use one seat belt for **one** adult person.
- ▶ Do not belt in objects together with persons.
- ▶ Seat belts are not sufficient for persons who are less than 150 cm tall. In these cases use additional restraining devices. Observe test certificate.
- ▶ Only attach the child restraint system to seats that are specified for this purpose. If the front passenger's seat airbag is activated, only forward-facing child restraint systems may be used on the front passenger's seat.
- ▶ After an accident, replace the seat belts (have it replaced).
- ▶ During the journey, do not tilt the backrest too far backwards. Otherwise the functionality of the seat belt is no longer guaranteed.

5.4.2 Fastening the seat belts correctly



- ▶ Do not twist the belt. The belt must be positioned smoothly against the body.
- ▶ When fastening the seat belt, adopt the correct sitting position.

The seat belt is correctly fastened when the lap belt passes below your stomach and across the hip bone. The shoulder belt must pass across the chest and shoulder (not across your neck). The belt must always be taut against your body. Any bulky or padded clothing should therefore be removed before you start your journey.

5.5 Child restraint systems



- ▶ When travelling, secure children under 13 years of age that are smaller than 150 cm, with a suitable and officially approved child restraint system.
- ▶ Fasten the children's seat belts before commencing the journey and make sure that their seat belts are kept fastened during the journey.
- ▶ If a front passenger airbag is fitted in the vehicle, do not use a child restraint system ("reboard systems") that faces the back of the front passenger's seat. Follow warning notices in the vehicle.
- ▶ Only attach the child restraint system to seats that are specified for this purpose. If the front passenger's seat airbag is activated, only forward-facing child restraint systems may be used on the front passenger's seat.
- ▶ **Never** use rearward-facing child restraints on a seat with **activated front airbag**. This may lead to **death** or to **serious injuries** in children.



HYW09354

Fig. 9 Warning notice on child restraint system (front passenger's seat sun visor)

No rearward-facing child restraint systems on the front passenger's seat

The front passenger's seat is equipped with an airbag. When this airbag is activated, it is not permitted to use a rearward-facing child restraint system on the front passenger's seat. In the event of an accident, the triggered airbag may cause serious injuries in the child or to its death. A warning notice (Fig. 9) is attached to the sun visor depicting this hazard.

The airbag of the front passenger's seat can be deactivated. Refer to the instruction manual of the base vehicle for instructions.

5.6 ISOFIX child safety seat mounting system



- ▶ Only use child restraint systems of the "Universal" category or (on seats marked with the i-Size symbol) child restraint systems of the "i-Size" category. Other child restraint systems are not permissible.
- ▶ When installing and removing a child restraint system with ISOFIX car seat fitting system, follow the manufacturer's instruction manual.
- ▶ Make sure that the child restraint system and the ISOFIX car seat fitting system have been approved according to the manufacturer's specifications for the vehicles described in this instruction manual (not required with the i-Size symbol).
- ▶ Only use child restraint systems with a support leg or with a top tether.
- ▶ Fix the top tether securely to the attachment point.
- ▶ Do not attach any other child restraint systems or belts, nor other objects to the ISOFIX retaining clips.
- ▶ If the distance between the child restraint system and the table is too small, there is the risk of the child's legs being caught. Therefore, when using a child restraint system: Lower table to bed set-up position (lift-off table) or remove table (suspension table).



The i-Size marking means:

- Child seat classes according to the i-Size standard R 129 are differentiated according to body size.
- Rear-facing child restraint systems must be used for children up to the age of 15 months.
- Higher safety standards apply to the side impact protection of the child seat.
- The child restraint system is always attached with ISOFIX.
- Unrestricted approval for all vehicle seats with i-Size marking. It is not necessary to look up the vehicle type list.

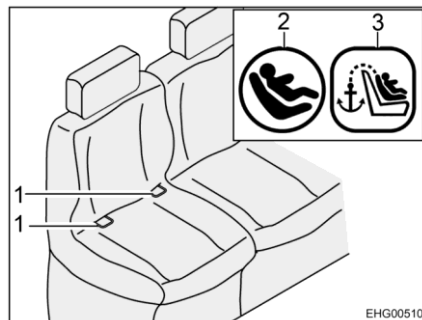

Fig. 10 Seat with ISOFIX

- 1 Retaining clip
- 2 ISOFIX symbol
- 3 Top tether symbol

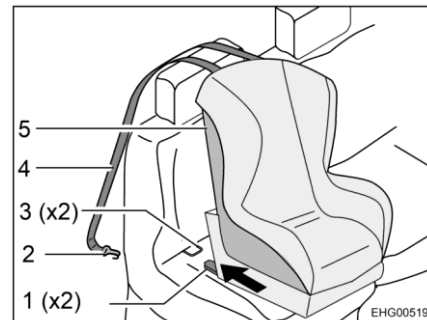

Fig. 11 Fastening with top tether

- 1 Connector
- 2 Fixing hook
- 3 Retaining clip
- 4 Top tether strap
- 5 Child seat

- Have the connectors (Fig. 11,1) snap into the retaining clips (Fig. 10,1 and Fig. 11,3). While doing this, a distinctive click must be heard.
- With a strong jerk, check if the child seat (Fig. 11,5) is firmly connected.

Child restraint systems with top tether:

- Push the headrest all the way down.
- Route top tether strap (Fig. 11,4) over the headrest of the vehicle seat.
- Hook the fixing hook (Fig. 11,2) onto the attachment point on the back of the vehicle seat.

Child restraint systems with support leg:

- Fix the support leg according to the child restraint system manufacturer's instructions.

The removal is carried out analogously in inverted order.

Child restraint systems (both category "Universal" with belt and category i-Size) may only be fitted to the following seats:

- The left-hand seat (seen in the direction of travel) on the belt rack (bench)
- The centre seat on the belt rack (bench)

5.7 Driver's seat and front passenger's seat



- ▶ Before commencing the journey, rotate all swivel seats in the direction of travel and lock in position.
- ▶ The seats must remain fixed in position during the journey and are not to be rotated.

The driver's seat and the front passenger's seat are part of the base vehicle. The adjustment of the seats is described in the operating manual of the base vehicle.

5.8 Headrests

Before commencing the journey, adjust the headrests so that the back of the head is supported at approximately ear height.

5.9 Seating arrangement



- ▶ During the journey, persons are only to sit on the permitted seats. The authorised number of seats is stipulated in the vehicle documents.
- ▶ Seat belts must be worn by all passengers.

Seats which may be used during travel are equipped with a seat belt.

5.10 Filling up with diesel



- ▶ All gas-operated devices (heater, cooker) must be switched off for refuelling, on ferries or in the garage. Danger of explosion!

The fuel filler neck is situated on the exterior of the vehicle, at the front left.

Chapter overview

This chapter contains instructions on how to pitch the vehicle at the campsite.



- ▷ Pitch the vehicle so that it is as horizontal as possible. Use ramps where necessary. Otherwise, the water from the shower tray will not be able to drain properly.
- ▷ Secure the vehicle to prevent it from rolling.
- ▷ Animals (especially mice) can cause great damage to the interior of the vehicle. To prevent this from happening, regularly check the vehicle for damages or animal traces after pitching.

6.1 Handbrake

Firmly apply the handbrake when parking the vehicle.

6.2 Entrance step

In order to exit the vehicle, first fully extend the entrance step.

6.3 Ramps



- ▷ Ramps are not included in the scope of delivery. Different models are available at the accessories shop.

To enable the vehicle to be parked on the level, ramps can be used for height compensation when the vehicle is parked on a hill or on uneven ground.

6.4 230 V connection

The vehicle can be connected to a 230 V power supply (see chapter 9).

6.5 Refrigerator



- ▷ Continuous operation of the refrigerator without external 230 V power supply can discharge the living area battery.

Check the charging condition of the living area battery on the panel. If possible, connect external 230 V power supply.

Chapter overview

This chapter contains instructions about living in the vehicle.

7.1 Doors



- ▶ Only drive with locked doors.



- ▷ Locking the doors can prevent them from opening of their own accord, e.g. during an accident.
- ▷ Locked doors also prevent forced entry, e.g. when waiting at traffic lights. However, in an emergency, locked doors make it more difficult for helpers to enter the vehicle.
- ▷ When leaving the vehicle, always lock the doors.
- ▷ The locks on the vehicle doors are a part of the base vehicle. The opening and closing of the vehicle doors is described in the instruction manual of the base vehicle.

7.1.1 Insect screen on the sliding door, extendable



- ▷ Open the insect screen completely before closing the sliding door.



Fig. 12 Insect screen

- Closing:*
- Pull out the insect screen completely by the bar (Fig. 12,1).
- Opening:*
- Push the insect screen into its initial position by the bar (Fig. 12,1).

7.1.2 Rear doors



- ▷ If the rear doors are opened too far, add-on parts on the vehicle may get damaged. The opening angle of the rear doors was limited for this reason at the factory. When releasing this limitation: continue opening the rear door only carefully and ensure that the rear door does not hit any add-on parts.

The opening angle of both rear doors is limited to approx. 90° at the factory. This limitation can be released if necessary.

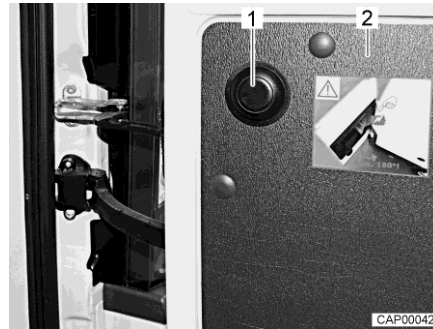

Fig. 13 Push button to release the limitation

Releasing the opening angle limitation:

- Open the rear door (Fig. 13,2) as far as it will go.
- Press the push button (Fig. 13,1), hold rear door and continue opening carefully.

7.2 External flaps



- ▷ Before commencing the journey, close all external flaps and lock them.
- ▷ To open and close the external flap, open or close all locks that are fitted to the external flap.



- ▷ When leaving the vehicle, close all external flaps.

The external flaps fitted to the vehicle are all fitted with identical locking cylinders. Therefore, all locks can be opened with a single key.

7.3 Ventilation



- ▶ The oxygen in the vehicle interior is used up by breathing and the use of gas operated appliances. That is why the used air must be replaced permanently. For this purpose, forced ventilation options (e.g. skylights with forced ventilation) are fitted to the vehicle. Never cover or block forced ventilations from the inside or outside with objects such as e.g. a winter mat. Keep forced ventilations clear of snow and leaves. There is a danger of suffocation due to increased CO₂ levels.



- ▷ Although sufficient ventilation is provided, in certain weather conditions, condensation can form on metal objects (e.g. screwed connections in the floor).
- ▷ Additional cold spots can occur at thermal "bridges" (e.g. skylight edges, filler necks, flaps, etc.).

Condensation

Ensure that there is a continuous exchange of air by providing frequent and efficient ventilation. This is the only method for ensuring that condensation is not formed during cool weather. During the colder season, a pleasant living climate is created if heating output, air distribution and ventilation are synchronised. To avoid draft close the air outlet nozzles on the dashboard and set the air distribution of the base vehicle to air circulation. If the vehicle is laid up for a longer period, occasionally ventilate it well, especially in summer as heat accumulation can occur.

7.4 Windows



- ▷ Do not keep blinds closed over a longer period of time as that can cause increased material wear.
- ▷ If the blind is completely closed, exposure to direct sunlight can cause heat to accumulate between the blind and the glass window. The window could be damaged. For that reason, close the blind only 2/3 of the way in direct sunlight.
- ▷ Before commencing the journey, close the windows.
- ▷ Depending on the weather, close the windows far enough to prevent moisture from entering.
- ▷ To open and close the hinged window, open or close all catch levers which are fitted to the hinged window.



- ▷ When leaving the vehicle, always close the windows.
- ▷ In extreme weather conditions or if the temperature fluctuates strongly, a light condensation film can form on the double-glazed acrylic glass. The glass is designed in such a way that condensation can evaporate when the external temperature increases. There is no danger of the double-glazed acrylic glass being damaged by condensation.

7.4.1 Hinged window



- ▷ If windows with automatic hinges are fitted, open the window fully in order to release the lock. If the locking device is not released and the window is closed nevertheless, there is the danger of the window breaking due to the massive counter-pressure.
- ▷ When opening the hinged windows, ensure that there are no torsional forces. Open and close the hinged windows evenly.

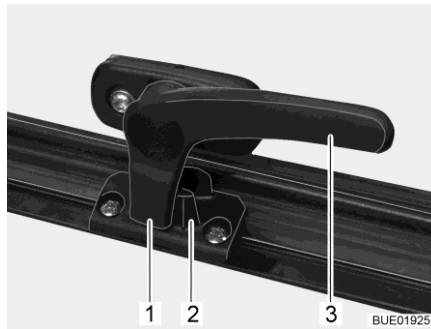

Fig. 14 Catch lever in "closed" position

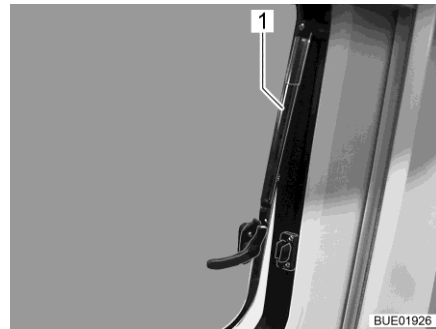

Fig. 15 Hinged window with automatic hinges, open

- Opening:*
- Turn the catch lever (Fig. 14,3) a quarter turn towards the centre of the window.
 - Open hinged window half up to the required position. Allow the hinged window to engage automatically with the automatic hinge (Fig. 15,1).
- The hinged window remains locked in the required position.

- Closing:*
- Open the hinged window as wide as necessary until the latch releases.
 - Close the hinged window.
 - Turn the catch lever (Fig. 14,3) a quarter turn towards the window frame. The locking catch (Fig. 14,1) is located on the inside of the window catch (Fig. 14,2).

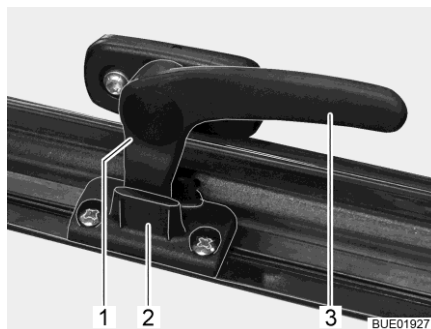

Fig. 16 Catch lever in "continuous ventilation" position

Continuous ventilation

With the catch lever, the hinged window can be placed in two positions:

- "Continuous ventilation" (Fig. 16)
- "Firmly closed" (Fig. 14).

To place the hinged window into the "continuous ventilation" position:

- Turn the catch lever (Fig. 16,3) a quarter turn towards the centre of the window.
- Slightly open the hinged window outwards.
- Turn the catch lever a quarter turn towards the window frame. The locking catch (Fig. 16,1) has to be moved into the recess of window catch (Fig. 16,2).

During the journey, the hinged window may not be in "continuous ventilation" position.

If it rains, the "continuous ventilation" hinged window position could lead to splashing water penetrating the living area. Therefore, close the hinged windows completely.

7.4.2 Roman shade and insect screen

The windows are fitted with a Roman shade and an insect screen. The insect screen and the Roman shade can be operated together or separately.

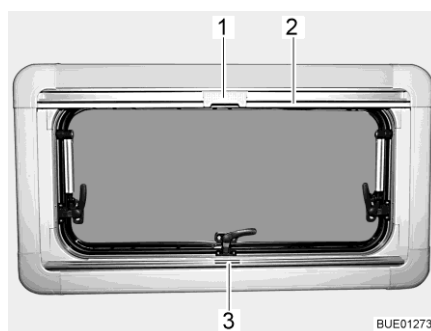

Fig. 17 Hinged window

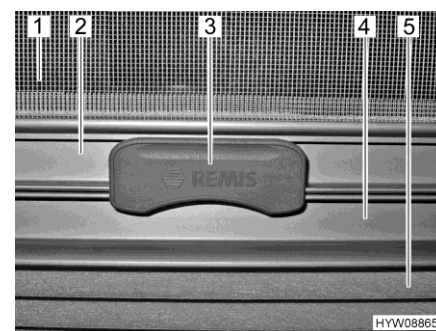

Fig. 18 Catch

Roman shade The Roman shade (Fig. 18,5) is located in the lower blind box.

Closing: ■ Seize the Roman shade by the centre of the holding bar (Fig. 17,3 and Fig. 18,4), pull it from the bottom to the top and release it at the desired height. The Roman shade will stay at this height.

Opening: ■ Grip the Roman shade in the centre of the holding bar and push it down.

Insect screen The insect screen (Fig. 18,1) is located in the upper blind box.

Closing: ■ Pull the insect screen down by the holding bar (Fig. 17,2 and Fig. 18,2), until it touches the holding bar of the Roman shade (Fig. 18,4).

■ Clip the catch (Fig. 17,1 and Fig. 18,3) on the insect screen into the holding bar of the Roman shade. When the catch is locked, the Roman shade and the insect screen can be adjusted together.

Opening: ■ Push the catch (Fig. 18,3) on the insect screen upward.

■ Move the insect screen back slowly on the holding bar (Fig. 17,2).

7.4.3 Cabin black-out shade



- ▷ Open cabin black-out shade before commencing the journey.

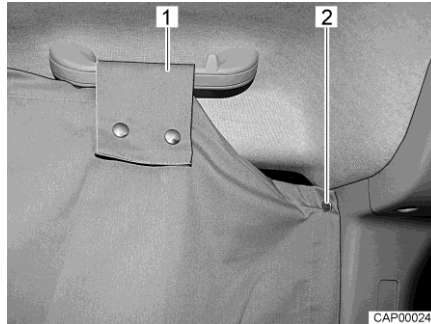

Fig. 19 Cabin black-out shade on side pane



Fig. 20 Cabin black-out shade on windscreen

- Closing:*
- Take cabin black-out shade out of the storage compartment above the driver's cabin.
 - Fasten cabin black-out shade on one side of the driver's cabin. In order to do this, fasten two snap fasteners (Fig. 19,2) behind the side pane, on the B column.
 - Guide loop (Fig. 19,1) over the handle above the side pane and fasten with snap fasteners.
 - Push pockets (Fig. 20,1) of cabin black-out shade over the two sun visors.
 - On the other side of the driver's cabin: also fasten the cabin black-out shade with loop on the handle and snap fasteners on the B column.
- Opening:*
- Release the cabin black-out shade at all fastening points.
 - Store cabin black-out shade in the storage compartment above the driver's cabin.

7.5 Skylights

Skylights with and without forced ventilation are installed in the vehicle. The smaller skylights in the living area and in the bathroom are equipped with forced ventilation.



- ▶ The apertures for forced ventilation must always be kept open. Never cover or block forced ventilations with objects such as e.g. a winter mat. Keep forced ventilations clear of snow and leaves.



- ▷ Do not keep blinds closed over a longer period of time as that can cause increased material wear.
- ▷ If the blind or the Roman shade is completely closed, exposure to direct sunlight can cause heat to accumulate between the blind/the Roman shade and the skylight. The skylight could be damaged. For that reason, close the blind/Roman shade only 2/3 of the way in direct sunlight. Open the skylight slightly or move it to ventilation position.



- ▷ Depending on the weather, close the skylights far enough to prevent moisture from entering.
- ▷ Do not climb on the skylights.
- ▷ Before commencing the journey, close the skylights.
- ▷ Before commencing the journey, check that the skylights are closed and locked.



- ▷ When leaving the vehicle, always close the skylights.
- ▷ The upholstery will fade over time, if it is exposed to sunlight. If the temperature within the vehicle rises rapidly as well, the colour will change at an accelerated rate. Therefore, we recommend closing the shades on the skylights of the parked vehicle by 2/3 when there is strong sunlight.

7.5.1 Skylight with snap latch

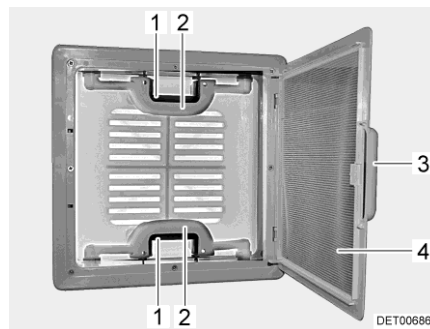

Fig. 21 Skylight with snap latch

The skylight can be pushed upwards either from one side or from both sides.

- Opening:*
- Pull on the handle (Fig. 21,3).
 - Fold insect screen (Fig. 21,4) downward.
 - Push the snap latch (Fig. 21,1) towards the inside of the skylight. At the same time use the handle (Fig. 21,2) to press the skylight upwards.
 - Swing insect screen (Fig. 21,4) upwards until it latches in place.
- Closing:*
- Pull on the handle (Fig. 21,3).
 - Fold insect screen (Fig. 21,4) downward.
 - Using both handles (Fig. 21,2), pull down the skylight with force until the two snap latches (Fig. 21,1) lock into place.
 - Swing insect screen (Fig. 21,4) upwards until it latches in place.

7.5.2 Heki skylight



- ▷ The Heki skylight can be damaged at high speeds. Therefore, do not drive the vehicle faster than 160 km/h.
- ▷ If the vehicle is to be transported: do not load the vehicle backwards. Otherwise, the Heki skylight may be damaged.

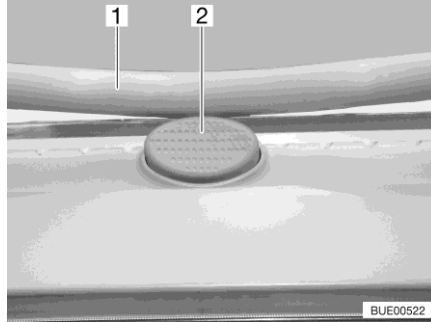

Fig. 22 Safety knob (Heki skylight)

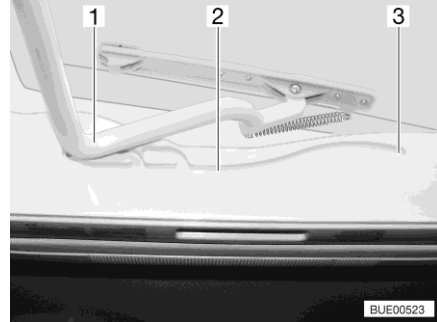

Fig. 23 Guide (Heki skylight)

The Heki skylight is opened on one side only.

- Opening:**
- Press the safety knob (Fig. 22,2) and pull the bar (Fig. 22,1) down with both hands.
 - Pull the bar (Fig. 23,1) in the guides (Fig. 23,2) to the rearmost position (Fig. 23,3).
- Closing:**
- Use both hands to push the bar (Fig. 23,1) slightly upwards.
 - Push the bar back in the guides.
 - Push the bar upwards with both hands until it is above the safety knob (Fig. 22,2).

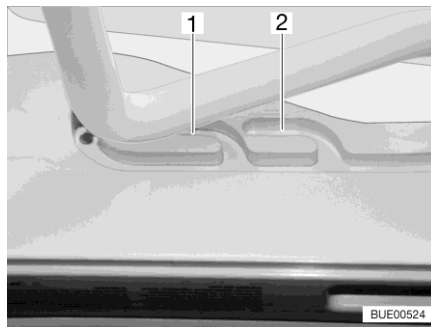

Fig. 24 Guide (ventilation position)

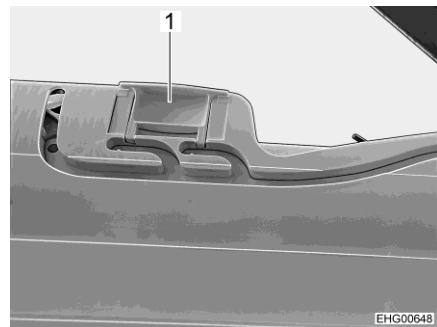

Fig. 25 Lock (ventilation position)

Ventilation position

The Heki skylight can be put in two ventilation positions: Bad weather position (Fig. 24,1) and central position (Fig. 24,2). Depending on the model, the skylight can be locked in the central position with both left and right latches (Fig. 25,1) on the skylight frame.

- Press the safety knob (Fig. 22,2) and pull the bar (Fig. 22,1) down with both hands.
- Pull the bar in the guides (Fig. 23,2) to the desired position.
- Push the bar slightly upwards and into the selected guide (Fig. 24,1 or 2) and lock if necessary.

Roman shade To close and open the Roman shade:

Closing: ■ Pull out Roman shade at the handle and release in the required position. The Roman shade will stay in that position.

Opening: ■ Slowly push the Roman shade at the handle to its initial position.

Insect screen To close and open the insect screen:

Closing: ■ Pull the insect screen by the handle to the opposite handle of the Roman shade.

Opening: ■ Press the rear part of the handle of the insect screen. The latch is released.

■ Use handle to return the insect screen slowly to its initial position.

7.6 Tables

7.6.1 Suspension table with separable support leg



▶ Before commencing the journey, remove the suspension table and fix it to the bedding box with the belt (together with the mattresses).



▷ The maximum permissible load on the swung-out table-top extension is 3 kg.



Fig. 26 Suspension table with separable support leg

The suspension table size can be enlarged by swinging out a table top extension.

Extending: ■ Pull the knob (Fig. 26,2) of the lock down and swing out the table top extension (Fig. 26,1).

Reducing size: ■ Swing the table top extension (Fig. 26,1) under the table top (Fig. 26,6) until the lock latches in place audibly.

The suspension table's separable support leg enables it to be used as a bed foundation.

Conversion into bed foundation:

- Lift the front of the table top (Fig. 26,6) by approx. 45°.
- Pull out the lower part of the support leg (Fig. 26,4) down and lay aside.
- Remove the table top from the upper retainer.
- Hook the table top at a 45° angle to the supports into the lower retainer (Fig. 26,3) and place on the floor with the upper part of the support leg (Fig. 26,5).

7.7 PVC-floor covering



- ▶ Gas pipes and electric lines are laid in the floor. Never drill holes in the floor or insert any screws. That could cause a gas explosion, an electrical shock or a short circuit due to damage to a cable.



- ▷ Shoes with pointed heels can leave permanent impressions in the PVC-floor covering. Never wear shoes with pointed heels in the vehicle.
- ▷ Rubber mats or long exposure to ketchup, carrot juice, ink, blood or lipstick can discolour the PVC-floor covering. If possible, remove stains from the floor immediately.

7.8 Lamps



- ▷ The light switches have different layouts according to the model. The light switches are located either in the entrance area, directly on the corresponding lamp or next to the lamp, e.g. in the vicinity of the seating group.

The light switches for the lamps on the ceiling of the living area are installed in the rear area and in the entrance area (at the sliding door).

7.8.1 Lighting system and USB socket



- ▶ Bulbs and lamp holders can be extremely hot.
- ▶ Allow the light bulbs and lamp holders to cool down before touching them.
- ▶ If the light is switched on or still hot, there must always be a safety distance of at least 30 cm between stores or curtains and flammable objects. Fire hazard!

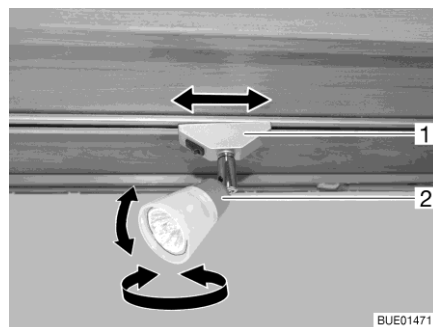

Fig. 27 Spotlight

- Turning spotlight:*
- Turn housing (Fig. 27,2) of the spotlight to the desired direction. The housing can be turned in following directions:
 - To the left and to the right
 - Up and down
- Shifting spotlight:*
- Turn holder (Fig. 27,1) through approx. 45°.
 - Shift spotlight along the rail system to the desired position.
- Removing spotlight:*
- Turn holder (Fig. 27,1) through 90°.
 - Remove spotlight from rail.

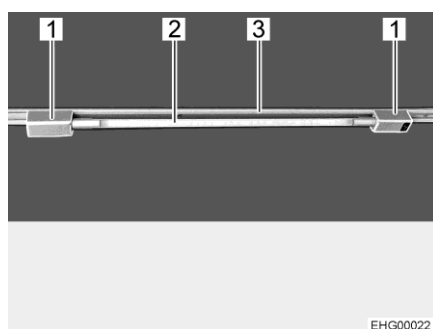

Fig. 28 Fluorescent tube

- Inserting fluorescent tube:*
- Insert both brackets (Fig. 28,1) into the rail (Fig. 28,3). In order to do this, turn bracket through 90°.
 - Plug lamp body (Fig. 28,2) into one of the brackets.
 - Shift the other bracket up to the lamp body until a firm connection has been made.
- Turning fluorescent tube:*
- Turn lamp body handle (Fig. 28,2) until the desired lighting effect is achieved.
- Removing fluorescent tube:*
- Release and shift one of the brackets away from the lamp body.
 - Remove lamp body.
 - Turn both brackets through 90° and remove from rail.

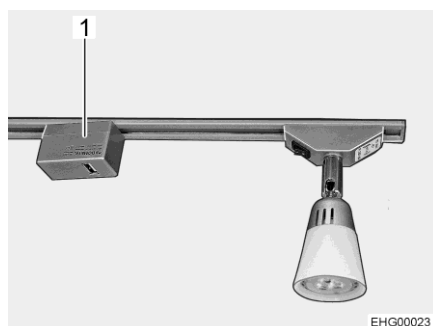

Fig. 29 USB socket element

The USB socket element (Fig. 29,1) can be inserted, turned, and removed in the same way as the spotlight.

7.8.2 Lamp in the rear area

A lamp is installed on the side in the rear area.

This lamp has 3 different switching positions:

- Off (the lamp is not lit)
- On (the lamp is lit continuously)
- Door contact (the lamp goes on when the rear door is open)



Fig. 30 Lamp, rear area

Switching on/off: ■ Press the transparent cover of the lamp on the side.

7.9 TV unit



▶ Before commencing the journey, store the flat screen securely.



▷ The information about the operation of the TV unit can be obtained in the manufacturer's instruction manual.

The flat screen is attached to a pull-out above the headrests of the bench.

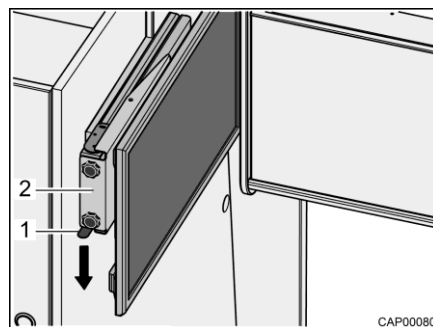

Fig. 31 Pull-out with flat screen

Bringing the flat screen into the television position:

- Press catch spring (Fig. 31,1) downwards and pull pull-out (Fig. 31,2) with flat screen out horizontally towards the centre of the vehicle.
- Rotate the flat screen into the desired position.
The flat screen can be turned such that it can also be watched from the rear area.

Bringing the flat screen into the driving position:

- Return the flat screen into its initial position.
- Push the pull-out (Fig. 31,2) with flat screen horizontally as far as it will go. The catch spring (Fig. 31,1) engages audibly.

7.10 Beds

7.10.1 Transverse rear bed



- ▶ The maximum load of the rear bed is 200 kg.
- ▶ But in particular with regard to small children less than 6 years of age, users should ensure that they cannot fall out of the bed.

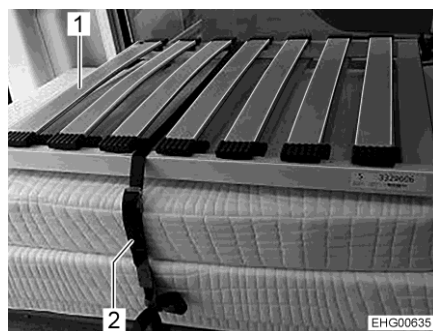

Fig. 32 Rear bed (transport position)

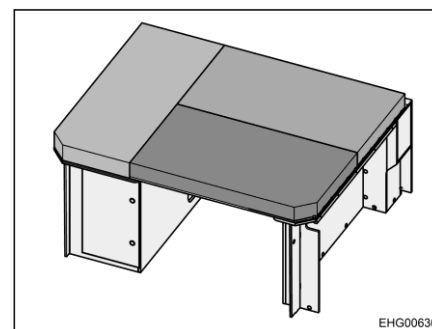

Fig. 33 Rear bed (converted for sleeping)

Conversion for sleeping:

- Release the retaining belt (Fig. 32,2).
- Place the bed bases (Fig. 32,1) one behind the other above the central aisle (on the strips on the bottom cupboard).
- Distribute the cushions on the lying surface as shown in Fig. 33.

Conversion after sleeping:

- Stack the cushions and bed bases on the left-hand bottom cupboard as shown in Fig. 32.
- Secure the cushions and bed bases with the retaining belt (Fig. 32,2). In order to do this, pull the retaining belt through the eyelets provided and loop it around the cushions and bed bases.

7.10.2 Longitudinal rear beds

Depending on the demands, the longitudinal rear beds can be converted into different situations:

- Sleeping surface
- Storage space for transporting larger objects (e.g. bicycles)



- ▷ A step unit is fitted as access assistance for the conversion into sleeping surface.



Fig. 34 Crossbeam

Conversion for sleeping: ■ Insert the crossbeam (Fig. 34,1) into the holders (Fig. 34,2).

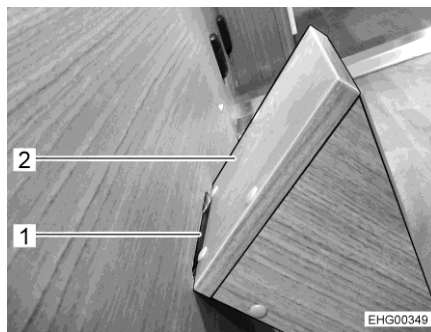

Fig. 35 Step unit

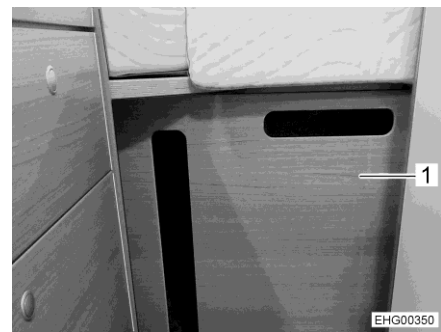

Fig. 36 Partition wall with step unit

- Attach the step unit (Fig. 35,2) to the bottom cut-out (Fig. 35,1) of the partition wall (Fig. 36,1).
- Insert the partition wall (Fig. 36,1) between the longitudinal rear beds. In order to do this, attach the partition wall in the second position (as seen from the kitchenette).



Fig. 37 Middle board



Fig. 38 Mattresses

- Lower the bed base (Fig. 37,1) on both sides.
- Attach the middle board (Fig. 37,2).
- Place the mattresses (Fig. 38) on the bed base.

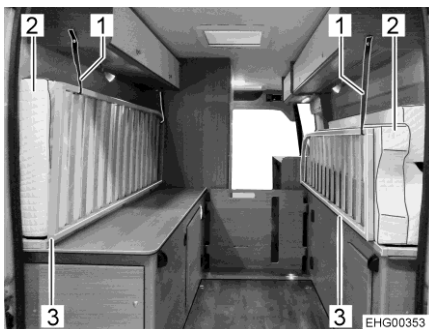

Fig. 39 Mattresses and bed bases
(transport position)

*Conversion into storage
space:*

- Remove the middle board (Fig. 37,2) and the crossbeam (Fig. 34,1) and put them on one of the mattresses.
- Fold the mattresses (with middle board and crossbeam) to the right and to the left side, see Fig. 39.
- Fold both bed bases (Fig. 39,3) up.
- Secure the mattresses (Fig. 39,2) and bed base on both sides with the retaining belt (Fig. 39,1).



Fig. 40 Fall out protection (longitudinal rear bed)



- ▷ The windows of the rear doors are equipped with a fall out protection (Fig. 40,1). The garage door can always be unlocked from the interior via the opening (Fig. 40,2).

7.10.3 Bunk bed in the rear



- ▷ Only use the bunk bed in the rear with fall out protection.

The bunk bed consists of 2 removable bed bases, 4 cushions, a fall out protection, and an attachable ladder.

The maximum permitted load on each bed base of the bunk bed is 100 kg.



Fig. 41 Bunk bed

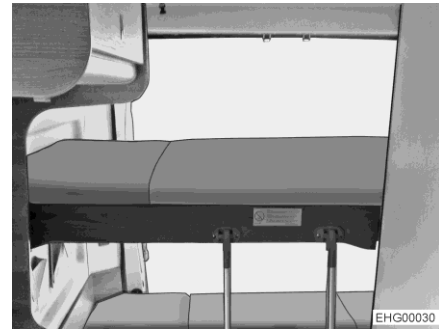

Fig. 42 Bunk bed with attached ladder

A ladder (Fig. 42) can be attached to the bunk bed to make the access to the bunk bed easier.

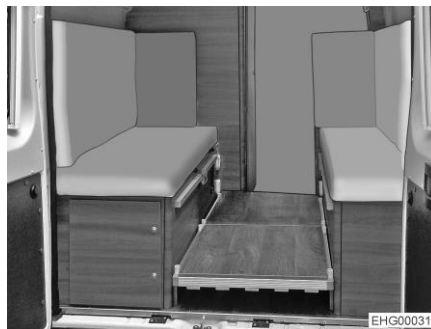

Fig. 43 Bunk bed, converted into seating group

The bunk bed can be converted into a seating group (Fig. 43). In order to do this, set the bed bases down on the clamping rails upside down, and use the cushions of the rear bed as backrests.

7.11 Converting seating group for sleeping

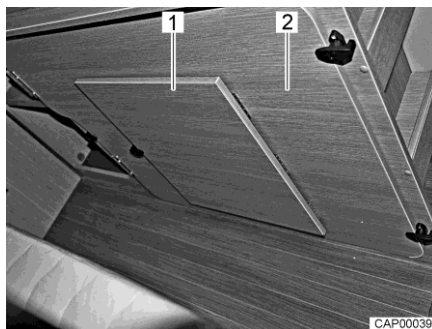

Fig. 44 Removable board on the right-hand bedding box

- Push both seats in the driver's cabin fully forwards.
- Convert the table to a bed foundation (see section 7.6.1).
- Remove additional removable board (Fig. 44,2) from the right-hand bedding box in the rear.
- Fold footrest (Fig. 44,1) out on the removable board.

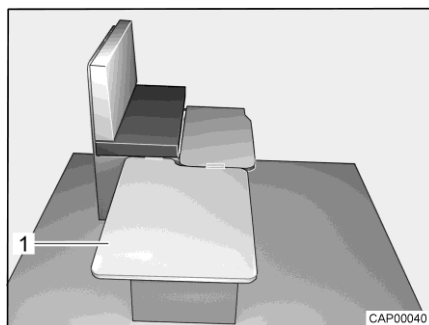

Fig. 45 During conversion

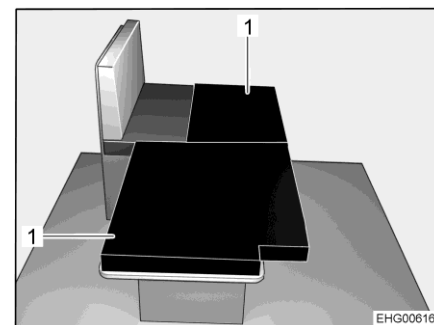

Fig. 46 After conversion

- Hook removable board (Fig. 45,1) in on the side of the bench and place it on the table.
- Place the two additional cushions (Fig. 46,1) on the lowered table as shown in the image.

7.12 Elevating roof



- ▶ In the event of a storm, do not sit or stand beneath the elevating roof. The elevating roof does not provide protection against lightning during a thunderstorm. There is danger to life!
- ▶ Never leave children under 6 years of age unattended in the elevating roof bed.
- ▶ The maximum permitted elevating roof load is 200 kg.



- ▷ Before every journey, make sure that the elevating roof is closed properly, that it cannot open by itself and that it is locked. If the elevating roof is elevated or not secured during the journey, the roof could get caught by trees, signs, masts, car park entrances, ripping off and causing severe damage to the vehicle and third party property.



- ▷ Make sure that both electrical locks are closed. Observe the warning tone if the electrical lock of the elevating roof is not fully closed.
- ▷ When the elevating roof is closed, make sure that both belt locks are closed in addition to the electrical lock. This prevents the elevating roof from opening during the journey in the event of failure or malfunction of the electrical lock.
- ▷ Only use the two U-handles to open and close the elevating roof.
- ▷ Open at least a window or the conversion door before opening or closing the elevating roof. This prevents a build-up of trapped air from forming. If an air pocket forms, the canvas can be damaged or the elevating roof cannot be opened/closed correctly.
- ▷ When opening or closing the elevating roof, ensure that the left and right sides of the elevating roof are guided up and down in parallel. In extreme cases, one-sided operation can cause the gas dampers on the side to unhinge!
- ▷ If the elevating roof has been open for a long time, there may be increased resistance from the gas dampers when closing. Close the elevating roof at least once a day.
- ▷ Only close the elevating roof when the canvas is dry. What to do if the elevating roof must be closed when the canvas is wet: Open the elevating roof again as quickly as possible and allow the canvas to dry completely.
- ▷ If the humidity in the interior is higher for an extended period, mildew and mould can form. Always provide sufficient ventilation. Openings are provided in the canvas for additional ventilation or more daylight. The canvas in these areas is either covered with a fly screen or a transparent film. Open zips or Velcro straps to ventilate.
- ▷ If, for example, moisture appears on the canvas or underneath the mattress, or condensation forms: Ventilate the elevating roof well. Remove condensation and moisture with a dry cloth already during use (but at the latest before closing).
- ▷ If the vehicle is not to be used for a prolonged period:
 - Air the interior well with the open elevating roof every 3 weeks.
 - Set up de-humidifiers (granulate). Follow the manufacturer's instructions.

Warning tone

If both electrical locks of the elevating roof are not fully locked, a warning tone sounds when the ignition is switched on.

This warning tone sounds every 2 seconds.

After 30 seconds, the warning tone increases and sounds every 0.5 seconds.

The warning tone only stops when the ignition is switched off or both electrical locks of the elevating roof are closed.

Position of push button

The push button for the electrical release (Fig. 48) is located on the right-hand side in the area above the sliding door.



- ▷ Electrical release is only possible with the ignition switched off.

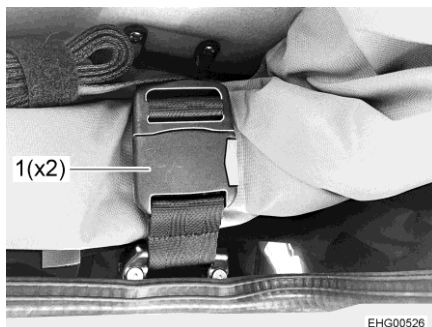

Fig. 47 Belt lock

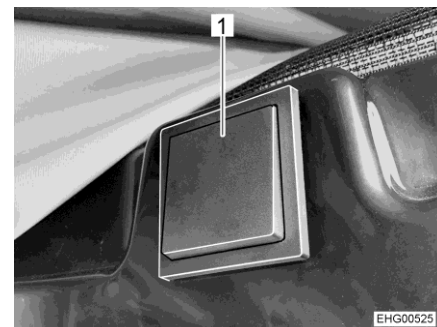

Fig. 48 Push button for electrical release

Opening the elevating roof:

- Open both belt locks (Fig. 47,1).
- Press and hold the push button (Fig. 48,1) for least 2 seconds.



- ▷ A time window of 5 seconds is provided to open the elevating roof. After the 5 seconds have elapsed, the two electrical locks are locked again.
- Press evenly against the elevating roof at both U-handles until the elevating roof swings up automatically.

Mechanical emergency release

If the electrical release fails, the elevating roof can be mechanically unlocked in an emergency.

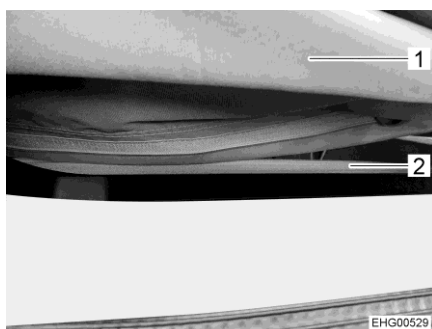

Fig. 49 Zip

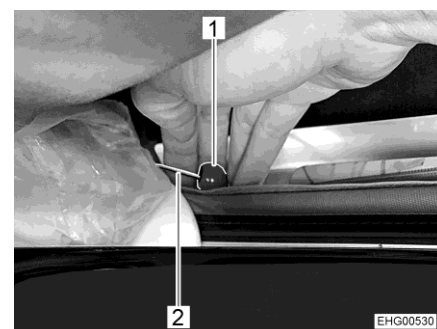

Fig. 50 Emergency release

- Fully open the zip (Fig. 49,2) on the underside of the bellows (Fig. 49,1).
- Pull the red button (Fig. 50,1) of the cable control (Fig. 50,2) on both sides.
- Push the elevating roof slightly upwards until the lock unlocks mechanically.

Access ladder



- ▶ Always use the access ladder provided to climb up to the lying surface in the elevating roof.
- ▶ The access ladder is a telescopic ladder that must be extended before use until it audibly locks.
- ▶ Before setting off, store the access ladder securely.



Fig. 51 Access ladder

Using the access ladder:

- Extend the access ladder until it audibly locks.
- Attach the access ladder to the holders provided for this purpose on the access orifice.

Storing the access ladder:

- Detach the access ladder.
- Push the access ladder together rung by rung. In order to do this, press the two red securing buttons (Fig. 51,1) under each rung.
- Store the access ladder securely.

Safety net



- ▷ Do not use the safety net for transporting or storing objects.

A safety net is attached under the mattress as fall out protection.

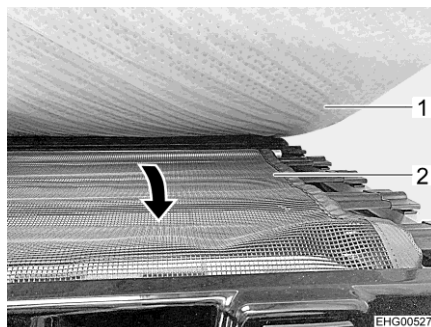

Fig. 52 Safety net

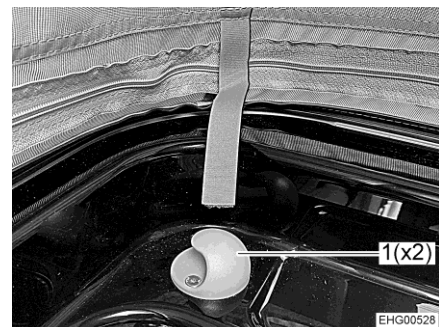

Fig. 53 Holder

- Pull out the safety net (Fig. 52,2) from under the mattress (Fig. 52,1) and stretch it over the access orifice.
- Attach the safety net to the two holders (Fig. 53,1).

Wind protection In stronger winds, the elevating roof can be additionally stiffened with two retaining belts.



Fig. 54 Wind protection

- Pull out both retaining belts (Fig. 54,1) completely.
- Attach the retaining belts diagonally to the belt locks (Fig. 54,2).
- Open the elevating roof completely.
- Tighten both retaining belts until they are slightly taut.



Fig. 55 Goose neck lamp, operating position

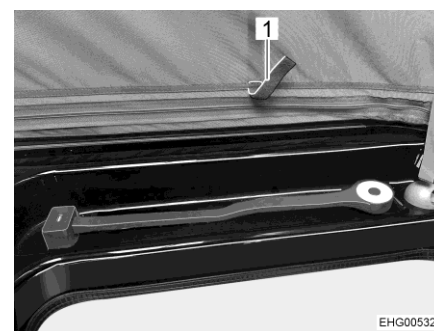

Fig. 56 Goose neck lamp, transport position

- Closing the elevating roof:*
- Before closing the bellows, always close the zips and Velcro straps on the ventilation openings.
 - Return goose neck lamp from operating position (Fig. 55) to transport position (Fig. 56).

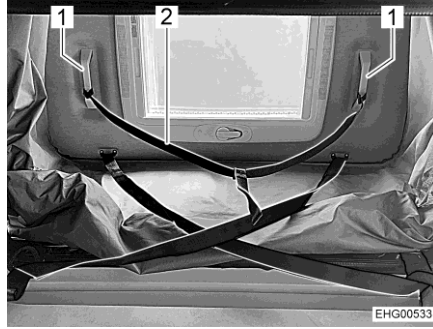

Fig. 57 Auxiliary strap



Fig. 58 Belt lock, open

- Slowly pull the elevating roof down two thirds by the auxiliary strap (Fig. 57,2) until the elevating roof stops on its own. While doing so, observe the following:
 - The left and right sides of the elevating roof must lower evenly.
 - The lateral retraction devices of the bellows must bend inwards when closing.
- If the retraction devices of the bellows are not bent inwards: Open the elevating roof again and close it more slowly.
- Pull in the canvas by the tabs (Fig. 56,1) provided for this purpose.
- Pull the elevating roof down completely using the two U-handles (Fig. 57,1) until the side locks snap in audibly.
- Roll up the canvas and store it on the side.
- Close and tighten both belt locks (Fig. 58).

Chapter overview

This chapter contains instructions regarding the gas system of the vehicle. The operation of the gas operation appliances of the vehicle is described in chapter 10.

8.1 General instructions



- ▶ The operator of the gas system is responsible for the performance of recurring inspections and for complying with the maintenance intervals.
- ▶ Before commencing the journey, when leaving the vehicle or when the gas devices are not in use, close all gas isolator taps and the main regulator tap on the gas bottle.
- ▶ All gas-operated devices (heater, cooker) must be switched off for refuelling, on ferries or in the garage. Danger of explosion!
- ▶ Do not use gas-operated devices in closed spaces (e.g. garages). Danger of poisoning and suffocation!
- ▶ Only have the gas system maintained, repaired or altered by an authorised specialist workshop.
- ▶ Have the gas system checked by an authorised specialist workshop according to the national regulations before commissioning. This also applies for not registered vehicles. For modifications to the gas system have the gas system immediately checked by an authorised specialist workshop.
- ▶ The gas pressure regulator, the gas tubes, and the exhaust gas pipes must also be inspected. The gas pressure regulator and the gas tubes must be replaced observing the nationally defined deadlines (the latest after 10 years). The vehicle owner is responsible for seeing that this is carried out.
- ▶ In case of a defect of the gas system (gas odour, high gas consumption) there is danger of explosion! Close regulator tap on the gas bottle immediately. Open doors and windows and ventilate well.
- ▶ If the gas system is defective: Do not smoke; do not ignite any open flames, and do not operate electric switches (light switches etc.). Check the tightness of gas-conducting parts and lines with leakage search spray. Do not check with an open flame.
- ▶ Only the stipulated devices may be connected to internal connections. Do not operate any device outside the vehicle if it is connected to an internal connector.
- ▶ Cooking is prohibited during the journey.
- ▶ Before using the cooker make sure that there is sufficient ventilation. Open a window or the skylight.
- ▶ Do not use the gas cooker for heating purposes.
- ▶ If there are several gas devices, each gas device must have its own gas isolator tap. If individual gas devices are not in use, close the respective gas isolator tap.
- ▶ Ignition safety valves must close within 1 minute after the gas flame has extinguished. A clicking sound is audible. Check function from time to time.



- ▶ The built-in gas devices are exclusively meant for use with propane or butane gas or a mixture of both. The gas pressure regulator as well as all built-in gas devices are designed for a gas pressure of 30 mbar.
- ▶ Propane gas is capable of gasification up to -42 °C, whereas butane gas gasifies at 0 °C. Below these temperatures no gas pressure is available. Butane gas is unsuitable for use in winter.
- ▶ Due to its function and construction, the gas bottle compartment is a space which is open to the exterior. Never cover or block up the standard forced ventilations. Otherwise gas that is emitted can not be diverted to the outside.
- ▶ The gas bottle compartment must not be used as storage space.
- ▶ Secure the gas bottle compartment against unauthorised access. To do this, lock the compartment.
- ▶ The regulator tap on the gas bottle must be accessible.
- ▶ Only connect gas-operated devices (e.g. gas grill) which have been designed for a gas pressure of 30 mbar.
- ▶ The exhaust gas pipe must be fitted tightly to the heating system and to the vent and must be sealed. The exhaust gas pipe must not show any evidence of damage.
- ▶ Exhaust fumes must be able to escape into the atmosphere unhindered and fresh air must be able to enter unhindered. For this reason, keep the exhaust pipe and intake openings clean and unobstructed (e.g. free from snow and ice). For this reason, no snow walls or aprons may lie against the vehicle.

8.2 Gas bottles



- ▶ Handle full or emptied gas bottles outside the vehicle only with closed regulator tap and attached protective cap.
- ▶ Gas bottles are only to be transported within the designated gas bottle compartment.
- ▶ Place the gas bottles in vertical position in the gas bottle compartment.
- ▶ Fasten the gas bottles so that they are unable to turn or tilt.
- ▶ Connect the gas tube to the gas bottle without tension.
- ▶ If the gas bottles are not connected to the gas tube, always place the protective cap on top.
- ▶ Close the regulator tap on the gas bottle before the gas pressure regulator or gas tube are removed from the gas bottle.
- ▶ Depending on the connection, unscrew the gas tube from the gas bottle and screw it on the gas bottle again by hand or using a suitable special spanner. The screw connection on the gas bottle generally has a left-hand thread. **Do not** tighten too firmly.
- ▶ Only use special gas pressure regulators with a safety valve designed for vehicle use. Other gas pressure regulators are not permitted and cannot meet the demanding requirements.
- ▶ Use the gas pressure regulator defroster if the temperature falls below 5 °C.



- ▶ Use only 11 kg or 5 kg gas bottles. (The size of the gas bottles may vary depending on the country.)
- ▶ Use the shortest possible tube lengths (150 cm max.) for external gas bottles.
- ▶ Never block the floor ventilation openings below the gas bottles.



- ▷ The screw connections on the gas bottles generally have a left-hand thread.
- ▷ For gas-operated units the gas pressure must be reduced to 30 mbar.
- ▷ Connect gas pressure regulator complete with safety valve directly to bottle valve.
- ▷ For filling and connecting the gas bottles in Europe the accessories shops have corresponding Euro filling sets and Euro bottle sets.
- ▷ Information available at the dealers or service centre.

The gas pressure regulator reduces the gas pressure in the gas bottle down to the operating pressure of the gas devices.

The gas pressure regulator is permanently installed in the gas bottle compartment. The gas bottle is connected to the gas pressure regulator via a high-pressure gas hose.

The high-pressure gas hoses and their connections are different in the various countries. The accessories shop offers the respective country-specific models and adapters.

8.3 Gas pressure regulating system DuoControl CS



- ▷ The regulating system and the hose lines shall be changed at the latest 10 years after manufacturing date. The operator is responsible for this.
- ▷ Also read the manufacturer's instruction manual.

DuoControl CS is a safety gas pressure regulating system with automatic switching for a two-bottle gas system and with crash sensor. The DuoControl regulating system automatically switches the gas supply from the primary bottle to the reserve bottle as soon as the primary bottle is either empty or no longer ready for operation. The gas appliances may still continue operation. The DuoControl regulating system is suitable for all commercial gas bottles with liquefied gas (propane/butane) and a pressure of 0.6 bar to 16 bar.

The DuoControl regulating system ensures a constant gas pressure for the gas-operated devices, no matter which gas bottle is supplying the gas.

In the event of an accident, the crash sensor in the DuoControl regulating system will interrupt the gas flow.

The gas bottles are connected via high pressure hoses. A hose break guard prevents gas leakage in the event of a damaged hose.

The operation of gas-operated devices during the journey is permitted in all of Europe if the vehicle is equipped with a gas pressure regulating system with crash sensor and high-pressure hoses with hose break guard.

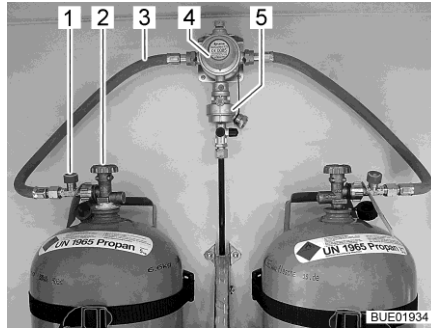

Fig. 59 Gas bottles with DuoControl

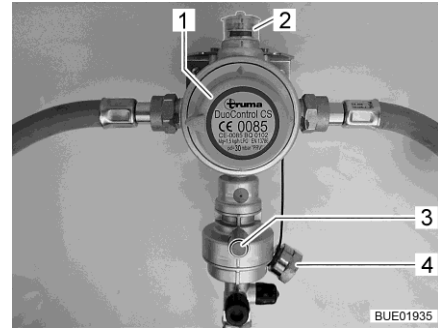

Fig. 60 DuoControl regulating system

Construction of the unit

The DuoControl regulating system consists of a reversing valve (Fig. 59,4) and a crash sensor (Fig. 59,5). The DuoControl regulating system is installed between the gas tubes (Fig. 59,3) with hose break guard (Fig. 59,1). The knob (Fig. 60,1) on the reversing valve is used to select which of the gas bottles is to be used as primary bottle and which is to be used as reserve bottle.

The status of the gas supply is indicated in the inspection window (Fig. 60,2):

- Green: Gas is taken out of the primary bottle.
- Red: Gas is taken out of the reserve bottle.

The operation with only one gas bottle is allowed but in this case the open connection must be closed with a blind cover (Fig. 60,4).

Crash sensor

The crash sensor blocks the gas supply in the event of a significant impact (e.g. accident). The crash sensor is put into operation with the green reset button (Fig. 60,3).

Hose break guard

The hose break guard (Fig. 59,1) blocks the gas flow if the connected hose breaks. The hose break guard must be activated by pressing the green button. The green button must be pressed until the pressure in the hose has built up.

Defroster

The DuoControl regulating system can be heated (defroster). If winter operation is set at the operating unit, the DuoControl regulating system will be heated automatically. Thus, faults of the gas system due to frost in winter are prevented.

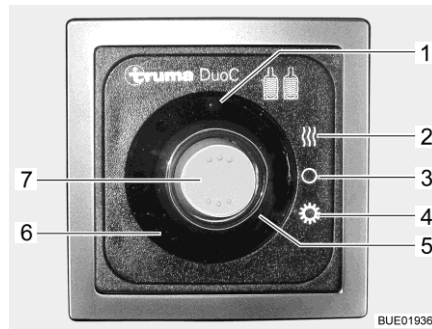

- 1 Yellow indicator lamp, defroster
- 2 Winter operation position
- 3 OFF position
- 4 Summer operation position
- 5 Red indicator lamp, primary bottle empty
- 6 Green indicator lamp, supply from primary bottle
- 7 Rocker switch

Fig. 61 Operating unit (DuoControl)

Operating unit

At the operating unit (Fig. 61), the gas supply via the DuoControl regulating system is switched on and off. The regulator taps (Fig. 59,2) of the gas bottles and the gas isolator taps of the devices must be opened manually. To activate the hose break guard, see section "Hose break guard".

Summer and winter operation are switched with the rocker switch (Fig. 61,7) on the operating unit.

The two indicator lamps on the operating unit indicate the level of the primary bottle. When the green indicator lamp (Fig. 61,6) is lit, the primary bottle is sufficiently filled. When the red indicator lamp (Fig. 61,5) illuminates, the primary bottle is empty. In this case, the reserve bottle is used for the gas supply.

Putting into operation:

- Connect the gas bottles.
- Use the knob (Fig. 60,1) on the reversing valve to select the gas bottle which is to be the primary source of gas (primary bottle). Always turn the knob as far as it will go.
- Open regulator taps (Fig. 59,2) on the gas bottles.
- Press the green button of the hose break guard (Fig. 59,1). The green marking is shown in the inspection window (Fig. 60,2).

Switching on summer/winter operation:

- Switch on the DuoControl regulating system at the operating unit (Fig. 61). To do so, set the rocker switch (Fig. 61,7) to winter operation (Fig. 61,2) or to summer operation (Fig. 61,4). The yellow defroster indicator lamp (Fig. 61,1) is lit when winter operation is selected.

Switching off:

- Set the rocker switch (Fig. 61,7) to the OFF position (Fig. 61,3). The indicator lamps go out.
- Close regulator taps (Fig. 59,2) on the gas bottles.

Changing gas bottles



- ▶ When changing gas bottles, do not smoke or create any open fire.
- ▶ When you have changed the gas bottle, check whether gas escapes at the connection points and unions. Use a leakage search spray to spray the relevant connection point or union. These agents are available at the accessories shop.
- ▶ Connect gas pipe such that it rises from the gas bottle towards the regulating system (see Fig. 62).

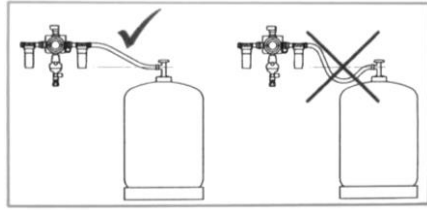

Fig. 62 Correct connection of the gas bottle

If the green indicator lamp (Fig. 61,6) goes out during operation and the red indicator lamp (Fig. 61,5) lights up, the primary bottle is empty and must be changed. The red marking is shown in the inspection window (Fig. 60,2). The reserve bottle continues supplying the gas appliances with gas.

You may also change an empty gas bottle while gas-operated devices are in operation.

Changing the gas bottle:

- Turn the knob (Fig. 60,1) a half turn in the direction of the currently used gas bottle. In this way, this gas bottle is the primary bottle now, and the empty gas bottle becomes the reserve bottle. The marking in the inspection window (Fig. 60,2) changes from red to green.
- Close regulator tap (Fig. 59,2) on the empty gas bottle. Pay attention to the direction of the arrow.
- Unscrew the gas tube from the empty gas bottle (normally a left-hand thread).
- Release the fixing belts and remove the empty gas bottle.
- Place a filled gas bottle in the gas bottle compartment and retain with the fixing belts.
- Connect gas tube to the filled gas bottle (normally a left-hand thread).
- Open the regulator tap on the gas bottle.
- Press the green button of the hose break guard (Fig. 59,1).

8.4 Changing gas bottles



- ▶ When changing gas bottles, do not smoke or create any open fire.
- ▶ When you have changed the gas bottle, check whether gas escapes at the connection points and unions. Use a leakage search spray to spray the relevant connection point or union. These agents are available at the accessories shop.



- ▷ The procedure described below applies to vehicles that are equipped with a single gas connection. If the vehicle is equipped with an regulating system: When changing the gas bottle, proceed as described for the regulating system.

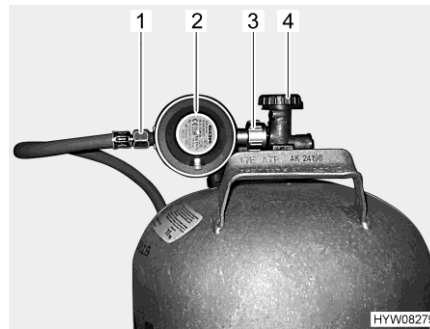
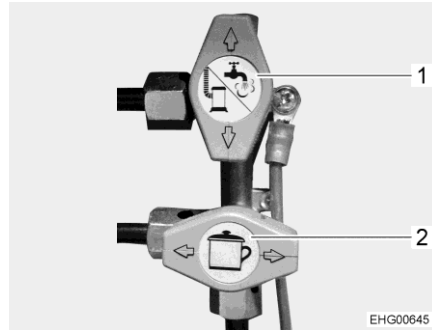

Fig. 63 Gas bottle connection

- Open flap for the gas bottle compartment.
- Close the regulator tap (Fig. 63,4) on the gas bottle. Pay attention to the direction of the arrow.
- Hold the gas pressure regulator (Fig. 63,2) and open the knurled nut (Fig. 63,3) (normally a left-hand thread).
- Remove the gas pressure regulator and the gas tube (Fig. 63,1) from the gas bottle.
- Release the fixing belts and remove the gas bottle.
- Place a filled gas bottle in the gas bottle compartment.
- Fix gas bottle in place with the fixing belts.
- Position the gas pressure regulator (Fig. 63,2) with gas tube (Fig. 63,1) on the gas bottle and tighten the knurled nut (Fig. 63,3) (normally a left-hand thread). **Do not** tighten too firmly.
- Close flap for the gas bottle compartment.

8.5 Gas isolator taps

For every gas-operated device there is a gas isolator tap installed in the vehicle. The gas isolator taps are installed on the left side in the rear area.



- 1 Heater / hot water gas isolator tap, closed
- 2 Cooker gas isolator tap, open

Fig. 64 Gas isolator taps

Opening: ■ Set gas isolator tap in the direction of the gas pipe.

Closing: ■ Set gas isolator tap perpendicular to the gas pipe.

Chapter overview

This chapter contains instructions regarding the electrical system of the vehicle.

The operation of the electrical appliances of the housing body is described in chapter 10.

9.1 General safety instructions



- ▶ Only allow qualified personnel to work on the electrical system.
 - ▶ All electronic devices (e.g. mobile telephones, radios, televisions or DVD players) which have been retrofitted to the vehicle and are operated during the journey must have certain features: These are the CE certification, the EMC inspection (electromagnetic compatibility) and the "e"-inspection.
- Only in this way can the functional reliability of the vehicle be ensured. Otherwise the airbag may be triggered or interference to the on-board electronics may result.



- ▷ During a storm, to protect the electrical devices disconnect the 230 V connection and retract the antennae.



- ▷ With the main switch on the panel, all circuits of the 12 V power supply (with few exceptions) are switched off including the charge booster. This is necessary, for example, for the WLTP test (globally standardised test procedure for determining exhaust emissions).

9.2 Terms

Off-load voltage

The off-load voltage is the voltage of the battery in idle condition, i. e. no current is consumed and the battery is not being charged.



- ▷ The battery must remain idle for a while before measuring. After charging the last time, or after the last current has been drained by appliances, wait approximately 2 hours before measuring the off-load voltage.

Closed circuit current

Some electrical appliances, such as the clock and the indicator lamps, require continuous electric current, for this reason they are referred to as inactive appliances. This closed circuit current flows even if the device has been switched off.

Total discharge

Total discharge of the battery is imminent, if a battery is completely discharged by an active appliance and by closed circuit current and the off-load voltage falls below 12 V.



- ▷ Total discharge damages the battery.

Capacity Capacity refers to the amount of electricity which can be stored in a battery. The capacity of a battery is given in ampere hours (Ah). The so-called K20 value is normally used.

The K20 value indicates how much current a battery is able to dispense over a time period of 20 hours without causing damage, or how much current is required to charge a flat battery within 20 hours.

For example, if a battery can dispense 4 amps for 20 hours, then it has a capacity of $4 \text{ A} \times 20 \text{ h} = 80 \text{ Ah}$.

If more current flows, the discharging time of the battery will decrease proportionately.

External influences, such as temperature and age may alter the storage capacity of the battery. Capacity details refer to new batteries operating at room temperature.



- ▷ Depending on battery technology, capacity details have a conversion factor of 1.3 to 1.7, which lowers the real capacity by this value.

9.3 12 V power supply



- ▷ To disconnect all electrical 12 V appliances from the power supply and prevent discharge of the living area battery, set the battery cut-off switch (Fig. 66,11) to "Batterie Aus" (battery Off) on the transformer/rectifier.

When the vehicle is not connected to the 230 V power supply or the 230 V power supply is switched off, the living area battery supplies the living area with 12 V DC. The living area battery has a limited power supply only. For this reason, electrical appliances such as the refrigerator and the heater (circulation fan) should not be operated for a long time without using the 230 V power supply.

During heater operation, the circulation fan is switched on and off by a thermostat control. As a result the living area battery is loaded if no 230 V power supply is connected.

When leaving the vehicle, switch off the electrical appliances as far as possible to conserve the energy supply of the living area battery. There are two different scenarios for this:

Variant 1 (short absence)

The vehicle is only left for a short time, the refrigerator and/or the heater should remain in operation during this time. In this case, switch off all other electrical appliances that are not needed (e.g. lighting) at their associated switches.

Variant 2 (long-term absence)

The vehicle is left for an extended period of time. In this case, switch off the 12 V main switch on the panel (see section 9.5.1). Attention: This also switches off the refrigerator! Only the basic light, the heater, the entrance step, and the satellite unit continue to be supplied electrically.

9.3.1 Living area battery Type AGM



- ▷ Disconnecting and connecting the terminals, as well as changing the living area battery shall only be carried out by qualified personnel. In the event of an incorrect connection, there is the risk of short circuit and fire due to rubbing cables. To reach the living area battery, the seat as well as its turning device must be removed. These components are security related and shall be fitted professionally with screw lock and complying with defined tightening torques.
- ▷ Prior to commencing a journey ensure the living area battery is fully charged. For this reason charge the living area battery for at least 20 hours before commencing the journey.
- ▷ During the trip, use every opportunity to charge the living area battery.
- ▷ After the trip, charge the living area battery fully.
- ▷ Charge the battery for at least 20 hours before laying up.
- ▷ Use the charger module provided on the transformer/rectifier to charge the living area battery. When charging externally, use a regulated charger that is suitable for the battery type and the capacity of the living area battery.
- ▷ For long periods of inactivity (4 weeks or more), either disconnect the living area battery from the 12 V power supply or recharge it regularly.
- ▷ When changing the living area battery, only use batteries of the same type with the same specification as the originally installed battery. Only use a different battery after authorisation by the manufacturer of the vehicle.
- ▷ Before disconnecting or connecting the terminals of the battery, switch off the vehicle engine as well as the 230 V and 12 V power supplies and all appliances. Danger of short circuit!
- ▷ Do not actuate the ignition if the terminals of the battery are disconnected. Danger of short circuit!
- ▷ Take note of the battery manufacturer's users and maintenance instructions.



- ▷ The battery is maintenance-free. Maintenance-free means:
It is not necessary to check the acid level.
It is not necessary to lubricate the battery poles.
Even a maintenance-free battery must be recharged.
Recommendation: Perform a full charging cycle every 6 to 8 weeks. Depending on the battery capacity and the charger, the charging cycle will last 24 to 48 hours.

Position The living area battery is installed in the driver's area below the right-hand seat.

Discharging The living area battery is discharged by the closed circuit current which some electrical appliances continuously require.



- ▷ Total discharge damages the battery. The consequence may be deformation, heat development, and damage due to scorching.
- ▷ Recharge battery in good time.

Note that even a fully charged living area battery can be fully discharged by closed circuit currents (inactive appliances).

Low temperatures outside reduce the capacity available.

The self-discharge rate of the battery is also dependant on temperature. At 20 to 25 °C the self-discharge rate is approx. 3 % of the capacity per month. The self-discharge rate will increase with rising temperatures: At 35 °C the self-discharge rate is approx. 20 % of the capacity per month.

An older battery no longer has the complete capacity available.

The higher the number of active electrical appliances, the faster the energy of the living area battery is consumed.



- ▷ Appliances such as the charger, the solar charge regulator, the panel, or similar, take power from the battery, even when the 12 V main switch has been switched off on the panel (Fig. 67,6). Therefore, you switch the battery cut-off switch (Fig. 66,11) on the transformer/rectifier to "Batterie Aus" (battery Off) when the vehicle is not used for a long period of time.

9.3.2 Charging batteries via a 230 V power supply

If the vehicle is connected to the 230 V power supply, the living area battery and the starter battery are automatically charged by the charger module on the transformer/rectifier. The starter battery is only charged with a float charge. The charging current is adapted to suit the charging condition of the battery. This ensures that it is not possible to overload the battery.

To make use of the maximum output from the charger module on the transformer/rectifier, switch off all electrical appliances during charging.

9.3.3 Charging batteries via the vehicle engine (alternator)

When the vehicle engine is running, the vehicle alternator recharges the living area battery and the starter battery. When the vehicle engine is switched off, the batteries are automatically disconnected from one another by a relay in the transformer/rectifier. This prevents the starter battery from being run down by electrical appliances in the living area. The starting capability of the vehicle is thus preserved. The charging condition of the living area battery or the starter battery can be read on the panel.

9.3.4 Charging the starter battery



- ▶ The acid in the battery is poisonous and corrosive. Any contact with the skin or the eyes is to be avoided. In the event of contact, rinse immediately with plenty of water (skin, eyes, clothes, objects) and seek medical attention if necessary.
- ▶ In the case of charging with an external charger there is danger of explosion. Sparks can be caused by attaching the battery terminals. Only charge the battery in a well ventilated area and away from naked flames or possible sources of sparks. Batteries can develop and release gases when they are charged.
- ▶ Always remove the starter battery from the vehicle when charging it using an external charger.



- ▷ Do not connect the battery cables to the wrong poles (red cable -> positive pole, black cable-> negative pole).
- ▷ Do not actuate the ignition if the terminals of the battery are disconnected. Danger of short circuit!
- ▷ Before disconnecting or connecting the terminals of the battery, switch off the vehicle engine as well as the 230 V and 12 V power supplies and all appliances. Danger of short circuit!
- ▷ Before charging the battery, check whether the external charger is approved for the battery type.
- ▷ Observe the instruction manuals for the base vehicle and the charger.
- ▷ Irreparable damage to the battery will result if it is overcharged.

Position The starter battery is installed in the footwell of the left-hand driver's cabin seat underneath a plastic cover.

Charging with an external charger

When charging the starter battery with an external charger, proceed as follows:

- Turn off the vehicle engine.
- Switch off all electrical appliances.
- Switch off 12 V main switch on the panel. The indicator lamp will go off.
- Switch off battery cut-off switch on the transformer/rectifier.
- Disconnect the mains plug from the transformer/rectifier.
- Switch off all gas appliances, all gas isolator taps and close the regulator tap on the gas bottle.
- Provide access to the starter battery. In order to do this, remove the plastic cover in the footwell of the left-hand driver's cabin seat.
- There is a danger of short circuit when disconnecting the battery poles. For this reason, first disconnect the negative terminal on the starter battery and then the positive.
- Remove starter battery from the vehicle.
- Check that the external charger is turned off.
- Connect the external charger to the starter battery. Pay attention to the polarity: First connect the positive terminal "+" to the positive pole of the battery, then connect the negative terminal "-" to the negative pole of the battery.
- Switch on the external charger.
- See the instructions for use of the connected charger for information concerning charge period required for the battery.
- See the specifications on the battery for information concerning its strength.
- Disconnect the external charger in reverse order.

9.3.5 Charging booster for the living area battery



- ▶ Do not carry out any maintenance or repair work on the device. There is an electrical shock hazard and risk of fire.
- ▶ If the housing or the cables are damaged: do not put the device into operation. Disconnect device from the power supply.
- ▶ Make sure that no liquids enter the device.
- ▶ Device components can get hot during operation. Do not touch the device.
Do not store any heat sensitive objects close to the device.



- ▷ Only use battery types as living area battery which are supported by the charging booster.
- ▷ In the event of a change of battery type: have the charging booster reset and re-programmed at a service centre.

During the journey, the living area battery is charged by the vehicle's alternator. Fluctuations in the charging current and a drop in voltage between the alternator and the living area battery affect the battery's performance. The charging booster is used to keep the charging current of the alternator constant and to compensate for any drops in voltage.



- ▷ The charging booster has been set in the factory for the living area battery used. The charging booster will work automatically as soon as the panel (LT 100) has been switched on. If the panel (LT 100) has been switched off, the charging booster is also inactive.

In the event of a high heat development, a built-in fan prevents the charging booster from overheating.

The fuses of the voltage sensors (1 A each) are attached to the living area battery and to the starter battery.

Position

The charging booster is installed underneath the driver's seat (behind the transformer/rectifier).

9.4 Transformer/rectifier (EBL 31)



▷ Do not cover the ventilation slots. Danger of overheating!



▷ Depending on the model, not all slots for the fuses are occupied.
 ▷ Further information can be obtained in the manufacturer's instruction manual.



Fig. 65 Position of the transformer/rectifier

Position The transformer/rectifier is installed underneath the left-hand driver's cabin seat.

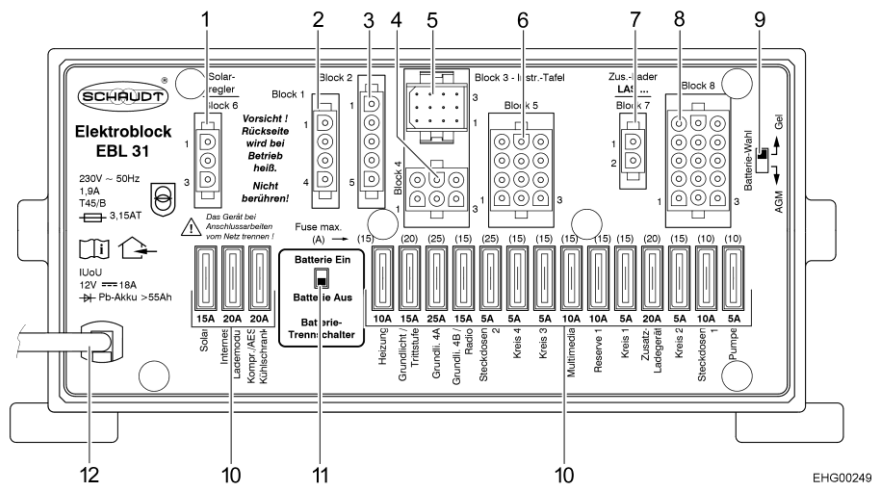

Fig. 66 Transformer/rectifier (EBL 31)

- 1 Block 6: Solar charge regulator (if fitted)
- 2 Block 1: Refrigerator
- 3 Block 2: Control lines
- 4 Block 4: Heating, basic light (lighting in the entrance area), entrance step
- 5 Block 3: Panel
- 6 Block 5: Spare, sockets, basic light
- 7 Block 7: Auxiliary charging unit
- 8 Block 8: Appliances, TV, water pump, spare, multimedia, sockets
- 9 Battery selector switch (Gel/AGM)
- 10 Fuses
- 11 Battery cut-off switch ("Batterie Ein/Aus" (battery On/Off))
- 12 Mains connection 230 V~

Functions

The transformer/rectifier has the following functions:

- The transformer/rectifier charges the living area battery. The transformer/rectifier charges the starter battery with a float charge only.
- The transformer/rectifier monitors the voltage in the living area battery.
- The transformer/rectifier distributes the current to the 12 V circuits and secures them. Devices with a maximum of 10 A can be connected to the sockets.
- The transformer/rectifier provides connections for a solar charge regulator, an auxiliary charging unit, as well as other control and monitoring functions.
- When the vehicle engine is turned off, the transformer/rectifier separates the starter battery electrically from the living area battery. This prevents the 12 V living area appliances from discharging the starter battery.
- The battery cut-off switch in the transformer/rectifier separates all the appliances from the living area battery.

The transformer/rectifier only works in conjunction with a panel.

The current provided by the internal charger module of the transformer/rectifier is limited to 18 A and is divided into charging current and current to the appliances.

9.4.1 Battery cut-off switch

- ▷ After switching the battery cut-off switch back on again: Put the basic light (lighting in the entrance area), entrance step, heater and spare 4 back into service (depending on the model). To do so, switch on the 12 V main switch briefly. This also applies if the living area battery was disconnected and then reconnected.

The battery cut-off switch disconnects all the living area 12 V appliances. This prevents the living area battery from slowly discharging if the vehicle is not used for a longer period of time (e.g. temporary lay-up).

The batteries can still be charged by the transformer/rectifier when the battery cut-off switch is turned off.

Switching on/off:

- Push the battery cut-off switch upwards: Battery On ("Batterie Ein").
- Push the battery cut-off switch downwards: Battery Off ("Batterie Aus").

9.4.2 Battery selector switch

- ▶ If the battery selector switch is set incorrectly, there is a risk of generating oxyhydrogen gas. Danger of explosion!



- ▷ Incorrect setting of the battery selector switch damages the living area battery.
- ▷ The factory settings of the battery selector switch must not be changed.

Position

The battery selector switch is located on the transformer/rectifier.

9.4.3 Battery monitor



- ▷ You must fully recharge a discharged living area battery as soon as possible.

The battery monitor in the transformer/rectifier monitors the voltage in the living area battery.

If the voltage of the batteries falls below 10.5 V, the battery monitor in the transformer/rectifier switches off all the 12 V appliances.

- Measures:*
- Switch off all electrical appliances that are not absolutely essential at the corresponding switch.
 - If necessary, use the 12 V main switch to switch the 12 V power supply back on for a short while. This is only possible, however, when the battery voltage is above 11 V. If the voltage is below this level, the 12 V power supply cannot be switched on again until the living area battery has been recharged.

9.4.4 Charging the battery

When the vehicle engine is running, a relay in the transformer/rectifier alternator switches on the living area battery and the starter battery together and recharges them with the vehicle generator. When the vehicle engine is switched off, the batteries are automatically disconnected from one another again by the transformer/rectifier. This prevents the starter battery from being run down by electrical appliances in the living area. The starting capability of the vehicle is thus preserved. The terminal voltage of the living area battery or the starter battery can be read on the panel.

If the vehicle is connected to the 230 V power supply via the CEE socket outlet, the living area battery and the starter battery are charged by the charger module on the transformer/rectifier. The starter battery is only charged with a float charge. The charging current is adapted to suit the charging condition of the battery. This ensures that it is not possible to overload the battery.

To make use of the maximum output from the charger module on the transformer/rectifier, switch off all electrical appliances during charging.

9.4.5 Assignment of the "SAT preparation" cable

Assignment on the transformer/rectifier EBL

Wire colour	Signal	Connection
Black	D+	Plug-in distributor, row 6, purple
Brown	Positive	Block 5 / pin 9 (fuse for basic light, 15 A)
White	Minus	Block 5 / pin 12

9.5 Panel (LT 100)

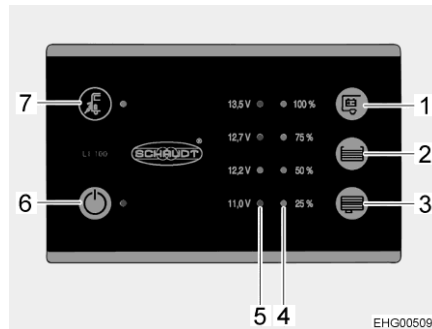

Fig. 67 Panel (LT 100)

- 1 Button to query the voltage of the living area battery
- 2 Button to query the fill level in the fresh water tank
- 3 Button to query the fill level in the waste water tank
- 4 LED array to display the tank fill level
- 5 LED array to display the battery voltage
- 6 12 V main switch and green LED
- 7 Mains connection symbol and yellow LED

The switches and push buttons of the panel are sensor touchpads. The switching function is triggered by touching.

Mains connection

The yellow LED at the mains connection symbol "⚡" (Fig. 67,7) is lit when the vehicle is connected to an external mains supply. In this case, the LED will also be lit when the panel is switched off.

9.5.1 12 V main switch

The 12 V main switch (Fig. 67,6) switches the panel and the 12 V power supply of the living area on and off.

Exception: Depending on the model, the basic light (lighting in the entrance area), the heater, the satellite unit, and the entrance step remain ready to operate.

Switching on:

- Press switch "⏻" (Fig. 67,6): The 12 V living area power supply is switched on. The LED lights up green.

Switching off:

- Press switch "⏻" (Fig. 67,6) again: The 12 V living area power supply is switched off. The LED goes out.



- ▷ When leaving the vehicle, switch off the main 12 V power supply at the panel. This prevents any unnecessary discharge of the living area battery.
- ▷ Appliances, such as control units (e.g. solar charge regulator or panel) or fitted appliances (e.g. entrance step) continue to take power from the battery capacity, even if the 12 V power supply on the panel is switched off. Therefore disconnect the living area battery from the 12 V power supply via the switch on the transformer/rectifier if the vehicle will not be used for a long period of time.

9.5.2 LED array for battery voltage

The LED array (Fig. 67,5) displays the battery voltage of the living area battery as follows:

- All LEDs light up: Battery is sufficiently charged.
- Yellow and red LED are lit: Battery is partly discharged.
- Only red LED is lit: Battery is discharged.
- Red LED flashes: Battery is fully discharged.

Displaying the battery voltage:

- Press the button " " (Fig. 67,1): The battery voltage of the living area battery is displayed.

The following tables will help you correctly interpret the battery voltage of the living area battery displayed on the panel.

Battery voltage (values during operation)	Mobile operation (vehicle moving, no mains connection)	Battery operation (vehicle stationary, no mains connection)	Power operation (vehicle stationary, mains connection)
Below 11.0 V (red LED is flashing)	Battery is totally discharged, no charging via the alternator	Battery is fully discharged	Battery is totally discharged, no charging via the power supply
12.2 V or less Danger of total discharge (battery alarm) (red LED is lit)	12 V power supply overload	If appliances are switched off: Battery flat	12 V power supply overload
	The battery is not charged by the alternator	If appliances are switched on: Battery overload	The battery is not charged by the transformer/rectifier, the transformer/rectifier is defective
12.7 V to 13.5 V (red, yellow, and green LED are lit)	12 V power supply overload ¹⁾	Normal range	12 V power supply overload ¹⁾
	The battery is not charged by the alternator ¹⁾		The battery is not charged by the transformer/rectifier, the transformer/rectifier is defective ¹⁾
13.5 V (all LEDs are lit)	Battery being charged	Occurs only briefly after charging	Battery being charged

¹⁾ If the voltage does not exceed this range for several hours.

Off-load voltage

Measuring the off-load voltage is a simple method to check the condition of the battery. The off-load voltage is the voltage of the battery in idle condition, when current is neither supplied nor consumed.

The following table helps to correctly interpret the displayed battery off-load voltage. The specified values are guide values for dryfill batteries.

LT 100 indicator	Off-load voltage values	Battery charge
Red LED flashes	11.0 V or less	Battery is fully discharged
Red and yellow LED are lit	11.0 V to 12.2 V	Battery is discharged to totally discharged
Red and yellow LED are lit	12.2 V to 12.7 V	Battery is empty or charged up to approx. 50 %
Red, yellow, and lower green LED are lit	12.7 V to 13.5 V	Battery is charged from approx. 50 % to fully charged
All LEDs light up	Above 13.5 V	(Only appears while charging)



- ▷ Total discharge causes irreparable damage to the battery.

- Measures:*
- When the battery alarm comes on, switch off the appliances and charge the living area battery, either by mobile operation or by connection to a 230 V power supply.

9.5.3 LED array for tank fill level

The LED array (Fig. 67,4) displays the fill level of the fresh water tank or of the waste water tank.

Display fill level: Press the button "☰" (Fig. 67,2): The fill level of the fresh water tank is displayed by lit LEDs.

Press the button "☷" (Fig. 67,3): The fill level of the waste water tank is displayed by lit LEDs.

Level indicator

LED indicator	Tank fill level
All LEDs light up	Full tank
3 LEDs light up	Tank approx. 3/4 full
2 LEDs light up	Tank approx. 1/2 full
1 LED lights up	Tank approx. 1/4 full
Bottom LED flashes	Tank empty



- ▷ Further information can be obtained in the manufacturer's instruction manual.

9.6 230 V power supply



- ▶ Only allow qualified personnel to work on the electrical system.
- ▶ Have the vehicle's electrical system checked by a qualified electrician at least once every 3 years. If the vehicle is used frequently, an annual check is recommended.

The 230 V power supply provides electricity for:

- sockets with earth contact for appliances with maximum 10 A
- transformer/rectifier

The electrical appliances connected to the 12 V power supply of the living area are supplied with voltage by the living area battery.

Connect the vehicle to an external 230 V power supply system as often as possible. The charger module in the transformer/rectifier automatically charges the living area battery. In addition to this, the starter battery is charged with a float charge.

9.6.1 230 V connection (CEE socket outlet)



- ▷ Overvoltage can damage connected devices. Overvoltage can be caused by lightning, irregular voltage sources (e.g. petrol-operated generators) or power connections on ferries for example.

Requirements concerning the 230 V connection

- The connecting cable, the plug connectors at the point of supply and the plug connector to the vehicle must comply with IEC 60309. The standard designation for the plug connectors is "CEE blue".
- Use H07RN-F rubber sheathed cable with a minimum cable cross-section of 2.5 mm² and a maximum length of 25 m.
- Earth contact connectors (safety) are not permitted. The interconnection of CEE/safety adapters is also prohibited.

9.6.2 Connecting the 230 V power supply



- ▶ The external 230 V power supply must be protected by fuse with a fault current protection switch (FI-switch, 30 mA).
- ▶ To prevent overheating, the cable must be fully uncoiled from the cable reel.
- ▶ In case of doubt or if the 230 V supply is not available or is faulty, contact the operator of the power supply device.



- ▷ The 230 V connection in the vehicle is equipped with a fault current protection switch (FI-switch).
- ▷ For the connection points on camp sites (camping distributors) fault current protection switches (FI-switches, 30 mA) are obligatory.

The vehicle can be connected to an external 230 V power supply. As a principle, only use the 230 V connection on the vehicle (CEE socket outlet) for connecting.

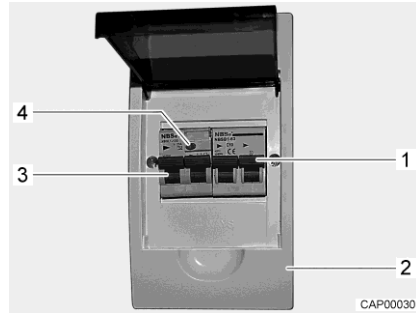

Fig. 68 Safety cut-out and FI-switch (230 V fuse box)



Fig. 69 230 V connection on the vehicle (CEE socket outlet)

Connecting the vehicle:

- Check whether the power supply device is suitable regarding connection, voltage, frequency and current.
- Check whether the cables and connections are suitable.
- Check the plug connectors and cables for visible damage.
- Switch off the safety cut-out (Fig. 68,1) in the fuse box (Fig. 68,2).
- Open the cover of the 230 V connection on the vehicle (Fig. 69) and insert the plug connector. Ensure that the detent of the spring-mounted pivoting cover is engaged in position.
- Plug the connector of the connecting cable into the socket of the camping distributor. Ensure that the detent of the spring-mounted flap is also engaged here.
- Switch on the safety cut-out in the fuse box.

Checking the fault current protection switch:

- When the vehicle is connected to the 230 V supply, press the test button (Fig. 68,4) of the fault current protection switch (FI-switch) (Fig. 68,3) in the fuse box (Fig. 68,2). The fault current protection switch must trip.
- Switch the fault current protection switch (Fig. 68,3) back on again.

Unplugging the connection:

- Switch off the safety cut-out (Fig. 68,1) in the fuse box (Fig. 68,2).
- Loosen the detent on the camping distributor and unplug the connecting cable from the socket.
- Loosen the detent on the vehicle unplug the plug connector and close the cover of the 230 V connection.

9.7 Fuses



- ▶ Only replace defective fuses when the cause of the defect is known and has been remedied.
- ▶ Replace defective fuses only after the power supply has been turned off.
- ▶ Never bridge or repair fuses.
- ▶ Only replace faulty fuses with a new fuse with the same rating.

9.7.1 12 V fuses

The appliances connected to the 12 V power supply in the living area are fused individually. The fuses are accessible at different positions in the vehicle.

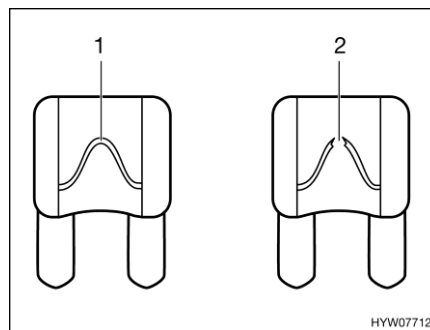

- 1 Unbroken fuse element
- 2 Broken fuse element

Fig. 70 12 V fuse

An intact 12 V fuse can be detected by the unbroken fuse element (Fig. 70,1). If the fuse element is broken (Fig. 70,2), change the fuse.

Before changing fuses, take the function, value and colour of the relevant fuses from the following specifications. When changing fuses, only use flat fuses with the values shown below.

Fuses on the starter battery

The fuses are installed in the vicinity of the starter battery. The starter battery is on the floor between the seats in the driver's cabin and can be accessed under a cover.

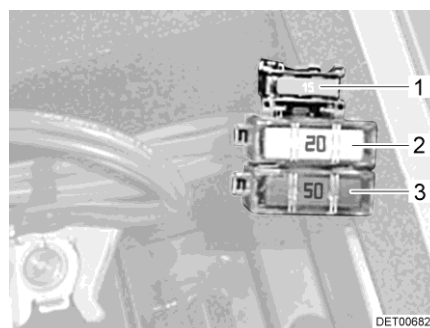

- 1 Flat fuse 15 A/blue (control for relay)
- 2 Jumbo flat fuse 20 A/yellow (back-up fuse for refrigerator)
- 3 Jumbo flat fuse 50 A/red (fuse protection for starter battery)

Fig. 71 Fuses on the starter battery without charging booster

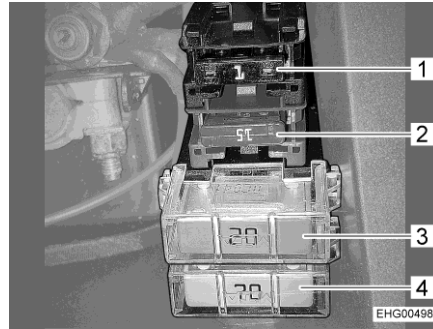

Fig. 72 Fuses on the starter battery with charging booster

- 1 Flat fuse 1 A/black (voltage sensor for starter battery)
- 2 Flat fuse 15 A/blue (control for relay)
- 3 Jumbo flat fuse 20 A/yellow (starter battery for refrigerator)
- 4 Jumbo flat fuse 70 A/beige (fuse protection for starter battery)

Fuses on the living area battery

The fuses are installed in the seat console of the right-hand driver's cabin seat.

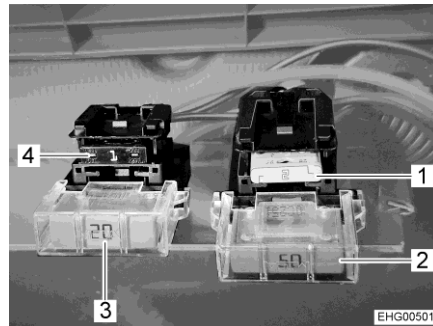

Fig. 73 Fuses on the living area battery with charging booster

- 1 Flat fuse 2 A/grey (voltage sensor for transformer/rectifier)
- 2 Jumbo flat fuse 50 A/red (fuse protection for living area battery)
- 3 Jumbo flat fuse 20 A/yellow (living area battery for refrigerator)
- 4 Flat fuse 1 A/black (voltage sensor for living area battery)

If the vehicle is **not** equipped with a charging booster, the following fuses are located on the living area battery:

- Flat fuse 2 A/grey (voltage sensor for transformer/rectifier)
- Jumbo flat fuse 20 A/yellow (living area battery for refrigerator)
- Jumbo flat fuse 40 A/orange (fuse protection for living area battery)

Fuse for plus signal "Ignition on, vehicle"

The fuse for the positive signal "Ignition on, vehicle" is installed on the B column on the right-hand side of the vehicle.

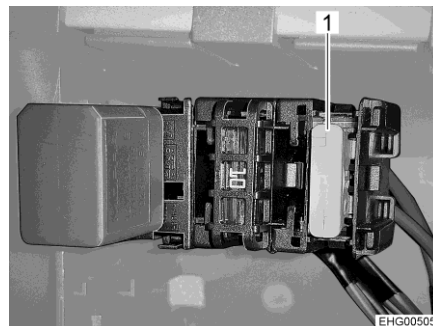

Fig. 74 Fuse on B column, right-hand side of vehicle

- 1 Flat fuse 2 A/grey (positive signal "Ignition on, vehicle")

The fuse is accessible behind a cover.

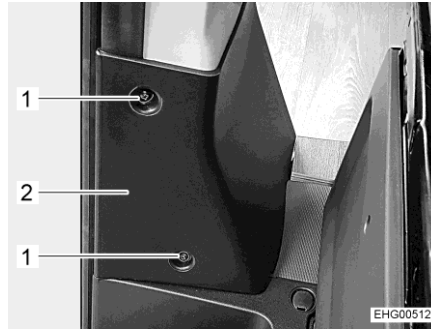

Fig. 75 Cover (seen from driver's cabin door)



Fig. 76 Cover (seen from sliding door)

Replacing fuse:

- Unscrew 2 screws (Fig. 75,1) and 2 screws (Fig. 76,2) and remove cover (Fig. 75,2 and Fig. 76,3) from B column (Fig. 76,1).
- Replace fuse.
- Position the cover on the B column and fix it with 4 screws.

Fuse for the Thetford toilet

The toilet has a maintenance-free fuse which resets automatically.

9.7.2 230 V fuse



- ▷ Check the fault current protection switch for each connection to the 230 V power supply, at least once every 6 months.

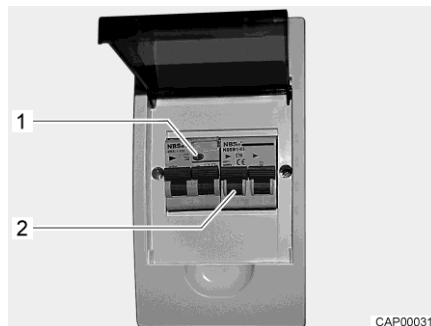

Fig. 77 230 V fuse box with safety cut-out and FI-switch

A fault current protection switch (FI-switch) in the fuse box protects the complete vehicle from fault current (0.03 A). A downstream safety cut-out (10 A) (Fig. 77,2) secures the 230 V power supply.

Checking the fault current protection switch:

- When the vehicle is connected to the 230 V power supply, press the test button (Fig. 77,1). The fault current protection switch must trip.

Position

The fuse box is installed behind the service flap in the seat box.

Chapter overview

This chapter contains instructions regarding the appliances of the vehicle.

The instructions refer exclusively to the operation of the appliances.

Further information about the appliances can be found in the instruction manuals for the appliances, included separately with the vehicle.

10.1 General



- ▷ For safety reasons, spare parts for pieces of heating appliances must correspond with manufacturer's instructions and be permitted by the manufacturer as a spare part. These spare parts may only be fitted by the manufacturer or an authorised specialist workshop.



- ▷ Further information can be obtained in the instruction manual for the respective appliance.

The heater, boiler, cooker and refrigerator are fitted depending on the model of the vehicle.

In this instruction manual a description is given only for the operation of the appliances and their particular features.

To operate gas appliances, first open the regulator tap on the gas bottle and the gas isolator tap corresponding to the appliance.

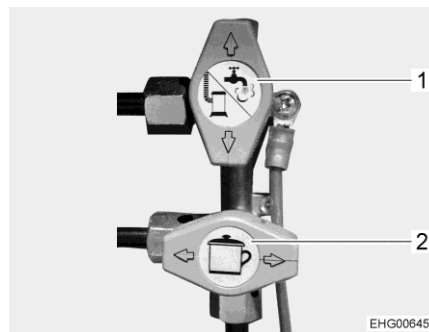

- 1 Heater / hot water gas isolator tap, closed
- 2 Cooker gas isolator tap, open

Fig. 78 Gas isolator taps position (example)

10.2 Heater / production of hot water

The heater can both heat up the vehicle interior (heating the room air) and heat up the domestic water (boiler function). The following instructions are also valid if the heater is only used as boiler.



- ▶ Never let gas escape unburned due to danger of explosion.
- ▶ Never run the heater in gas operation when refuelling, on ferries or in the garage. Danger of explosion!
- ▶ Never operate the heater in gas operation in closed spaces (e.g. garages). Danger of poisoning and suffocation!
- ▶ Do not use the space above and behind the heater as a storage space.
- ▶ The domestic water can be heated up to 65 °C. Risk of scalding!



- ▷ The circulation fan is automatically switched on when the hot-air heater is activated, and it stays on. This puts an immense strain on the living area battery, if the vehicle is not connected to an external 230 V power supply. Take into consideration that the living area battery only has limited reserves of energy.
- ▷ Never use the production of hot water without water inside it.
- ▷ When the production of hot water of the heater is not used, empty the domestic water container if there is a risk of frost.
- ▷ Only operate the production of hot water with the maximum temperature setting if you require a large quantity of warm water. This protects the appliance against the build-up of limescale.



- ▷ Do not use the water heated by the heater as drinking water.
- ▷ Operate the heater a few minutes under full load at regular intervals (at least every 3 months) to remove condensation. This prevents odours.

Initial start-up

When lighting the heater for the first time a small amount of smoke and odour will occur. Immediately set the operating switch of the heater to its highest position. Open doors and windows and ventilate well. Smoke and odour will disappear by themselves after a while.

10.2.1 To heat properly



Fig. 79 Air outlet nozzle (hot-air heater)

Hot air distribution

Several air outlet nozzles (Fig. 79) are built into the vehicle. Pipes conduct the warm air to the air outlet nozzles. Turn the air outlet nozzles in a suitable position so the air can escape as required. To avoid draft close the air outlet nozzles on the dashboard and set the air distribution of the base vehicle to air circulation.

Adjusting the air outlet nozzles

- Fully open: Full hot air stream
- Half or partially open: Reduced hot air stream

When five air outlet nozzles are completely opened, less warm air escapes through each nozzle. However, if only three air outlet nozzles are opened, more warm air flows out of each nozzle.

10.2.2 Heater and production of hot water (Truma Combi)



- ▷ If the heater is not in operation when there is a risk of frost, empty the domestic water container.

The power supply of the heating control system cannot be interrupted by means of the 12 V main switch.

The heater is operated with gas.



Fig. 80 Operating unit

- 1 Summer operation water temperature 60 °C
- 2 Summer operation water temperature 40 °C
- 3 Off
- 4 Winter operation "Only heater"
- 5 Winter operation "Heater and production of hot water"
- 6 Rotary switch (external ring)
- 7 Indicator lamp "Heater operation" (green)
- 8 Temperature control knob
- 9 Indicator lamp "Heating up period of production of hot water" (yellow)/ "Fault" (red)

Operating modes

The heater can be operated in different operating modes:

- Winter operation (with or without production of hot water)
- Summer operation (only production of hot water)

Selecting operating mode:

- Set the operating mode using the rotary switch (Fig. 80,6).

Heater with gas operation

The heater is operated exclusively with gas.

Winter operation

In winter operation "Heater and production of hot water" (Fig. 80,5) the domestic water is automatically heated up when the heater is switched on. If the heater switches off after the required room temperature has been reached, the domestic water will continue to heat up until the set water temperature has been reached.

A temperature sensor next to the panel measures the room temperature.

In the operating mode "Only heater" (Fig. 80,4) the heater can be operated with an empty domestic water container.

Switching on:

- Open the regulator tap on the gas bottle and the gas isolator tap "Heater/boiler".
- Turn the temperature control knob (Fig. 80,8) on the operating unit to the desired heating level.
- Set rotary switch (Fig. 80,6) to winter operation "Only heater" (Fig. 80,4) or to winter operation "Heater and production of hot water" (Fig. 80,5).

The green indicator lamp (Fig. 80,7) is on.

The circulation fan automatically switches on when the heater is activated.

- Switching off:*
- Turn the rotary switch (Fig. 80,6) to "O" (Fig. 80,3).
 - Close the gas isolator tap "Heater/boiler" and the regulator tap on the gas bottle.

After switching off the heater, the circulation fan may still run for a moment to use up the residual heat.

Summer operation

It is not possible to heat the vehicle in "Summer" operating mode. In this operating mode, only the domestic water is heated up to 40 °C or 60 °C.

Switching production of hot water on:

- Open the regulator tap on the gas bottle and the gas isolator tap "Heater/boiler".
- Set the rotary switch (Fig. 80,6) on the operating unit (Fig. 80) to "Summer operation" (Fig. 80,1 or 2).

The yellow indicator lamp (Fig. 80,9) is illuminated during the heating up period. When the set water temperature is reached, the period of heating up is finished and the yellow indicator lamp fades.

In case of fault, the indicator lamp (Fig. 80,9) on the operating unit glows red (see section 15.5).

Switching production of hot water off:

- Set the rotary switch (Fig. 80,6) on the operating unit (Fig. 80) to "O".
- Close the gas isolator tap "Heater/boiler" and the regulator tap on the gas bottle.

Safety/drainage valve

The heater is equipped with a safety/drainage valve (Fig. 81). The safety/drainage valve prevents water for the production of hot water from freezing, when there is frost and the heater is not switched on.



- ▷ When the vehicle is not used for a long period of time, open the safety/drainage valve and empty the heater.
- ▷ At temperatures below 2 °C the safety/drainage valve opens automatically. Only if the temperature of the safety/drainage valve lies above 6 °C can it be shut again.
- ▷ The water pump and the water fittings are not protected against freezing by the safety/drainage valve.



- ▷ The drainage neck of the safety/drainage valve has to be free of dirt (e.g. leaves, ice) at all times.

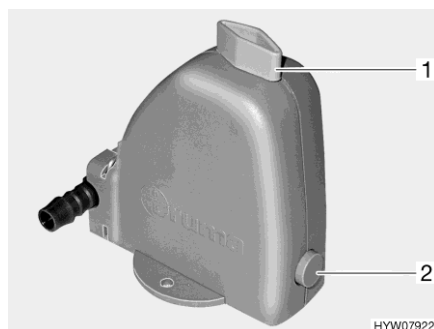

Fig. 81 Safety/drainage valve

Filling/emptying domestic water container

The domestic water container can be supplied with water from the water tank.

Filling the domestic water container with water:

- Switch on the 12 V power supply on the panel.
- Close the safety/drainage valve. Turn the knob (Fig. 81,1) perpendicular to the safety/drainage valve and push the push button (Fig. 81,2) in.
- Set all the water taps to "Hot" and open them. The water pump is turned on. The warm water pipes are filled with water.
- Keep the water taps open until the water flowing out of the water taps has no bubbles in it. This is the only way to ensure that the domestic water container is full of water.
- Close all water taps.

Emptying the domestic water container:

- Set the rotary switch (Fig. 80,6) on the operating unit (Fig. 80) to "O".
- Open the safety/drainage valve. To do this turn the knob (Fig. 81,1) parallel to the safety/drainage valve. The push button (Fig. 81,2) jumps out. The domestic water container is emptied to the outside through the safety/drainage valve.
- Check whether the water has been drained completely from the domestic water container (approx. 12 litres).



- ▷ Further information can be obtained in the manufacturer's instruction manual.

10.2.3 Diesel heater and production of hot water (Truma Combi D)

The heater and production of hot water Truma Combi D is operated with diesel.

The functions, the control unit, and the operation are the same as for the gas/current operated heater Truma Combi, see section 10.2.2.

Refer to the heater manufacturer's documentation for further information.

10.2.4 Independent vehicle heater (Webasto)



- ▶ Do not operate the heater in closed spaces. Danger of suffocation!
- ▶ Do not operate the heater at petrol stations. Danger of explosion!

The inside and the engine can be heated with the independent vehicle heater.

The heating function can be switched on and off manually or via a timer.

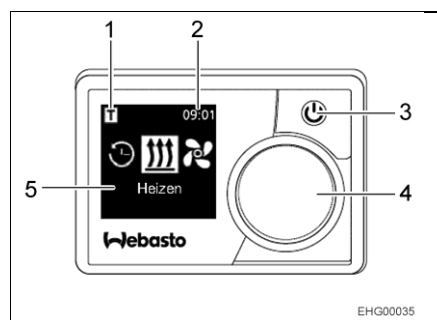

- 1 Symbol, pre-set time activated
- 2 Time
- 3 Start button with status indicator
- 4 Control button
- 5 Menu display

Fig. 82 Operating unit (independent vehicle heater)

Switching on the heater for the base vehicle:

- Set the heater control to "Warm".
- Switch on the fan.
- For continuous operation: Set the fan to the lowest fan setting (due to battery capacity).
- To quickly heat up the vehicle: Set the fan to a higher fan setting.
- Open and close the base vehicle's air outlet nozzles as desired.

Switching on the independent vehicle heater:

- Press the button (Fig. 82,3).
- Set desired function by turning the control button (Fig. 82,4).

See the manufacturer's documentation for further information.

10.2.5 Boiler (Whale)



- ▶ Make sure that the operating pressure of the gas supply for the boiler is between 28 and 30 mbar.



- ▷ Empty the boiler if there is risk of frost or when the boiler is not used for more than 3 days.

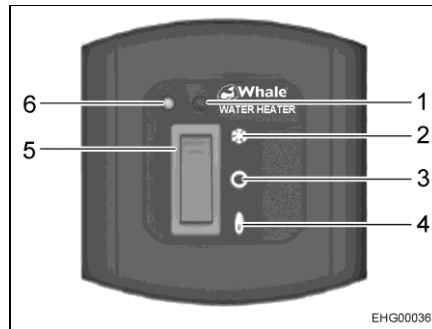

- 1 Diagnostics LED
- 2 Frost protection
- 3 Gas OFF
- 4 Gas ON
- 5 Switch
- 6 Control LED, gas flame ignited

Fig. 83 Boiler operating panel

Switching on the boiler:

- Open the regulator tap on the gas bottle and the gas isolator tap "Heater/boiler".
- Make sure that the drain cock has been closed.
- Set all the water taps to "Hot" and open them. The water pump is turned on. The water pipes are filled with water.
- Keep the water taps open until the water flowing out of the water taps has no bubbles in it. This is the only way to ensure that the boiler is full of water.
- Close all water taps.
- Set the switch (Fig. 83,5) to the position "Gas ON" (Fig. 83,4). When the flame has successfully been ignited, the control LED "Gas flame ignited" (Fig. 83,6) glows green.

Switching the boiler off:

- Set the switch (Fig. 83,5) to the position "Gas OFF" (Fig. 83,3).
- Close the gas isolator tap "Heater/boiler" and the regulator tap on the gas bottle.

Switching on frost protection:

- Set the switch (Fig. 83,5) to the position "Frost protection" (Fig. 83,2).



- ▷ Do not use the frost protection function for more than 3 days.

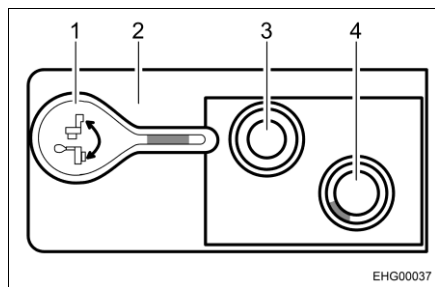

Fig. 84 Drain cock, closed

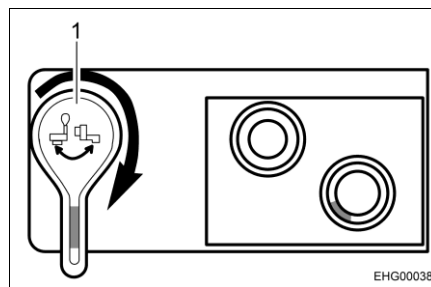

Fig. 85 Drain cock, open

- 1 Drain cock lever, closed
- 2 Boiler top
- 3 Cold water connection
- 4 Hot water connection

- 1 Drain cock lever, open

Emptying the boiler:

- Switch off the boiler.
- Open the drain cock. In order to do this, turn the lever of the drain cock through 90° in a clockwise direction (see Fig. 85,1).



- ▷ While heating, water drips from the drain pipe of the pressure relief valve. In order to protect the pressure relief valve from calcifications: actuate the pressure relief valve at least twice a year. In order to do this, turn the lever of the drain cock through 90° in an anticlockwise direction.

Observe instructions for maintenance in section 13.5.

10.2.6 Wall flue

Fresh air and exhaust gases of the heater system are conducted in a two-chamber wall flue.



- ▷ Park the vehicle such that the wall flue gets enough fresh air.
- ▷ The wall flue must be free at all times. Do not cover the wall flue.
- ▷ When camping in winter, maintain wall flue free of snow and ice.
- ▷ Check the wall flue periodically depending on the weather (snow, leaf fall, dirt, etc.). If necessary, clean the wall flue.
- ▷ When washing the vehicle do not aim the water jet directly at the wall flue.
- ▷ When disregarding this, the flawless operation of the heater can not be guaranteed.



Fig. 86 Wall flue (hot-air heater)

The wall flue is mounted on the left side wall.

10.3 Gas cooker



- ▶ During operation of the gas cooker, do not leave the gas cooker unattended. Even if the gas cooker cannot be overseen for only a short time (e.g. Visit to the toilet), switch the gas cooker off.
- ▶ Never let gas escape unburned due to danger of explosion.
- ▶ Before using the cooker make sure that there is sufficient ventilation. Open a window or the skylight.
- ▶ Do not use the gas cooker for heating purposes.
- ▶ Do not attach any curtains, drapes, nor dish towels in the immediate proximity of the cooker. Fire hazard!
- ▶ Always protect your hands with cooking gloves or potholders when handling hot pots, pans and similar items. There is a risk of injury!
- ▶ During activation and operation of the gas cooker, no flammable objects or highly inflammable objects such as dishcloths, napkins etc. must be near the gas cooker. Fire hazard!
- ▶ The process of ignition must be visible from above and must not be covered by cooking pans placed on the cooker.
- ▶ The gas cooker cover is held closed by a spring. When closing there is danger of getting injured!



- ▷ Do not use the glass gas cooker cover as a hob.
- ▷ Do not close the gas cooker cover while the gas cooker is in operation.
- ▷ Do not apply pressure on the gas cooker cover when it is closed.
- ▷ Do not place hot cooking pans either on the gas cooker or on the sink cover.
- ▷ Keep the gas cooker cover open after cooking until the burners are cool. Otherwise the glass plate could shatter.



- ▷ Only use pots and pans whose diameter is appropriate for the gas cooker burners.
- ▷ When the flame goes out, the thermocouple automatically cuts the gas supply.
- ▷ Further information can be obtained in the device manufacturer's instruction manual.

The vehicle kitchen unit is fitted with a two-burner gas cooker.

The operating controls for the gas cooker are located directly at the gas cooker.

Gas cooker

Fig. 87 Gas cooker

Switching on:

- Open the regulator tap on the gas bottle and the gas isolator tap "Cooker".
- Open the gas cooker cover.
- Turn the control knob (Fig. 87,1) on the burner you wish to use to the ignition position (large flame).
- Press the control knob down and hold it.
- Press the push button (Fig. 87,2). An ignition spark is created at the burner. If necessary, press the push button several times.
- Once the flame is burning, keep the control knob pressed for another 10 to 15 seconds, until the thermocouple automatically keeps the gas supply open.
- Release the control knob and turn to the desired setting.
- If ignition is unsuccessful, repeat the entire procedure.

Switching off:

- Turn the control knob to the "0" position. The flame fades.
- Close the gas isolator tap "Cooker" and the regulator tap on the gas bottle.

10.4 Refrigerator

During the journey, the refrigerator is only operated via the 12 V power supply. At high ambient temperatures the refrigerator is unable to reach its full cooling power.

10.4.1 Compressor refrigerator



- ▶ Always keep the ventilation openings unobstructed.
- ▶ Due to technical reasons, the temperature in the refrigerator and in the freezer compartment cannot always be maintained at a constant level. Under adverse conditions, the food in the freezer compartment may thaw.



- ▷ Do not use any objects or hot air devices to accelerate defrosting.
- ▷ When the vehicle is exposed to intense sunlight: ventilate vehicle adequately.
- ▷ Before setting off, secure the products in the refrigerator against sliding.



- ▷ The refrigerator temperature depends on the ambient temperature (room temperature), the frequency the door is opened with, and the filling of the refrigerator. If required, readjust the cooling level.
- ▷ The living area battery has a limited power supply only. When the vehicle is stationary, do not use the refrigerator for long periods without it being connected to the 230 V connection.
- ▷ Check the collection tray for condensation before setting off and periodically during operation of the refrigerator.
- ▷ Further information can be obtained in the manufacturer's instruction manual.

Operating modes

The refrigerator is only operated with 12 V DC.

The 12 V power supply is always fed via the transformer/rectifier.

When the vehicle is in motion, the transformer/rectifier feeds the power from the vehicle generator to the refrigerator.

When the vehicle is stationary and **not** connected to the 230 V power supply, the transformer/rectifier supplies the refrigerator with power from the living area battery.

When the vehicle is stationary and connected to the 230 V power supply, the transformer/rectifier transforms the input voltage to 12 V and then supplies this current to the refrigerator.

Conversion between the individual supply types is automatic.

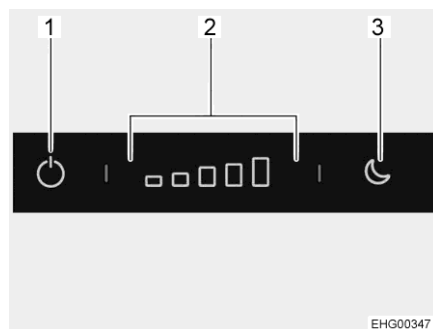

- 1 On/off button
- 2 Operating panel cooling level setting
- 3 Night mode button

Fig. 88 Operating controls (refrigerator)

Switching on: ■ Press on/off button (Fig. 88,1) and hold for approximately 2 seconds. The blue indicator lamp shows that the refrigerator is working. The operating panel (Fig. 88,2) shows the set cooling level. This display is dimmed after approximately 10 seconds.

Switching off: ■ Press on/off button (Fig. 88,1) and hold for approximately 2 seconds. The blue indicator lamp will go out slowly.

The cooling level, with which the refrigerator cools, must be selected depending on the room temperature. A high room temperature requires a higher cooling level. At a low room temperature, a lower cooling level would be enough.

Setting the cooling level: ■ On the operating panel (Fig. 88,2), press the desired cooling level.

The refrigerator has a night mode. When the night mode is switched on, the refrigerator works silently with low power.

Switching on the night mode: ■ Press the night mode button (Fig. 88,3). The blue indicator lamp shows that the night mode is active.

Switching off the night mode: ■ Press the night mode button (Fig. 88,3). The blue indicator lamp will go out. The refrigerator is working in normal mode again.

During operation, condensation may collect in the collection tray underneath the freezer compartment. The collection tray must be emptied periodically.



▷ Further information can be obtained in the manufacturer's instruction manual.

10.4.2 Refrigerator door locking mechanism



- ▷ During the journey the refrigerator door must always be closed and locked in the closed position.



- ▷ Lock the refrigerator door in ventilation position when the refrigerator is switched off. This prevents mould forming.

There are two positions for locking the refrigerator door in place:

- Closed refrigerator door during travel and when the refrigerator is in operation
- Slightly opened refrigerator door as a ventilation position when the refrigerator is switched off

Thetford The refrigerator is opened and closed with the handle on the door.

Opening: ■ Press the handle to the side, keep it pressed and open the refrigerator door.

Closing: ■ Close the refrigerator door. The lock hook engages audibly.

Ventilation position The refrigerator door may be locked in ventilation position with a swivelling bracket.

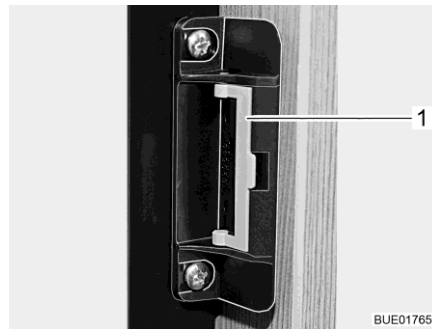

Fig. 89 Locking device in normal position



Fig. 90 Locking device in ventilation position

- Locking:*
- Open the refrigerator door.
 - Swing the bracket (Fig. 89,1) to the front (Fig. 90).

If the refrigerator door is closed now, a gap will remain towards the refrigerator.

Chapter overview

This chapter contains instructions regarding the sanitary fittings of the vehicle.

11.1 Water supply, general



- ▶ Fill water tank from supply systems that have been verified to provide drinking water quality.
- ▶ Only use such hoses or containers when filling that have been approved for use with drinking water.
- ▶ Thoroughly rinse filling hose or container with drinking water before use (2 to 3 times capacity).
- ▶ Empty filling hose or container completely after use and close openings of the filling hose or container.
- ▶ Water left standing in the water tank or in the water pipes becomes undrinkable after a short period. Therefore, before each use of the vehicle, thoroughly clean the water pipes and the water tank. After each use of the vehicle completely empty the water tank and the water pipes.
- ▶ In the case of lay-ups lasting more than a week disinfect the water system before using the vehicle (see chapter 12).



- ▷ If the vehicle is not used for several days or if it is not heated when there is a risk of frost, empty the entire water system. Make certain that the water pump is switched off. Otherwise, the water pump will overheat and may get damaged. Leave the water taps on in central position. Leave all drain cocks open. Frost damage to appliances, frost damage to the vehicle and deposits in water-carrying components can be avoided in this way.
- ▷ The water pump will overheat without water and can get damaged after one minute at the latest. Never operate water pump when the water tank is empty.

The vehicle is equipped with a fitted water tank. An electric water pump pumps the water to the individual water taps. Opening a water tap automatically switches on the water pump and pumps water to the tap.

The waste water tank collects the waste water. The water level in the water and waste water tanks can be checked on the panel.



- ▷ Before using the water fittings, the 12 V power supply on the panel must be switched on. Otherwise the water pump will not work.

Position of the water pump

The submerged pump is located in the water tank.

11.2 Water tank

The water tank holds approx. 90 l.



- ▷ For driving safety and for regulatory reasons, when the vehicle is motion the fill quantity must be reduced. If the water is drained using the safety drainage rotary handle (see section 11.2.4), a residual quantity of approximately 20 litres will remain in the water tank.

Position The water tank is installed on the right side in the rear area and accessible via 2 flaps.



Fig. 91 Water tank

11.2.1 Drinking water filler neck with cap

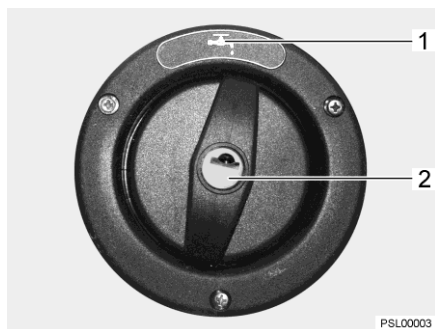

Fig. 92 Cap for the drinking water filler neck

The drinking water filler neck is on the right or left side of the vehicle, depending on the model.

The drinking water filler neck is indicated by the symbol "☞" (Fig. 92,1). The cap is opened and closed using the key for the external flap locks.

- Opening:**
- Insert key into locking cylinder (Fig. 92,2) and turn a quarter turn in an anticlockwise direction.
 - Remove the cap.
 - Fill the water tank with drinking water.
- Closing:**
- Place cap on the drinking water filler neck.
 - Turn key one quarter turn in a clockwise direction.
 - Remove the key.
 - Check that the cap sits firmly on the drinking water filler neck.

11.2.2 Filling the water system



- ▶ When filling the water tank, observe the maximum permissible gross weight of the vehicle. Luggage must be reduced accordingly when the water tank is full.



- ▷ The water pump will overheat without water and can get damaged after one minute at the latest. Never operate water pump when the water tank is empty.



- ▷ The water quantity can be monitored on the panel while the water tank is filled.

- Position the vehicle horizontally.
- Switch on the 12 V power supply on the panel.

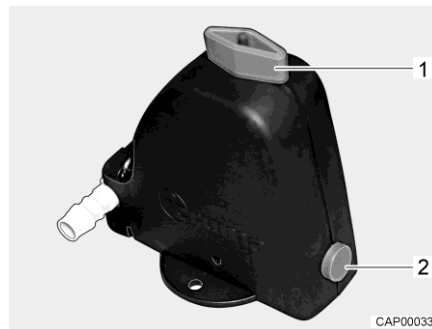

Fig. 93 Safety/drainage valve open

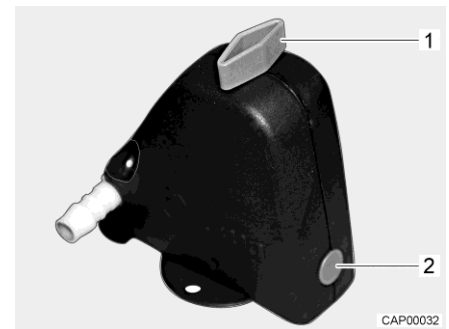

Fig. 94 Safety/drainage valve closed

- Close the safety/drainage valve. Turn the knob (Fig. 93,1) perpendicular to the safety/drainage valve and push the push button (Fig. 93,2) in. The closed safety/drainage valve is shown in Fig. 94. If the temperature is below 6 °C, the safety/drainage valve cannot be closed.
- Close all water taps.
- Close the drainage opening of the water tank.
- Open the drinking water filler neck on the outside of the vehicle.
- Fill the water tank with drinking water. Use a water hose, a water canister with a funnel or similar for filling.
- Set all the water taps to "Hot" and open them. The water pump is turned on. The warm water pipes are filled with water.
- Keep the water taps open until the water flowing out of the water taps has no bubbles in it. This is the only way to ensure that the boiler is full of water.
- Set all water taps to "Cold" and leave them open. This will fill the cold water pipes with water.
- Keep the water taps open until the water flowing out of the water taps has no bubbles in it.
- Close all water taps.
- Close drinking water filler neck.
- Check that the cap on the water tank is not leaking.

11.2.3 Topping up the water



- ▶ When filling the water tank, observe the maximum permissible gross weight of the vehicle. Luggage must be reduced accordingly when the water tank is full.

To fill the water tank with drinking water, proceed as follows:

- Open drinking water filler neck (Fig. 92).
- Fill the water tank with drinking water. Use a water hose, a water canister with a funnel or similar for filling.
- Close drinking water filler neck.

11.2.4 Reducing the water quantity for mobile operation



- ▶ When filling the water tank, observe the maximum permissible gross weight of the vehicle. Luggage must be reduced accordingly when the water tank is full.

Rotary handle

The rotary handle is installed on the water tank.

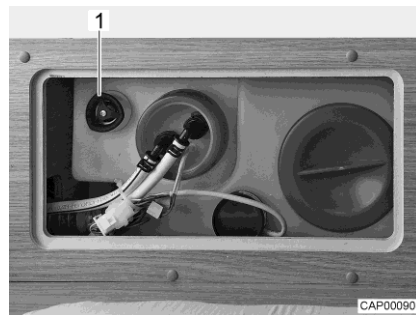

Fig. 95 Water tank with rotary handle

- Closing:*
- Turn the rotary handle (Fig. 95,1) on the water tank in a clockwise direction as far as it will go.
 - Fill the water tank with drinking water.
- Opening:*
- Turn the rotary handle (Fig. 95,1) on the water tank in an anticlockwise direction as far as it will go. Excess water will drain away leaving approx. 20 litres in the tank.

11.2.5 Draining water

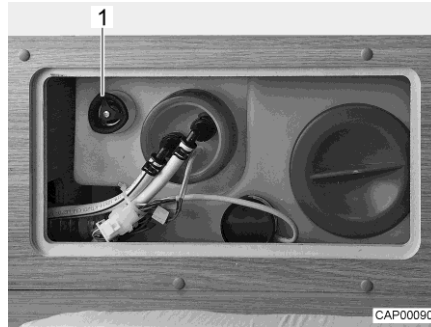

Fig. 96 Water tank with rotary handle

- Turn the rotary handle (Fig. 96,1) on the water tank in an anticlockwise direction as far as possible beyond the resistance to fully open the drainage opening.

11.2.6 Emptying the water system



- ▷ If the vehicle is not used for several days or if it is not heated when there is a risk of frost, empty the entire water system. Make sure that the 12 V power supply on the panel is switched off. Otherwise, the water pump will overheat and may get damaged. Leave the water taps on in central position. Leave the safety/drainage valve (if there is one) and all drain cocks open. Frost damage to appliances, frost damage to the vehicle and deposits in water-carrying components can be avoided in this way.

To empty and ventilate the water system, proceed as follows. This prevents frost damage and deposits:

- Position the vehicle horizontally.
- Switch off 230 V power supply. In order to do this, switch off the 230 V fuse (see section 9.7.2). The external 230 V connection can remain connected to charge the batteries.
- Switch off the 12 V power supply on the panel.
- Shut off the production of hot water (see section 10.2.2).

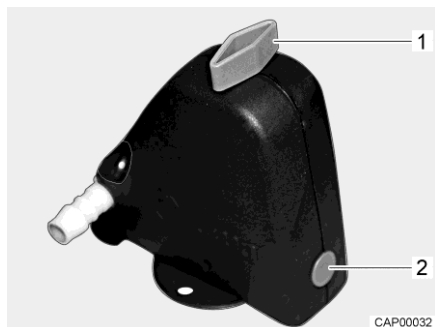

Fig. 97 Safety/drainage valve closed

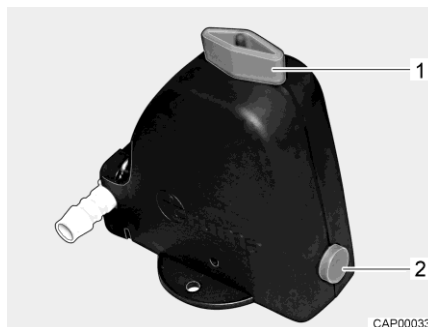

Fig. 98 Safety/drainage valve open

- Open the safety/drainage valve (Fig. 97). To do this, turn the knob (Fig. 97,1) parallel to the safety/drainage valve. The push button (Fig. 97,2) jumps out. The open safety/drainage valve is shown in Fig. 98.
- Open the water tank drain (see section 11.2.5).
- Open all water taps and set to the central position.
- Hang the shower handset up in the shower position.
- Hold the water pump up until the water pipes are completely empty.
- Check whether the water tank is completely empty.
- Blow out the remaining water in the water pipes (max. 0.5 bar). To do this, remove the pipe from the water pump and blow into the pipe.
- Clean the water tank and then rinse it out thoroughly.
- Let the water system dry for as long as possible.
- After emptying, leave all water taps on in the central position.
- Keep the safety/drainage valve open.

11.3 Waste water tank



- ▷ In case of frost add so much anti-freeze (such as kitchen salt) to the waste water tank so that the waste water cannot freeze.
- ▷ Never pour boiling water directly into the sink outlet. Boiling water could cause deformation and leaks in the waste water pipe system.



- ▷ Only empty the waste water tank at disposal stations, camping sites or caravan sites especially provided for this purpose.

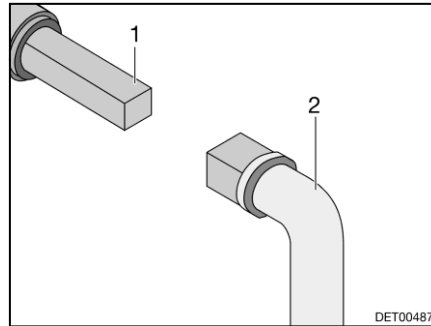

Fig. 99 Operation of the waste water tap

The waste water tap for the waste water disposal is installed on the left-hand side of the vehicle.

The square bolt for opening the waste water tap is directly accessible under the vehicle floor.

- Emptying:*
- Place key (Fig. 99,2) onto the square bolt (Fig. 99,1).
 - In order to open the waste water tap, turn the square bolt a quarter turn.
 - Completely empty waste water tank.
 - To close the waste water tap, turn the square bolt back as far as it will go.

11.4 Insulated and heated waste water tank

Depending on the model and the equipment, the vehicle will have been equipped with an insulated and heated waste water tank, as well as with an automatic control of the waste water tank heater.

If the On/Off switch of the control has been switched on (Fig. 100), the waste water tank heater switches on automatically as soon as the external temperature drops below 0 °C. This protects the waste water tank from frost.

Position of switch

The On/Off switch is located underneath the kitchen worktop.



Fig. 100 On/Off switch, switched on

Switching on the automatic waste water tank heater:

- Press lower part of the On/Off switch. The LED indicator (Fig. 100,1) is lit.

Switching off on the automatic waste water tank heater:

- Press upper part of the On/Off switch. The LED indicator (Fig. 100,1) goes out.

11.5 Toilet compartment



- ▷ Do not transport any loads in the shower tray. The shower tray or other items of equipment in the toilet compartment can be damaged.

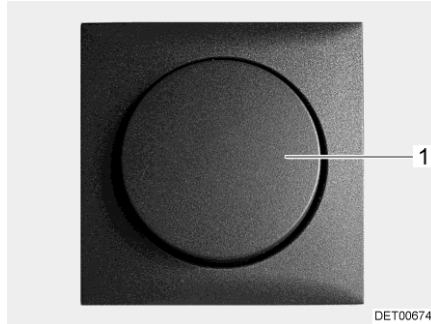

Fig. 101 Light switch for toilet compartment

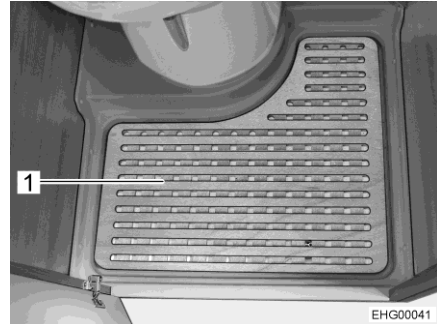

Fig. 102 Removable floor plate

The light switch (Fig. 101,1) for the toilet compartment is located in the toilet compartment.

- Take out the removable floor plate (Fig. 102,1) for showering.

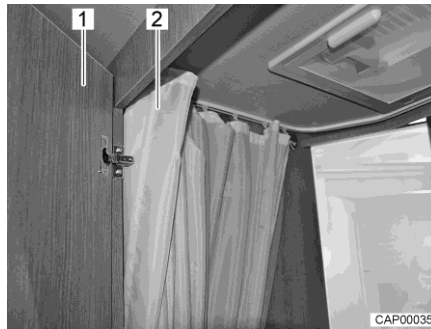

Fig. 103 Toilet compartment with shower

- For showering, close the door (Fig. 103,1) and completely close the shower curtain (Fig. 103,2) so that all walls are protected.
- Pull shower handset out and hook it into the opening provided for this purpose on the shower curtain.
- For ventilation purposes during or after a shower, and for drying wet clothing, close the toilet compartment door and open the window or the toilet compartment skylight. This improves the air circulation.
- After taking a shower, rinse soap residue from the shower tray, otherwise cracks can appear in the shower tray over time.
- After using the shower, wipe it dry to prevent moisture from collecting.



- ▷ Further information about cleaning the toilet compartment can be found in the section 12.2.

11.6 Toilet



- ▷ Do not load the toilet with more than a maximum of 120 kg.
- ▷ If there is any risk of frost and the vehicle is not heated, empty the sewage tank.
- ▷ Do not sit on the lid of the toilet. The lid is not designed to bear the weight of a person and could break.
- ▷ Use a suitable chemical for this toilet. The ventilation will merely remove the odour but not germs and gases. Germs and gases will have a detrimental effect on the sealing rubbers.



- ▷ Further information can be obtained in the manufacturer's instruction manual.



- ▷ Only empty the sewage tank at disposal stations, at camping sites or caravan sites, that are especially provided for this purpose.

11.6.1 Swivel toilet

The flushing of the toilet is fed directly from the water system of the vehicle.

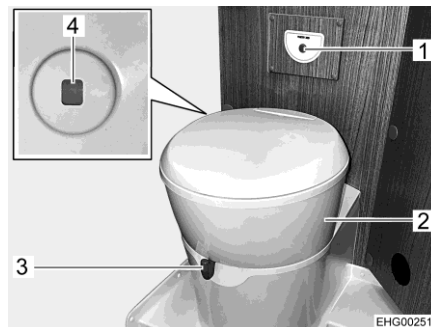

Fig. 104 Toilet

The toilet bowl can be rotated into the required position. In order to do this, grab the toilet's upper part (Fig. 104,2) with both hands and rotate it.

The operating unit with the flush button (Fig. 104,1) is installed near to the toilet bowl.

The colour of the level indicator (Fig. 104,4) changes from green to red whenever the sewage tank has to be emptied.

- Flushing:*
- Before flushing open the sliding trap of the toilet. To do this, push the slide lever (Fig. 104,3) in an anticlockwise direction.
 - For flushing, press the blue flush button (Fig. 104,1).
 - After flushing close the sliding trap. To do this, push the slide lever in a clockwise direction.

11.6.2 Emptying the sewage tank



- ▷ The sewage tank can only be taken out if the sliding trap is closed.



Fig. 105 Flap for the sewage tank



Fig. 106 Sewage tank

- Slide the slide lever on the toilet bowl in a clockwise direction. The sliding trap is closed.
- Open the flap for the sewage tank on the outside of the vehicle. Insert the key into the locking cylinder (Fig. 105,1) of the push-button lock and turn a quarter turn in a clockwise direction.
- Remove the key.
- Press both push-button locks (Fig. 105,2) simultaneously with your thumb and open the flap for the sewage tank.
- Swivel flap fully upwards and carefully set on the exterior wall. The flap is kept open magnetically.
- Pull the retaining clip (Fig. 106,2) upwards and pull out the sewage tank (Fig. 106,1).
- Completely empty the sewage tank at disposal stations that are especially provided for this purpose.



- ▷ Actuate the aeration knob on the sewage tank with your thumb to empty it completely.

11.6.3 Winter operation



- ▷ Do not use anti-freeze. Anti-freeze can damage the toilet.

If the toilet, the water tank and the sewage tank (cassette) are in a frost-protected part of the vehicle, the toilet can also be used in the winter.

If the toilet, the water tank and the sewage tank (cassette) are not in a frost-protected part of the vehicle, empty the water tank, the sewage tank and the water pipes if there is a risk of frost. This prevents frost damage.

11.6.4 Temporary lay-up



- ▷ If the toilet is not to be used for an extended period, empty the water tank, the sewage tank and the water pipes.

Laying up the toilet:

- Empty the water tank.
- Flush the toilet until no more water runs into the toilet. Note that the pump can get damaged after one minute at the latest if it runs dry.
- Empty the sewage tank.
- Rinse the sewage tank thoroughly.
- Leave the drainage neck on the sewage tank open.
- Let the sewage tank dry for as long as possible.

Chapter overview

This chapter contains instructions regarding the care of the vehicle.

At the end of the chapter there is a checklist of measures you must carry out if you are not going to use the vehicle for an extended period of time.

12.1 External care

12.1.1 General

Standard external care consists of regular washing. The use and the environmental conditions will determine how often the vehicle needs to be washed. Wash the vehicle more frequently in areas which are exposed to heavy air pollution or heavy traffic or roads treated with de-icing salts. If the vehicle is exposed to salty and humid air (coastal areas, humid climates), wash the vehicle more frequently.

Do not park under trees if at all possible. The resin-like discharge which many trees secrete, give the paintwork a matt look and can promote the onset of corrosion.

Wash off bird droppings straight away and thoroughly, as the acid it contains is extremely corrosive.

12.1.2 Washing with a high-pressure cleaner



- ▷ Do not clean the tyres with a high-pressure cleaner. The tyres might be damaged.
- ▷ Do not spray external applications (deco-films) directly with the high-pressure cleaner. The external applications could come off.

Before cleaning the vehicle with a high-pressure cleaner, observe the operating manual of the high-pressure cleaner.

When cleaning with the nozzle for circular jet between the vehicle and the cleaning nozzle, maintain a minimum distance of approx. 700 mm.

Take into consideration that the jet of water comes out of the cleaning nozzle with pressure. The vehicle may be damaged by incorrect handling of the high-pressure cleaner. The temperature of the water should not be above 60 °C. Keep the jet of water in constant movement during the washing process. Do not direct the water jet at clearances, built-in electrical parts, plugs, seals, the ventilation grill or the skylights. The vehicle may be damaged or water may enter the interior.

12.1.3 Washing the vehicle



- ▷ Never clean the vehicle in the car wash. The brush rollers can damage the external applications. Water can enter the waste gas vents or the forced ventilations. The vehicle could be damaged.
- Wash the vehicle only on a washing site intended for this purpose.
- Avoid full sunshine. Observe environmental measures.
- Only clean external applications and synthetic parts with plenty of warm water, dish washing liquid and soft cloth.
- Wash down the vehicle with plenty of water, a clean sponge or a soft brush. In the case of stubborn dirt add dish washing liquid to the water.
- Painted exterior walls may also be cleaned with a caravan cleaner.
- Add-on parts made of glass-fibre reinforced plastic (GRP) require a regular follow-up treatment with a polisher. This way these parts will not turn yellow and the sealing of the surface remains intact.
- Treat rubber seals on doors and storage flaps with a conventional rubber care product.
- Treat locking cylinder of doors and storage flaps with graphite dust.

12.1.4 Windows of acrylic glass

Acrylic glass windows are delicate and require very careful handling.



- ▷ Never rub acrylic glass windows dry as dust particles might damage the surface.
- ▷ Only clean acrylic glass windows with plenty of warm water, some dish washing liquid and a soft cloth.
- ▷ Never use glass cleaning agents with chemical, abrasive or alcohol-containing additives. Premature brittleness of the panes and associated cracks may result from their use.
- ▷ Avoid contact of cleansing agents used for the body (e.g. tar- or silicone-removing agents) with acrylic glass.
- ▷ Do not clean vehicle in car wash.
- ▷ Do not attach stickers to the acrylic glass windows.
- ▷ Having cleaned the vehicle rinse acrylic glass with sufficient clear water.
- ▷ Treat rubber seals with a conventional rubber care product.



- ▷ An acrylic glass cleanser with antistatic effect is suitable for a follow-up treatment. Small scratches can be treated with an acrylic glass polish. These agents are available at the accessories shop.

12.1.5 Underbody

The underbody of the vehicle is partly coated with an age-resistant underbody protection. Should the underbody protection be damaged, repair immediately. Do not treat areas coated with underbody protection with spray oil.



- ▷ Only use products approved by the manufacturer. Our authorised dealers and service centres will be happy to advise you.

12.1.6 Cleaning the entrance step



- ▷ The entrance step may only be moved by hand when the drive rods have been released.

If necessary, the entrance step can be removed completely for cleaning.

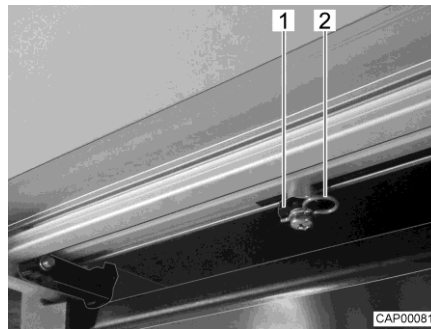

Fig. 107 Drive rod (entrance step)



Fig. 108 End stop (entrance step)

- Fully extend the entrance step.
- On the transformer/rectifier, switch off the battery cut-off switch.
- On the bottom of the entrance step, pull off both locking clips (Fig. 107,2) on the drive rods (Fig. 107,1).
- Release both drive rods from the retaining bolts.
- Unscrew one screw (Fig. 108,1) on each side of the entrance step. Such, the end stop of the entrance step is separated.
- Pull entrance step outwards by hand, out of the guide.
- Dust entrance step off with a dry brush or suck dust away with a vacuum cleaner. Do not use any water nor a high-pressure cleaner.
- Install the entrance step again by proceeding conveniently in reverse order.

12.1.7 Cleaning the elevating roof



- ▷ Do not store dirty, wet bellows folded or collapsed for a longer period of time.
- ▷ Do not use a high-pressure cleaner.
- ▷ Do not use any aggressive cleaning agents.
- ▷ Use silicone-free impregnating agents for re-impregnation, following the manufacturer's instructions for use.



- ▷ Although the canvas of the bellows is water-repellent, this does not mean that it is waterproof.
 - Elevate the elevating roof for cleaning and re-impregnation.
 - Clean elevating roof periodically with a soft brush. When doing so, the elevating roof should be dry.
 - Carefully remove small stains with an eraser or rinse with warm water (max. 35 °C).
 - Remove larger soiling with a mild soap solution (e.g. soft soap, max. 35 °C). Rinse well so that no soap residue remains.
 - Allow canvas to dry well after cleaning, preferably in the sun.
 - Re-impregnate the elevating roof if necessary.

12.2 Interior care



- ▷ If possible, treat stains immediately.
- ▷ Acrylic glass windows are delicate and require very careful handling (see section 12.1.4).
- ▷ Synthetic parts in the toilet and living area are very delicate and should be treated with care. Do not use solvents, alcohol-containing cleansers or scourers. This procedure will help you to avoid brittleness and formation of cracks.
- ▷ Hair colourants, nail varnish, cigarette ash and similar substances may cause permanent stains or discolouration. For this reason, you should prevent these substances from getting onto plastic parts. If they do get onto plastic parts, you should remove these substances immediately.
- ▷ Do not pour any corrosive agents into the drain holes. Never pour boiling water directly into the drain holes. Corrosive agents and boiling water cause damage to drainage pipes and siphon traps.
- ▷ Do not use vinegar based products to clean the toilet and water system, or for descaling the water system. Vinegar-based products may cause damage to seals or parts of the installation. Use standard descaling products for descaling.
- ▷ Save water. Mop up all remaining water.
- ▷ Vacuum off carpets and cushions with a suitable brush attachment.



- ▷ For information about the use of maintenance products, our representatives and service centres will be glad to advise.

- Surface and knobs of furniture, lamps and synthetic parts in the toilet and living area should be cleaned with water and a wool cloth. A mild cleanser may be added to the water. If required, use furniture polish for the painted surfaces.
- Clean upholstery with dry foam specially manufactured for the use on upholstery or with the foam of a mild detergent. Protect cushions from direct sunlight so that they do not lose their colour.
- Curtains and net curtains should be dry cleaned.
- Vacuum clean the carpet, if necessary clean with carpet shampoo.
- Clean PVC-floor covering with a mild, soapy cleaning agent for PVC floors. Do not place carpet on wet PVC-floor covering. The carpet and the PVC-floor covering may stick together.
- Never clean the sink or the gas cooker with a scourer. Avoid anything which may cause scratching or grooves.
- Clean gas cooker only with a moist cloth. Prevent any water from penetrating the gas cooker. Water may damage the gas cooker.
- Insect screen fabric on the door, windows, and skylights: Always remove insect residues or dirt immediately. Otherwise the fabric could be damaged. Wasps and birds could cause damages when feeding on the adhered residues. A microfibre cloth is recommended for the cleaning of the insect screen fabric. Only use cleaning agents if they are pH neutral and do not contain any solvents. If required, you can carry out a careful previous cleaning using a soft brush or a fine brush attachment on a vacuum cleaner.
- Brush blinds with a soft brush or vacuum with the brush attachment of the vacuum cleaner. Grease or stubborn dirt may be removed with a mild soap at 30 °C (curd soap).
- Brush Roman shades with a soft brush or vacuum with the brush attachment of the vacuum cleaner. Grease or stubborn dirt may be removed with a mild soap at 30 °C (curd soap).
- Unrolled seat belts can be cleaned with warm soapsuds. The seat belt must be completely dry before being rolled up.

12.2.1 Refrigerator

- Clean the exterior and interior of the refrigerator with a soft cloth and lukewarm water (containing a mild cleaning agent).
- Then, wash the refrigerator out with clear water and let it dry.
- Keep the defrosted water drain channel free of sediments.
- To prevent material changes, do not use any soap, nor any sharp, granular or soda containing cleaning agents.
- Keep oil and grease away from the door seal.

12.3 Stainless steel surfaces



- ▷ Do not clean the stainless steel surfaces with bleaching agents, with products that contain chloride or hydrochloric acid, baking powder nor with silver polish.
- ▷ Do not use scouring agent nor coarse sponges.



- ▷ Prior to cleaning, test the suitability of the cleaning product for the surface on an unobtrusive spot.
- ▷ Dry the surfaces thoroughly after cleaning to prevent scale deposits.
- ▷ In the case of brushed stainless steel surfaces, wipe in a direction of the grinding.

Removing scratches from the surface:

- Treat the stainless steel surface with a soft cleaning cloth and with a special stainless steel cleaner.
- Rinse the stainless steel surface and dry it with household wipes.

Removing stubborn dirt and burnt-in fat:

- Clean the stainless steel surface with an ordinary household sponge and with cleanser.
- Rinse the stainless steel surface and dry it with household wipes.

Removing fingerprints:

- Clean the stainless steel surface with a soft cleaning cloth and soapy water or a glass cleaning agent.
- Rinse the stainless steel surface and dry it with household wipes.

Removing coffee or tea stains:

- Treat the stainless steel surface with a baking soda solution. Allow the baking soda solution to work in for 15 minutes.
- Rinse the stainless steel surface and dry it with household wipes.

Removing rust stains:

- Clean the stainless steel surface with an ordinary household sponge and with cleanser. If necessary, use a soft cleaning cloth and stainless steel cleaner.
- Rinse the stainless steel surface and dry it with household wipes.

12.4 Water system

12.4.1 Cleaning the water tank

- Empty the water tank and close the drainage opening.
- Remove the cap of the water tank.
- Fill water tank with water and some washing-up liquid (do not use any scourers).
- Using a trade standard brush for washing dishes, scrub the water tank until there is no longer any visible deposit.
- Scrub also the pump housing.
- If possible, clean fresh water sensors through the cleaning openings by hand.
- Rinse water tank with copious amounts of drinking water.



- ▷ If, due to the design of the water tank, it is not possible to clean the water tank mechanically: Use a suitable chemical cleaning agent.

The authorised dealers would be happy to assist you in choosing a suitable cleaning agent.

Follow the cleaning agent manufacturer's instructions.

12.4.2 Cleaning the water pipes



- ▷ Only use approved cleaning agents as sold by the specialist trade.
- ▷ The cleaning agent must meet national regulations and be approved (if required).



- ▷ Collect any emerging mixture of water and cleaning agent for correct disposal.

- Empty the water system.
- Close all drainage openings and drain cocks.
- Fill mixture of water and cleaning agent into the water canister or water tank.
Observe the manufacturer's instructions regarding the mixing ratio.
- Open the drain cocks one by one.
- Leave the drain cocks open until the mixture of water and cleaning agent has reached the respective drain.
- Close the drain cocks.
- Set all the water taps to "Hot" and open them.
- Leave the water taps open until the mixture of water and cleaning agent has reached the drain.
- Set all water taps to "Cold" and open them.
- Leave the water taps open until the mixture of water and cleaning agent has reached the drain.
- Close all water taps.
- Flush the toilet several times.

- Allow the cleaning agent to act in accordance with the manufacturer's instructions.
- Empty the water system. Collect the mixture of water and cleaning agent for correct disposal.
- For rinsing fill the entire water system with drinking water and empty again several times over.

12.4.3 Disinfecting the water system



- ▷ Only use approved disinfectants as sold by the specialist trade. Observe the tolerance of humans and animals.
- ▷ The disinfectant must meet national regulations and be approved (if required).



- ▷ Collect any emerging mixture of water and disinfectant for correct disposal.

When disinfecting the water system, proceed the same way as when cleaning the water pipes (see section 12.4.2). Simply use disinfectant instead of cleaning agent.

12.4.4 Cleaning the waste water tank

Clean the waste water tank after every use.

- Empty the waste water tank.
- Open the cleaning opening on the waste water tank and the drain cock.
- Thoroughly rinse out the waste water tank with fresh water.
- If possible, clean waste water sensors through the cleaning opening by hand.

12.5 Care for vehicle operation in winter

De-icing salt damages the underbody and the parts open to water spray. We recommend that you wash the vehicle more frequently during wintertime. Mechanical and surface treated parts and the underside are under particular strain, and should therefore be cleaned thoroughly.



- ▷ If there is any risk of frost, always run heater at a minimum of 15 °C. Switch the circulation fan (if there is one) to automatic. In the case of extreme external temperatures, the furniture flaps and doors should be left slightly open. The inflowing warm air can help prevent the freezing of water pipes, for example, and counteract the formation of condensation in the storage spaces.
- ▷ If there is a risk of frost, additionally cover the windows on the outside of the vehicle overnight with winter insulation mats.

12.5.1 Preparations

- Check the vehicle for paint and rust damage. Repair damage as necessary.
- Use a wax-based rust inhibitor to protect the metal parts of the underbody.
- Use appropriate protection for external painted surfaces.

12.5.2 Winter operation

During winter operation, condensation develops when the vehicle is occupied under low-temperature conditions. To ensure good interior air quality and avoid vehicle damage from condensation, sufficient ventilation is essential.

- When heating the vehicle, the heater should be at the highest setting and roof storage cabinets, curtains and blinds should be opened. This ensures optimal ventilation.
- In the morning, lift up all cushions, air out storage boxes and dry any damp areas.



- ▷ If condensation has still developed, just wipe it off.

12.5.3 At the end of the winter season

- Thoroughly clean the underbody of the vehicle and the engine. When this is done, corrosion-inducing anti-freeze agents (salts, alkaline residues) are removed.
- Clean the exterior and use regular car wax to protect metal surfaces.

12.6 Lay-up

12.6.1 Temporary lay-up



- ▶ If the vehicle has been stationary for a long period (approx. 10 months) have the braking and gas systems checked by an authorised specialist workshop.
- ▶ Take into consideration that water is undrinkable after only a short time.
- ▶ Animal damage to cables can lead to short circuits. Fire hazard!



Animals (especially mice) can cause great damage to the interior of the vehicle. This is especially true if the animal remains undisturbed in a parked vehicle.

The animals can get into the vehicle at an opportune moment and hide from view.

To keep damages from animals to a minimum or to avoid them altogether, regularly check the vehicle for damage or animal traces. This is especially important approx. 24 hours after parking the car in storage.

If animal traces are found, contact the authorised dealer or service centre. If damage to cables has occurred, they can result in short circuits. The vehicle could catch fire.

Before laying up the vehicle, go through the following checklist:

	Activity	Done
Base vehicle	Completely fill fuel tank. This prevents corrosion damage within the fuel tank system	
	Jack up vehicle so that the wheels do not bear any load, or move vehicle every 4 weeks. This prevents any pressure points from occurring on tyres and wheel bearings	
	Protect the tyres from direct exposure to the sun. Danger of formation of cracks!	
	Inflate tyres up to the recommended maximum pressure	
	Always provide for sufficient ventilation in the underbody area  ▷ Humidity or lack of oxygen e.g. by covering with plastic film may cause optical irregularities to the underbody	
	In addition observe the notes in the operating manual of the base vehicle	
Body	All vents should be sealed with the appropriate caps and all other openings (apart from forced ventilations) should also be sealed. This prevents animals (e.g. mice) from gaining entry	
	Air the interior, all storage spaces accessible from the outside, and the parking space (e.g. garage) every 3 weeks in order to prevent the occurrence of condensation and resulting mould formation	
Interior	Place upholstery in an upright position for ventilation, and cover	
	Clean refrigerator	
	Allow refrigerator and freezer compartment doors to remain slightly open	
	Search for traces of animals that have gained entry	
	Disconnect the flat screen from the mains and, if necessary, remove it from the vehicle	
Gas system	Close regulator tap on the gas bottle	
	Close all gas isolator taps	
	Always remove gas bottles from the gas bottle compartment, even if they are empty	
Electrical system	Fully charge living area and starter battery  ▷ Charge the battery for at least 20 hours before laying up.	
	Disconnect the living area battery from the 12 V power supply. To do this, switch off the battery cut-off switch on the transformer/rectifier (see chapter 9)	
Water system	Empty the entire water system. Blow out the residual water from the water pipes (0.5 bar max.). Leave the water taps on in central position. Leave all drain cocks open. Observe the notes in chapter 11.	

12.6.2 Winter lay-up

Additional measures are required if laying up the vehicle over winter:

	Activity	Done
Base vehicle	Clean body and underbody thoroughly and spray with hot wax or protect with varnish	
	Fill fuel tank with winter diesel	
	Check antifreeze in the cooling water	
	Rectify damage to the paintwork	
	Fill in windscreen washer fluid with frost protection	
Body	Clean vehicle from outside thoroughly	
	Keep the forced ventilation open	
	Clean and grease installed supports	
	Clean and grease all door and flap hinges	
	Brush oil or glycerine on all locking mechanisms	
	Treat all rubber seals with a conventional rubber care product	
	Use graphite dust to treat locking cylinders	
Interior	Set up the de-humidifier (granulate)	
	Remove cushions and mattresses from the vehicle and store them in a dry place	
	Air the interior every 3 weeks	
	Empty all cabinets and storage compartments, open flaps, doors and drawers	
	Thoroughly clean the interior	
	If there is a risk of frost, do not leave the flat screen in the vehicle	
Electrical system	Remove the starter battery and the living area battery and store them in a place protected from frost (see chapter 9) or connect the vehicle to a 230 V supply. Before removing, remove the fuses on the living area battery	
Water system	Clean the water system using approved cleaning agents from a specialised store	
Complete vehicle	Arrange the tarpaulins in such a way that the ventilation openings are not covered, or use porous tarpaulins	

12.6.3 Starting up the vehicle after a temporary lay-up or after lay-up over winter

Go through the following checklist before start-up:

	Activity	Done
Base vehicle	Check the tyre pressure on all tyres	
	Check the tyre pressure of the spare wheel (if present)	
Body	Check the function of the entrance step	
	Check that the doors, windows and skylights are working properly	
	Check the function of all external locks	
	Remove the cover from the waste gas vent of the heater (if there is one)	
Gas system	Put the gas bottles in the gas bottle compartment, tie down and connect to the gas pressure regulator	
Electrical system	Connect to 230 V external power supply	
	Install the living area battery and starter battery, insert the fuses on the living area battery and fully charge the battery	
	 ▷ Charge the battery for at least 20 hours after lay-up.	
	Connect the living area battery with the 12 V power supply. To do this, switch on the battery cut-off switch on the transformer/rectifier (see chapter 9)	
	Check that the electrical system are working, e.g. interior light, socket and all installed electrical appliances	
Water system	Disinfect water pipes and water tank	
	Check the functionality of the operating lever for the waste water tank	
	Close all drain cocks and water taps	
	Check water system for leaks	
Appliances	Check the function of the appliances	

Chapter overview

This chapter contains instructions about official inspections and inspection and maintenance work in the vehicle.

At the end of the chapter you will find important instructions on how to obtain spare parts.

13.1 Official inspections

Depending on the national legislative provisions, the following official inspections must be carried out periodically:

- Main inspection
- Emissions test
- Inspection of the gas system

The inspection intervals in accordance with the national legislative provisions must be adhered to. The inspection stickers attached to the vehicle indicate when the next inspection is required.

For Germany, for example, the following regulation applies:

From April 1st 2022, the inspection obligation for the gas system as part of the main inspection (HU) will no longer apply. Instead, an independent gas inspection (according to DVGW (German Technical and Scientific Association for Gas and Water) worksheet G 607) must be carried out for recreational vehicles (motorhomes and caravans). The gas inspection is evidenced by the correctly completed yellow inspection book and a valid inspection sticker on the vehicle.

For more information on the gas inspection and the intervals at which it must be carried out, see the following websites:

- German Federal Ministry of Digital Affairs and Transport (BMDV): www.bmvi.de
- German Technical and Scientific Association for Gas and Water (DVGW): www.dvgw.de
- German Association for Liquefied Gas (DVFG): www.dvfg.de

As long as the intervals at which the gas inspection must be carried out are not regulated by law, the DVGW recommends an inspection every two years.

Many camping site operators demand proof of a valid gas inspection when allocating a parking place.



- ▷ Any changes on the gas system must be carried out by a certified expert for gas systems.
- ▷ Even in the case of vehicles that are not registered, an inspection of the gas system is required.

13.2 Inspection work

Like any technical appliance, the vehicle must be inspected at regular intervals.

This inspection work must be carried out by qualified personnel.

Special technical knowledge, which cannot be taught within the framework of this instruction manual, is required for these tasks. Personnel possessing this technical knowledge are available for assistance at all service centres. Their experience and regular technical instruction by the factory as well as equipment and tools guarantee expert and up-to-date inspection of the vehicle.

The service centre in charge will confirm the work performed.

Have chassis inspections confirmed in the chassis manufacturer's customer service booklet.



- ▷ Observe the inspections indicated by the manufacturer and have them carried out at the specified intervals. The value of the vehicle is thus preserved.
- ▷ The confirmation of the inspection work carried out serves as valid proof in the event of damage and guarantee claims.

13.3 Maintenance and servicing work

General

The following sections describe the maintenance work required for optimum and trouble-free operation of the vehicle.

- If increased wear is detected on individual components during regular inspections, shorten the required maintenance intervals based on the actual signs of wear!

In addition to these instruction manual, the instructions for the appliances also apply. The instructions contained therein - in particular the safety instructions mentioned there - must be observed!

If you have any questions about maintenance work and intervals: contact the manufacturer. See reverse for address

Have the base vehicle and the appliances serviced at the intervals specified in the respective instructions.



- ▶ Risk of accident and injury due to improper maintenance!!
Improper maintenance or repair can lead to serious accidents or injuries.
Repairs to the vehicle/chassis, electrical system, gas supply and gas appliances may only be carried out by authorised qualified personnel.

13.3.1 Base vehicle

Inspection and maintenance serve to record actual conditions and restore target conditions. They are due depending on the mileage or time, starting with the takeover or initial registration.

Maintenance measures for the base vehicle (chassis) can be found in the instruction manual and the service booklet of the manufacturer of the base vehicle.

13.3.2 Fixed time interval

Interval	Component	Action required
Monthly	Tyres	Check air pressure
	Fresh water tank, grey water tank, and fresh water system	Clean and de-scale
Every six months (e.g. in spring and autumn)	Test switch for RCD protection	Press button, function check
Annually (every spring)	Overall vehicle	Water ingress test
	Doors, service hatches	Grease hinges
	Electrical system	Function check
Every 2 years	Overall vehicle	Main vehicle inspection
	Gas system	Gas inspection in accordance with DVGW worksheet G 607

13.4 Elevating roof

- Check belts and tongues for function and damage.
- To avoid a musty smell, air the canvas/bellows several times a year.
- Repair small damages in the bellows with the help of the repair kit. The repair kit is available from your specialist dealer.
- Have any other repairs and adjustments (both to the bellows and to other components) carried out only by an authorised specialist workshop.

13.5 Gas fired boiler (Whale)



- ▶ Have gas tightness and burner function checked by an approved specialist.



- ▷ The device contains components sensitive to ESD. Have device opened only by an authorized service centre.
 - Have boiler checked by an authorized service centre in accordance with the applicable local provisions at least once a year.
 - Fully sterilize the boiler at least once a year.
 - Use a sterilization liquid that complies with the manufacturer's specifications for cleaning and sterilizing.
 - If the water system has not been used for a period longer than 7 days, empty the water system completely and flush it thoroughly before filling it again.
 - In order to protect the pressure relief valve from calcifications: actuate the pressure relief valve at least twice a year. In order to do this, turn lever of the drain cock through 90° in an anticlockwise direction.

13.6 Replacing illuminants, external



- ▷ The following section describes how to change the illuminants in the rear lights. For information on the front lights and the lights on the side of the vehicle, see the separate instruction manual for the base vehicle.

The rear lights are not directly accessible. Fittings must be removed first to be able to change the illuminants on the right-hand or left-hand bedding box.

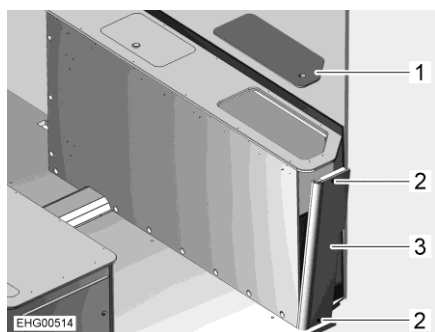

Fig. 109 Bedding box on the right

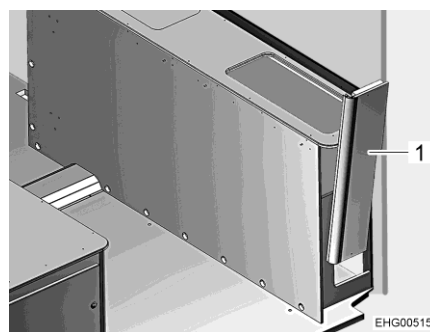

Fig. 110 Bedding box on the right, side wall

Changing illuminant (right-hand rear light):

- Remove the service cover (Fig. 109,1).
- Unscrew 2 screws (Fig. 109,2).
- Reach into the bedding box from above and press the side wall (Fig. 109,3) slightly outwards.
- Remove the side wall (Fig. 110,1) upwards with light shaking movements.

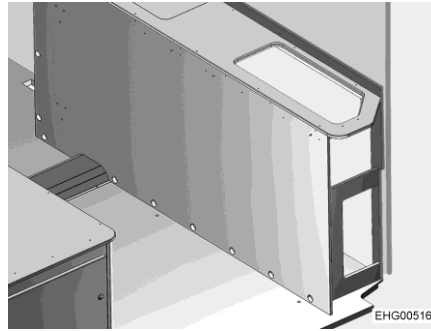

Fig. 111 Access to illuminant at the rear right

- Change the illuminant through the orifice in the bedding box.
- Insert the side wall from above and push it downwards.
- Fix the side wall with 2 screws.
- Close the bedding box with the service cover.

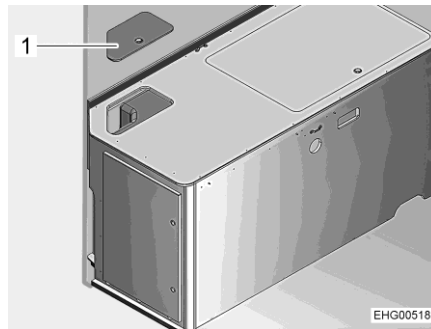

Fig. 112 Bedding box on the left

Changing illuminant (left-hand rear light):

- Remove the service cover (Fig. 112,1).
- Change the illuminant through the orifice in the bedding box.
- Close the bedding box with the service cover.

13.7 Replacing illuminants, internal



- ▶ Do not replace the LEDs in lamps with standard light bulbs. Risk of fire due to intense heat build up.



- ▷ If LEDs in lights are defect, contact an authorised dealer or service centre.

13.8 Spare parts



- ▶ Every alteration of the original condition of the vehicle can alter road behaviour and jeopardize road safety.
- ▶ The optional equipment and original spare parts recommended by us have been specially developed and supplied for your vehicle. These products are available at your dealer. The dealer is informed about admissible technical details and carries out the required work correctly.
- ▶ The use of accessories, parts and fittings not supplied by us may cause damage to the vehicle and jeopardize road safety. Even if an expert's report, a general type approval or a design certification exists, there is no guarantee for the proper quality of the product.
- ▶ No liability can be assumed for damage caused by products which have not been released by us. This also applies to impermissible alterations to the vehicle.

For safety reasons, spare parts for pieces of equipment must correspond with manufacturer's instructions and be permitted by the manufacturer as a spare part. These spare parts may only be fitted by the manufacturer or an authorised specialist workshop. The authorised dealers and service centres are available for any spare parts requirement.

When ordering spare parts, please indicate the serial number and the vehicle type to the dealer.

13.9 Vehicle identification plate

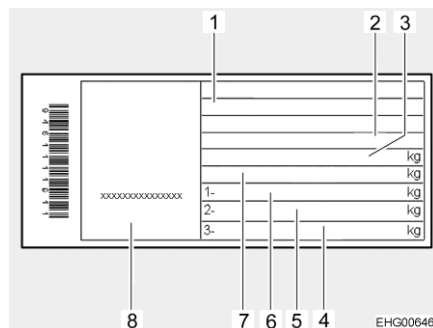

- 1 Type
- 2 Manufacturer's code and chassis number
- 3 Technically permissible maximum laden mass of the vehicle
- 4 Free
- 5 Technically permissible maximum laden mass on the rear axle
- 6 Technically permissible maximum laden mass on the front axle
- 7 Technically permissible maximum laden mass of the vehicle with trailer
- 8 Serial number

Fig. 113 Vehicle identification plate

The vehicle identification plate (Fig. 113) with the serial number is fitted on the B column on the front passenger side.

Do not remove the vehicle identification plate. The vehicle identification plate:

- Identifies the vehicle
- Helps with the procurement of spare parts
- Together with the vehicle documents identifies the vehicle owner



- ▶ Always include the **serial number** with all inquiries for the customer service office.

13.10 Warning and information stickers

There are warning and information stickers on and inside the vehicle. Warning and information stickers are for the sake of safety and must not be removed.



- ▷ Replacement stickers can be obtained from an authorised dealer or a service centre.

13.11 Dealers

Contact your authorised dealer or service centre whenever spare parts are needed for the vehicle.

You can find the addresses and telephone numbers of the authorised dealers and service centres on the web at the homepage of the manufacturer.

Chapter overview

This chapter contains instructions regarding the tyres of the vehicle.

At the end of the chapter there is a table you can use to find the correct tyre pressure for your vehicle.

14.1 General



- ▶ Check tyre pressure before a journey or every 2 weeks. Wrong tyre pressure causes excessive wear and can lead to damage or even to tyre burst. You can lose control of the vehicle (see section 14.6).



- ▷ Check the tyre pressure on cold tyres. Do not reduce the higher tyre pressure when the tyres are warm.
- ▷ Tubeless tyres have been installed on the vehicle. Never install tubes in these tyres.
- ▷ Read the instruction manual for the base vehicle.



- ▷ Depending on the model, the vehicle may only be equipped with a tyre repair kit as standard.
- ▷ In the case of a puncture, pull the vehicle over to the side of the road. Make vehicle safe with a hazard warning triangle. Switch on the warning lights.
- ▷ Tyres must not be older than 6 years as the material will become brittle over time. The four-digit DOT number on the tyre flank indicates the date of manufacture. The first two digits designate the week, the last two digits the year of manufacture.
Example: (0722) Week 07, year of manufacture 2022.
- ▷ The on-board tool set is stowed in the bedding box on the left.

- Observe:**
- Check the tyres regularly (every 2 weeks) for equal tread wear, tread depth and external damage.
 - Replace tyres at the latest, when the minimum depth of tread stipulated by law is reached.
 - Always use tyres of the same model on one axle.
 - Observe the instructions in the vehicle documents.
 - Only use tyres approved for the wheel rim type fitted. The permitted rim and tyre sizes are quoted in the vehicle documents and the authorised dealer or service centre will always be glad to give you advice.
 - Run-in new tyres for approx. 100 km (60 miles) at low speed since only then do they reach full strength.

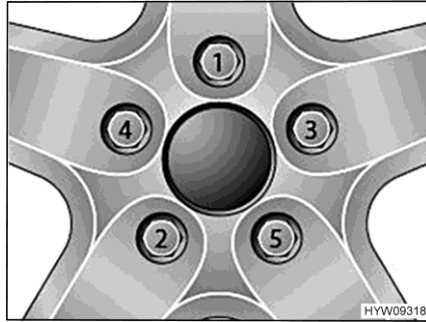

Fig. 114 Tightening the wheel nuts or wheel bolts cross-wise

- Tighten the wheel nuts or wheel bolts in the order shown in Fig. 114. In order to do this, use a torque wrench and comply with the specified tightening torque (see section 14.5).
- Check regularly that the wheel nuts or wheel bolts are firmly seated. Re-tighten the wheel nuts or wheel bolts of a changed wheel after 50 km (30 miles). While doing so, proceed in the order shown in Fig. 114.
- When using new or newly painted rims, re-tighten the wheel nuts or wheel bolts once again after approx. 1,000 to 5,000 km (600 miles to 3,000 miles). While doing so, proceed in the order shown in Fig. 114.
- For lay-ups or long periods of inactivity, keep the tyres and tyre bearings free from pressure points:
Jack up the vehicle so that the wheels do not bear any load, or move the vehicle every 4 weeks in such a way that the position of the wheels is changed.

14.2 Tyre selection



- ▶ A wrong tyre can damage the tyres during the journey and even cause it to burst.



- ▷ If tyres that are not approved for the vehicle are used, then the type approval for the vehicle and subsequently the insurance coverage can lapse. The authorised dealer or service centre will be happy to advise you.

The tyre sizes approved for the vehicle are given in the vehicle documents or can be obtained from the authorised dealers or service centres. Each tyre must fit the vehicle on which it will be driven. This applies to the external dimensions (diameter, width), which are indicated with the standardised size designations. In addition, the tyres must meet the requirements of the vehicle with regard to weight and speed.

The weight is based on the technically permissible maximum laden mass on the axle, which is distributed between two tyres. The maximum load-carrying capacity of a tyre is indicated by its load index (= LI, load index code).

The maximum permissible speed for a tyre (with full load-carrying capacity) is indicated by the speed index (= SI). Together, load index and speed index form the operating code of a tyre. This is an official component of the complete, standardised dimensions description which appears on every tyre. The information on the tyres must correspond to the specifications which appear in the vehicle papers.

14.3 Tyre specifications

215/70 R 15C 109 Q
(example)

Description	Explanation
215	Tyre width in mm
70	Height-to-width proportion in percent
R	Tyre design (R = radial)
15	Rim diameter in inches
C	Commercial (transporter)
109	Load index code for single tyres
Q	Speed index (Q = 160 km/h)

14.4 Handling of tyres

- Drive over kerbs at an obtuse angle. Otherwise the flanks of the tyres may get pinched. Driving over a kerb at a sharp angle can damage the tyre and result in it getting ruptured.
- Drive over high manhole covers at a slow speed. Otherwise the tyres may get pinched. Driving over a high manhole cover at high speed can damage the tyre and result in it getting ruptured.
- Check the shock absorbers regularly. Driving with poor shock absorbers significantly increases wear.
- In the event of an uneven thread wear, contact customer service.
- Do not clean the tyres with a high-pressure cleaner. The tyres can suffer serious damage within just a few seconds and rupture as a result.
- Drive the tyres with care. Avoid braking sharply, revving up too strongly and journeys on poor roads.

14.5 Tightening torque

Wheel rim	Tightening torque
Steel wheel rim 15"	160 Nm
Steel wheel rim 16"	180 Nm
Alloy wheel rim 15"	140 Nm
Alloy wheel rim 16"	160 Nm

14.6 Tyre pressure



- ▶ Tyres overheat if the tyre pressure is too low. This can cause serious tyre damage.
- ▶ Check tyre pressure before a journey or every 2 weeks. Wrong tyre pressure causes excessive wear and can lead to damage or even to tyre burst. You can lose control of the vehicle.
- ▶ Use only valves that are approved for the specified tyre pressure.
- ▶ Only use tyres that are specified in the vehicle title.



- ▷ Check the tyre pressure on cold tyres. Do not reduce the higher tyre pressure when the tyres are warm.



- ▷ Information stickers with the required tyre pressure are attached to the inside of the B column (see Fig. 116).

The payload and the durability of tyres is directly dependent on the tyre pressure. Air is a volatile medium. It is unavoidable that it will escape from tyres.

As a rule of thumb it can be assumed that a filled tyre loses pressure at a rate of 0.1 bar every two months. To prevent the tyres becoming damaged or burst, check the tyre pressure regularly.

The contact surface of the tyre changes, depending on the tyre pressure.

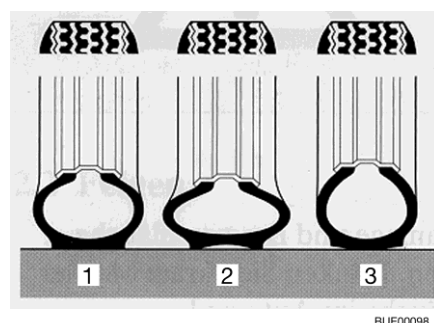

- 1 Correct tyre pressure
- 2 Tyre pressure too low
- 3 Tyre pressure too high

Fig. 115 Contact surface of the tyre



- ▷ The information on pressure levels is valid for cold tyres and loaded vehicles.
- ▷ Pressure in hot tyres is higher than in cold tyres. Therefore, check the pressure when the tyres are cold.
- ▷ Tyre pressures in bar.
- ▷ Over 4.75 bar requires a metal valve.
- ▷ When a replacement is needed, we recommend "Camping" tyres.

The vehicles are constantly brought up to the newest technical standards. It is possible that new tyre sizes are not yet included in this table. If this is the case, any dealer will be happy to provide the newest values.

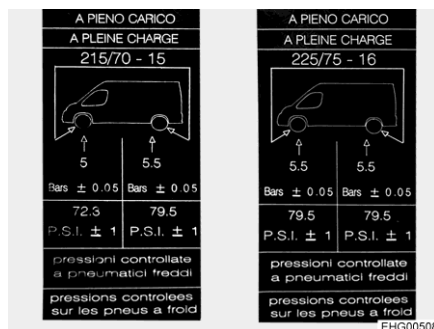

Fig. 116 Tyre pressure information sticker on B column (example)

Standard tyres	Type of tyres	Front air pressure in bar	Rear air pressure in bar
215/70 R15 CP	Motorhome tyres	5.0	5.5
225/75 R16 CP	Motorhome tyres	5.5	5.5

Chapter overview

This chapter contains instructions about possible faults in your vehicle. The faults are listed with their possible causes and corresponding remedies. The specified faults can be remedied with relative ease and without a great deal of specialised knowledge. In the event that the remedies detailed in this instruction manual should not be successful, an authorised specialist workshop must find and eliminate the cause of the fault.

15.1 Braking system



- ▶ Have defects on the braking system immediately remedied by an authorised specialist workshop.

15.2 Electrical system



- ▷ When the living area battery is changed, only use batteries of the same type and the same capacity.



- ▷ See chapter 9 for changing the fuses.

Fault	Cause	Remedy
Road light system does no longer work correctly	Bulb is defective	Replace bulb. Note volts and watts specifications
	Fuse is defective	Replace fuse
Interior lighting does not work	Illuminant, plug connector or cable faulty	Contact customer service
The electrically operated entrance step cannot be moved in or out	Fuse on the transformer/rectifier is defective	Replace fuse on the transformer/rectifier
The entrance step does not extend or only partially (in the winter)	The mechanics are iced up	Clean the entrance step, remove ice
	The protection device (pinch protection) has triggered due to a overload current	
No 230 V power supply in spite of connection	230 V automatic circuit breaker has triggered	Switch on 230 V automatic circuit breaker

Fault	Cause	Remedy
Starter or living area battery is not charged when operated in 230 V mode	Jumbo flat fuse on the starter or living area battery is defective	Replace jumbo flat fuse on the starter or living area battery
	No mains voltage	Switch on automatic circuit breaker in the vehicle
	Transformer/rectifier is overheated	Ambient temperature too high or transformer/rectifier ventilation hindered
	Too many appliances are switched on	Switch off appliances that are not required
	Charger module in the transformer/rectifier is defective	Contact customer service
Living area battery is not charged during vehicle operation	Fuse on terminal D+ of the alternator is defective	Replace fuse
	Disconnecter relay in the transformer/rectifier is defective	Contact customer service
12 V indicator lamp does not light up	12 V power supply is switched off	Switch 12 V power supply on
	Battery cut-off switch on the transformer/rectifier is switched off	Set battery cut-off switch to on
	Starter or living area battery is not charged	Charge the starter or living area battery
	Disconnecter relay in the transformer/rectifier is defective	Contact customer service
	Flat fuse on the living area battery is defective	Replace flat fuse on the living area battery
12 V power supply does not work	12 V power supply is switched off	Switch 12 V power supply on
	Battery cut-off switch on the transformer/rectifier is switched off	Set battery cut-off switch to on
	Living area battery is discharged	Charge the living area battery
	Jumbo flat fuse on the living area battery is defective	Replace jumbo flat fuse on the living area battery
	Disconnecter relay in the transformer/rectifier is defective	Contact customer service

Fault	Cause	Remedy
12 V power supply does not work in 230 V operation	12 V power supply is switched off	Switch 12 V power supply on
	Battery cut-off switch on the transformer/rectifier is switched off	Set battery cut-off switch to on
	230 V automatic circuit breaker has triggered	Contact customer service
	Charger module in the transformer/rectifier is defective	Contact customer service
	Jumbo flat fuse on the living area battery is defective	Replace jumbo flat fuse on the living area battery
230 V indicator lamp does not light up even though 230 V mains supply is connected	The mains connection is de-energised	Check external mains connection
	230 V automatic circuit breaker upstream of transformer/rectifier has tripped or is switched off	Reset 230 V automatic circuit breaker
No voltage at a connected appliance	Self-resetting Polyswitch fuse has tripped	Check plug connectors and cables. Switch off 12 V power supply for approx. 2 minutes, then switch it back on
	Self-resetting Polyswitch fuse has tripped several times (3 times), system has deactivated corresponding output permanently	Remedy cause of Polyswitch tripping Cancel permanent switch-off (switch on 12 V power supply for living area, press rotary knob and keep it pressed for minimum 3 seconds)
Starter battery is discharged in 12 V operation	Disconnecter relay in the transformer/rectifier is defective	Contact customer service
	Battery cut-off switch on the transformer/rectifier is switched off	Set battery cut-off switch to on
No voltage is supplied by the living area battery	Living area battery is discharged	<p>Charge living area battery immediately</p> <p> Total discharge damages the battery.</p> <p>If the vehicle is to be laid up for a long period, fully charge the living area battery beforehand</p> <p>Discharging is caused by inactive appliances (see chapter 9)</p>

Fault	Cause	Remedy
Battery charge through solar module not working	Electrical connection to solar module interrupted	Check plug connectors and cables
	Fuse is defective	Replace fuse on the transformer/rectifier
	Solar charge regulator defective	Contact customer service
Living area battery overloaded ("hot")	Battery selection switch set wrongly	Move position of battery selection switch
	Defective load sensor or relay	Pull out the jumbo flat fuse on the living area battery, then contact customer service

15.3 Gas system



- ▶ In case of a defect of the gas system (gas odour, high gas consumption) there is danger of explosion! Close regulator tap on the gas bottle immediately. Open doors and windows and ventilate well.
- ▶ If the gas system is defective: Do not smoke; do not ignite any open flames, and do not operate electric switches (light switches etc.). Check the tightness of gas-conducting parts and lines with leakage search spray. Do not check with an open flame.
- ▶ Have the defective gas system repaired by an authorised specialist workshop.

Fault	Cause	Remedy
No gas	Gas bottle is empty	Change gas bottle
	Gas isolator tap closed	Open the gas isolator tap
	Regulator tap on the gas bottle is closed	Open regulator tap on the gas bottle
	External temperature is too low (-42 °C for propane gas, 0 °C for butane gas)	Wait for higher external temperatures
	Built-in appliance is defective	Contact customer service

15.4 Cooker

Fault	Cause	Remedy
Ignition fuse does not operate (flame does not burn after the control knobs are released)	Heat-up time is too short	Keep control knob pressed for approx. 15 to 20 seconds after ignition
	Ignition fuse is defective	Contact customer service
Flame extinguishes when being reduced to its minimum setting	Thermocouple sensor is incorrectly set	Correctly reset thermocouple sensor (do not bend). The sensor tip should protrude by 5 mm beyond the burner. The sensor neck should not be more than 3 mm away from the burner ring; if necessary, contact customer service

15.5 Heater/boiler

Fault	Cause	Remedy
Heater does not ignite	Temperature sensor on operating unit or remote sensor defective	Pull out plug on operating unit. The heater then works without thermostat. Contact the customer service as soon as possible
Boiler empties, safety/drainage valve has opened	Internal temperature below 3 °C	Heat inside
Safety/drainage valve cannot be closed	Temperature at safety/drainage valve below 8 °C	Heat inside
Fan wheel runs noisily or not steadily	Fan wheel is soiled	Contact Truma service department
None of the LEDs comes on, device is switched on, operating voltage is connected	Automatic restart is blocked, e.g. following an interruption of the power supply	Reset the device (switch off, wait 5 seconds, switch on again)
After switching on (winter and summer operation) none of the LEDs comes on	No operating voltage	Check 12 V battery voltage, load battery if necessary
	Appliance fuse or vehicle fuse defective	Check all electrical plug connectors Check appliance fuse or vehicle fuse and replace if necessary
After switching on, the green LED comes on but the heater does not work	The temperature set on the control unit is below room temperature	Set a higher temperature on the control unit

Fault	Cause	Remedy
Green LED comes on, red LED flashes	The safety switch on the window above the waste gas vent has triggered	Close the window
	Risk of undervoltage; battery voltage too low < 10.4 V	Charge the battery
The heater permanently toggles between minimum and maximum power	Air circulation suction system blocked	Remove blocking of air circulation suction system
Red LED comes on, approximately 30 seconds after the heater is switched on	Regulator tap on the gas bottle or the gas isolator tap is closed	Open regulator tap or gas isolator tap
	Gas bottle is empty	Change gas bottle
	Combustion air inlet or exhaust gas outlet closed	Uncover openings
After extended operation, heater registers a fault	Gas pressure regulator deiced up	Use regulator heater (de-froster)
	Level of butane in the gas bottle too high	Use propane gas (butane gas is unsuitable for heating especially for temperatures under 10 °C)
	Warm air louvres blocked	Remove blocking
Green LED is flashing after switching the heater off	Overrun is active to reduce temperature of appliance	No error; overrun switches off after approximately 5 minutes
After the appliance is switched on, the green and red LEDs come on	Electronics defective	Contact customer service

If these measures do not lead to the elimination of the fault, contact the nearest customer service workshop of the relevant appliance manufacturer. The list of addresses is enclosed with the accompanying appliance documentation. Only authorised qualified personnel may repair the appliance.

15.5.1 Independent vehicle heater (Webasto)

See the manufacturer's documentation for any information on causes and correction of faults.

15.6 Refrigerator

15.6.1 General

In the event of a defect contact the nearest customer service workshop of the relevant appliance manufacturer. The list of addresses is enclosed with the accompanying appliance documentation. Only authorised qualified personnel may repair the appliance.



- ▷ Further information can be obtained in the manufacturer's instruction manual.

Fault	Cause	Remedy	
Refrigerator is cooling very intensely	Set cooling level is too high	Set lower cooling level	
Compressor does not run	No supply voltage	Charge the battery Contact customer service if necessary	
	Battery voltage too low	Charge the battery	
	Battery capacity too low	Change the battery	
	Ambient temperature is too high	If possible, ensure a lower ambient temperature (e.g. park the vehicle in the shade)	
	Ventilation insufficient		Keep the ventilation slots clear Contact customer service if necessary
Cooling power decreases, internal temperature increases	Ambient temperatures are too high	If possible, ensure a lower ambient temperature (e.g. park the vehicle in the shade)	
	Ventilation insufficient	Keep the ventilation slots clear Contact customer service if necessary	
	Battery capacity low	Charge the battery	
Unusual noises	Fan noise	Contact customer service if necessary	

15.7 Water supply

Fault	Cause	Remedy
Leakage water inside the vehicle	A leak has occurred	Identify leak, re-connect water pipes
No water	Water tank is empty	Replenish drinking water
	Drain cock not closed	Close drain cock
	12 V power supply is switched off	Switch 12 V power supply on
	Switch for water pump is off	Switch water pump on
	Fuse of the water pump is defective	Replace fuse on the transformer/rectifier
	Water pump defective	Exchange water pump (have it exchanged)
	Water pipe snapped off	Straighten water pipe or replace
	Transformer/rectifier defective	Contact customer service
Toilet has no flush water	Water tank is empty	Replenish drinking water
Display for water and waste water indicates a wrong value	Measuring probe in the waste water or water tank is soiled	Clean water/waste water tank
	Measuring probe is defective	Replace measuring probe
Waste water tank cannot be emptied	Drain cock is clogged	Open the cleaning cap on the waste water tank and drain the waste water. Rinse the waste water tank well
Drain on the single lever mixer tap is clogged	Perlator calcified	Unclip the perlator, de-calcify in vinegar water (only for products made from metal)
Water jets on the shower nozzle clogged	Water jets calcified	De-calcify shower nozzle in vinegar water (only for products made from metal) or rub off soft nozzle burling
Water drains from the shower tray slowly or does not drain at all	The vehicle is not in a horizontal position	Position the vehicle horizontally
Milkieness of the water	Tank filled with dirty water	Clean water tank mechanically and chemically; then disinfect and rinse copiously with drinking water
	Residues in the water tank or water system	Clean water system mechanically and chemically; then disinfect and rinse copiously with drinking water

Fault	Cause	Remedy
Any change in the taste or odour of the water	Tank filled with dirty water	Clean water system mechanically and chemically; then disinfect and rinse copiously with drinking water
	Fuel filled into the water tank by mistake	Clean water system mechanically and chemically; then disinfect and rinse copiously with drinking water. If not successful: Contact a specialist workshop
	Microbiological deposits in the water system	Clean water system mechanically and chemically; then disinfect and rinse copiously with drinking water
Deposits in the water tank and/or water-carrying components	Water excessively long in the water tank and in water-carrying components	Clean water system mechanically and chemically; then disinfect and rinse copiously with drinking water

15.8 Body

Fault	Cause	Remedy
Flap hinges/door hinges are difficult to operate	Flap/door hinges are not (sufficiently) lubricated	Lubricate flap hinges/door hinges with acid-free and resin-free grease
Hinges/joints in the bathroom unit/toilet compartment are difficult to operate/make a grating noise	Hinges/joints are not (sufficiently) lubricated	Lubricate hinges/joints with solvent-free and acid-free grease  ▷ Spray cans often contain solvents
Storage compartment hinges are difficult to operate/make a grating noise	Storage compartment hinges are not (sufficiently) lubricated	Lubricate storage compartment hinges with acid-free and resin-free grease



▷ The authorised dealers and service centres are available for any spare parts requirement.

Model	Seats	Sleeping places	Outer dimensions L / W / H (in cm)
C 540 / CV 540	4	2	541 / 205 / 265
C 590 / CV 590	4	2 / 3 (OPT)	599 / 247 / 291
C 600 / CV 600	4	2 / 3 (OPT)	599 / 205 / 265
C 601 / CV 601	4	4 / 5 (OPT)	599 / 205 / 265
C 640 / CV 640	4	2 / 3 (OPT)	636 / 205 / 265

OPT = number of sleeping places in case of optional equipment.

Refer to the vehicle documents or the instruction manual of the base vehicle for further information on technical data.

Chapter overview

This chapter contains helpful tips for the journey.

At the end of the chapter there is a checklist containing the most important equipment for the journey.

17.1 Traffic rules in foreign countries



- ▷ The vehicle driver is required to inform himself as to the traffic rules of the countries in which he plans to travel before beginning the trip. Contact your automobile club or embassy for further information.
- ▷ In some European countries, warning vests must be worn when exiting the vehicle outside of towns in the case of vehicle failures or accidents.
- ▷ Depending on the country, different rules and regulations apply (e.g. different warning signs for rear carriers, obligation to carry breathalyzer kits, spare bulbs, high-visibility vests, size of reserve canister). The driver of the vehicle must familiarise him or herself with these rules before every journey.
- ▷ Up-to-date information can generally be found on the web pages of the national automobile associations.

Information about traffic regulations is especially important as state law applies in case of damage. For your own safety, always observe the following rules when travelling abroad:

- Carry your insurance certificate with you.
- Always register accidents with the police.
- Never sign documents that you have not read and understood completely.

17.2 Help on Europe's roads



- ▷ Before commencing the trip, gather information on national phone numbers for rescue and police. In many countries the central emergency phone number 112 (without area code) applies.
- ▷ As far as possible, draw up a list with the important phone numbers in the travelled countries and keep the table in the vehicle.

Motoring clubs at home or in the travelled country are happy to help.

17.3 Gas supply in European countries



- ▷ In Europe, there are several different connection systems for gas bottles. It is not always possible to fill or exchange your gas bottles in a foreign country. Get information about the connection system in the country you are travelling to before embarking on your journey, e.g. at a motoring club or in the trade press.

General tips

Always observe the following instructions:

- Only go on vacation with completely filled gas bottles.
- Use all of the gas bottles' capacity.
- Take along adapter sets (available in camping supply stores) for filling gas bottles in foreign countries and for connecting the gas pressure regulator to foreign gas bottles.
- During the cold time of the year observe filling with propane gas component (butane does not gas below 0 °C).
- Use blue bottles from the firm Campingaz (distributed world-wide). Only use gas bottles with safety valves.
- When bottles from other countries are used, check the gas bottle compartments to see if the gas bottles fit into them. Gas bottles from other countries do not always display the same size as your own gas bottles.
- The web site www.mylpg.eu provides an overview of gas suppliers in Europe.

17.4 Toll regulations in European countries

Many European countries have introduced a mandatory toll system. The toll regulations and how they are collected vary greatly from country to country. Nevertheless, ignorance is no excuse. Penalties can be quite severe.

As is the case with traffic regulations, the vehicle driver is required to be familiar with the toll formalities before starting out on a trip. For example, in Austria the vignette does not meet the toll requirements for vehicles that weigh more than 3.5 t. There, a so-called "Go-Box" must be obtained and charged.

Contact your automobile club or the Internet for further information.



- ▷ Windscreens with solar filters can affect the functioning of automatic toll collection systems (e.g. Go-Box). This must be taken into account when acquiring the appropriate device (e.g. Split-Go-Box).

17.5 Tips on staying overnight safely during travel

Prudent behaviour is the most important protective measure for insuring a safe night in the vehicle.

The risk of thievery is reduced to a minimum when the following basic rules are observed:

- During high season do not spend the night at highway rest stops or parking areas located along typical vacation routes.
- Several vehicles on one site at the same time do not necessarily decrease the chances of thievery occurring. Consult your own feelings about the parking site.
- Even if it is just for one night, go to a camping site.
- When parking on open space keep emergency routes clear. The way to the driver's seat should be clear. The ignition key should always be within reach.
- Only take with you those valuables which are absolutely necessary for the journey. If possible, store valuables in a small safe and not in the immediate vicinity of windows or doors.
- Always lock up the vehicle.

17.6 Tips for winter campers

The following tips will help make your winter camping experience as agreeable as possible.

- Reserve your parking place in good time. Good winter camping sites are often booked up early.
- Do not start your trip without winter tyres.
- Bring snow chains.
- Choose your parking place with care. Observe the ground beneath you. Snow and ice may melt.
- When the vehicle has been positioned, release the handbrake to prevent freezing.
- No snow walls should be allowed to cover the built-in forced ventilation.
- Keep the built-in forced ventilation free from snow and ice.
- Make sure the air circulation is good. Good air circulation prevents moisture from collecting and makes it easier to heat the living area.
- Cover the single-paned driver's cabin window with insulation mats to avoid thermal bridges.
- Follow the instructions in the section "Gas supply in European countries".
- Use a two-bottle system with automatic controller for the gas system, so that the supply does not run out during the night.
- Only operate the gas system using propane gas.
- Do not use the space behind the heater as a storage space.
- Never operate catalytic ovens or infra-red gas radiators in the interior of the vehicle, since they consume oxygen for burning.
- Lay the 230 V power cable in such a way that the cable cannot be frozen or be damaged (e.g. during snow removal).
- When it is snowing heavily, clear the roof of the vehicle of snow regularly. A few centimetres of powdery snow serves as insulation, but wet snow quickly becomes a heavy burden.
- Before embarking on the return journey, remove all the snow from the roof to avoid impeding vehicles behind you with a "snow flag".

17.7 Travel checklists

The following checklists will help that nothing important is left at home although not everything on the checklists might be necessary.



- ▷ Do not leave checking of documents (e.g. vehicle papers and information) as well as checking the condition of the vehicle until just before commencing the trip. Planning and checking documents well in advance will save unnecessary trouble.

Kitchen area

✓	Object	✓	Object	✓	Object
	Wiping cloth		Cleansing agent (detergent)		Salad servers
	Silverware		Dishcloths		Chopping board
	Turnspit		Glasses		Brush to wash the dishes
	Can opener		Set of knives and forks for grilling		Cloth to wash the dishes
	Ice cube tray		Corkscrew		Matches
	Lighter		Kitchen paper		Thermos jug
	Bottle opener		Garbage bags		Pots
	Air-tight storage boxes		Frying pans		
	Crockery		Stirring spoons		

Bathroom/sanitary items

	Towels		Sanitary items		Toilet paper
	Hygiene products		Toilet brush		Toothbrush glass

Living area

	Dustbin		Deck of cards		Rucksack
	Road atlas		Broom		Sleeping bags
	Bath towels		Dust pan		Pencils and paper
	Bath shoes		Candles		Shoes
	Batteries		Coat-hangers		Shoe polish
	Bed linen		Clothes brush		Sports equipment
	Laundry bag		Pillow		Vacuum cleaner
	Books		Map		Flash light
	Camping guide/parking space directory		Medicine		Pocket knife
	Binoculars		Mobile phone		Table cloth
	Fire extinguisher		Sewing kit		Drinking bottle
	Gas bottle		Rain clothes		Clothes pins
	Insect lamp		First aid kit		Clothesline
	Insect repellent		Travel guide		

Vehicle/tools

✓	Object	✓	Object	✓	Object
	Waste water container		Gas tube		Snow chains (winter)
	Adapter socket		Fabric tape		Screwdriver
	CEE adapter		Watering can for drinking water		Current-measuring instrument
	Wire		Cable reel		Wheel chocks
	Spare wheel		Glue		First-aid kit
	Spare lamps		Universal pliers		Vehicle jack
	Spare fuses		Compressor		Hazard warning triangle
	Hammer		Loops		Warning sign
	Flat wrench		Tube adapter		Warning vest(s)
	Gas filling adapter		Hose clips		Flashing hazard warning light

Outside

	Stay rope		Camping table		Lock
	Bellows		Luggage racks		String
	Camping chairs		Grill		Tent pegs/tightening ropes

Documents

	List of addresses		Registration book		Passport
	Registration confirmation(s)		Driving licence		Writ of protection
	Allergy certificate		Vaccination certificate		Insurance documents
	Instruction manuals		Credit card		Vignette/toll card
	Instruction leaflets for medicines		Identity card		Visa

The weight specifications and tests for motorhomes are uniformly regulated throughout the EU in EU Implementing Regulation No. 2021/535 (until June 2022: EU Implementing Regulation No. 1230/2012). We have summarised and explained the key terms and legal requirements from this regulation for you below. Our dealers and the LMC configurator on our website offer you additional assistance in configuring your vehicle.

1. Technically permissible maximum laden mass

The technically permissible maximum laden mass of the vehicle (e. g. 3,500 kg) is a mass specification set by the manufacturer which the vehicle must not exceed. Information on the technically permissible maximum laden mass of the model you have chosen can be found in the technical data. If the vehicle exceeds the technically permissible maximum laden mass in everyday driving, this constitutes an administrative offence which may result in a fine.

2. Mass in running order

In simple terms, the mass in running order is the basic vehicle with standard equipment plus a legally fixed standard weight of 75 kg for the driver. This essentially includes the following items:

- the unladen weight of the vehicle together with the bodywork, including operating fluids such as greases, oils and coolants;
- the standard equipment, i.e. all equipment items that are included as standard in the factory-fitted scope of delivery;
- the fresh water tank filled to 100 % in driving mode (driving fill according to manufacturer's specifications; 20 litres) and an aluminium gas cylinder filled to 100 % with a weight of 16 kg;
- the fuel tank, which is 90 % full, including fuel;
- the driver, whose weight – regardless of the actual weight – is generally specified as 75 kg in accordance with EU law.

Information on the mass in running order can be found for each model in our sales documents. It is important to note that the value for mass in running order given in the sales documents is a default value determined in the type-approval procedure and verified by the authorities. It is legally permissible and possible for the mass in running order of the vehicle delivered to you to deviate from the nominal value stated in the sales documents. The legally permissible tolerance is $\pm 5\%$. In this way, the EU legislator accounts for the fact that certain fluctuations in the mass in running order occur due to variations in the weight of supplied parts as well as due to processes and weather conditions.

These weight deviations can be illustrated by means of an example calculation:

- Mass in running order acc. to sales documents: 2,850 kg
- Legally permissible tolerance of $\pm 5\%$: 142.50 kg
- Legally permissible range of mass in running order: 2,707.50 kg to 2,992.50 kg

The specific range of permissible weight deviations can be found for each model in the technical data. LMC makes great efforts to reduce weight variations to the minimum that is unavoidable for production reasons. Deviations at the upper and lower end of the range are therefore very rare; however, they cannot be completely ruled out technically, even with all optimisations. The real weight of the vehicle and compliance with the permissible tolerance is therefore checked by LMC by weighing each vehicle at the end of the line.

3. Mass of the passengers

The mass of the passengers is set a standard value of 75 kg for each seat provided by the manufacturer, regardless of the actual weight of the passengers. The mass of the driver is already included in the mass in running order (see no. 2 above) and is therefore not included again. In the case of a motorhome with four permitted seats, the mass of the passengers is therefore $3 \times 75 \text{ kg} = 225 \text{ kg}$.

4. Optional equipment and actual mass of the vehicle

Optional equipment (also: additional equipment) includes, according to the legal definition, all optional equipment parts not included in the standard equipment which are fitted to the vehicle under the responsibility of the manufacturer – i.e. ex works – and can be ordered by the customer (e. g. awning, bicycle or motorbike carrier, satellite system, solar system, oven, etc.). Information on the individual or package weights of the optional equipment that can be ordered can be found in our sales documents. Optional equipment in this sense does not include other accessories that are retrofitted by the dealer or you personally after the vehicle has been delivered ex works.

The mass of the vehicle in running order (see no. 2 above) and the mass of the optional equipment fitted to a specific vehicle at the factory are together referred to as the actual mass. You will find the corresponding information for your vehicle after handover under item 13.2 of the Certificate of Conformity (CoC). Please note that this specification also represents a standardised value. Since the mass in running order – as an element of the actual mass – is subject to a legally permissible tolerance of $\pm 5 \%$ (see no. 2), the actual mass may also deviate accordingly from the stated nominal value.

5. Pay-mass and minimum pay-mass

The installation of optional equipment is also subject to technical and legal limits: Only so much optional equipment can be ordered and fitted at the factory that sufficient free weight remains for baggage and other accessories ("pay-mass") without exceeding the technically permissible maximum laden mass. The pay-mass is calculated by subtracting the mass in running order (nominal value according to sales documents, see no. 2 above), mass of the optional equipment and the mass of the passengers (see no. 3 above) from the technically permissible maximum laden mass (see no. 1 above). The EU regulations stipulate a fixed minimum pay-mass for motorhomes, which must remain as a minimum for baggage or other non-factory-fitted accessories. This minimum pay-mass is calculated as follows:

Minimum pay-mass in kg $\geq 10 \times (n + L)$

Where: "n" is the maximum number of passengers plus the driver and "L" is the overall length of the vehicle in metres.

For a motorhome with a length of 6 m and 4 approved seats, the minimum pay-mass is therefore e. g. $10 \text{ kg} \times (4 + 6) = 100 \text{ kg}$.

To ensure that the minimum pay-mass is maintained, there is a maximum combination of optional equipment that can be ordered for each vehicle model. In the above example with a minimum pay-mass of 100 kg, the total mass of optional equipment for a vehicle with four permitted seats and a mass in running order of 2,850 kg should not exceed 325 kg:

3,500 kg technically permissible maximum laden mass
- 2,850 kg mass in running order
- 3 x 75 kg mass of the passengers
- 100 kg minimum pay-mass
= 325 kg maximum permissible mass of optional equipment

It is important to note that this calculation is based on the default value for mass in running order as defined in the type-approval procedure, without taking into account the permissible weight deviations for mass in running order (see no. 2 above). If the maximum permissible value for the optional equipment of (in the example) 325 kg is almost or completely exhausted, an upward weight deviation can therefore result in the minimum pay-mass of 100 kg being met mathematically using the default value for the mass in running order, although in fact there is no corresponding load capacity. Here, too, an example calculation for a vehicle with four seats, whose real weighed mass in running order is 2 % above the nominal value:

3,500 kg technically permissible maximum laden mass
- 2,907 kg real weighed mass in running order (+ 2 % compared to the stated value of 2,850 kg)
- 3 x 75 kg mass of the passengers
- 325 kg optional equipment (maximum permissible value)
= 43 kg actual load capacity (< minimum pay-mass of 100 kg)

In order to avoid such a situation, LMC further reduces the maximum permissible weight of the total optional equipment that can be ordered on a model-specific basis. The limitation of optional equipment is intended to ensure that the minimum pay-mass, i.e. the legally prescribed free mass for baggage and retrofitted accessories, is actually available for the vehicle load capacity of the vehicles delivered by LMC.

Since the weight of a specific vehicle can only be determined when it is weighed at the end of the line, in very rare cases a situation may arise in which the minimum pay-mass at the end of the line is not guaranteed, despite this limitation of optional equipment. In order to guarantee the minimum pay-mass even in these cases, LMC will check together with your trade partner and you before delivery of the vehicle whether, for example, the vehicle is loaded up, seats are reduced or optional equipment is removed.

6. Effects of tolerances of the mass in running order on the pay-mass

Regardless of the minimum pay-mass, you should note that unavoidable production-related fluctuations in the mass in running order – both upwards and downwards – have a mirror-image effect on the remaining load capacity: If you order our example vehicle (see no. 3. above), for example, with optional equipment with a total weight of 150 kg, the calculated pay-mass based on the default value for the mass in running order is 275 kg. The load capacity actually available may deviate from this value due to tolerances and may be higher or lower. If the mass in running order of your vehicle is, for example, permissibly 2 % higher than stated in the sales documents, the load capacity is reduced from 275 kg to 218 kg:

3,500 kg technically permissible maximum laden mass
- 2,907 kg real weighed mass in running order (+ 2 % compared to the stated value of 2,850 kg)
- 3 x 75 kg mass of the passengers
- 150 kg optional equipment ordered for the specific vehicle
= 218 kg actual load capacity

As a precaution to ensure that the calculated pay-mass is actually given, you should therefore take the possible and permissible tolerances for the mass in running order into account when configuring your vehicle.

We also recommend that you weigh the laden motorhome on a non-automatic scale before each journey and, taking the individual weight of the passengers into account, determine whether the technically permissible maximum laden mass and the technically permissible maximum mass on the axle are observed.

-
- 12 V fuses 87, 88
 For plus signal 88
 For Thetford toilet 89
 On the living area battery 88
 On the starter battery 87
 12 V main switch 82
 12 V power supply 74
 Switching on 82
 Troubleshooting 145
 230 V connection 41, 85
 Troubleshooting 143
 230 V fuse 89
 Position 89
 230 V fuse box 89
 230 V power supply 85
 230 V power supply see also 230 V
 connection 85
- A**
- Accessories, fitting 12
 Actual vehicle mass 18, 21
 Add-on parts see optional equipment 12
 Air outlet nozzles, adjustment 92
 Appliances 91
 Manuals 12
- B**
- Basic equipment 19
 Battery cut-off switch 80
 Battery monitor 81
 Battery see starter battery and living area
 battery 75
 Battery selector switch 80
 Beds 55
 Before the journey 17
 Blind, cleaning 121
 Boiler
 Emptying 98
 Frost protection, switching on 97
 Maintenance 132
 Switching off 97
 Switching on 97
 Brakes 36
 Check 36, 143
 Braking system, troubleshooting 143
 Breakdown services in Europe 155
 Bulb see Illuminant, changing 132
 Bunk bed in the rear 58
 Butane gas 15, 66
- C**
- Cabin black-out shade
 Closing 48
 Opening 48
 Cable reel 85
 Camping gas bottles, use 16, 67
 Camping in winter 157
 Capacity of the battery 74
 Caravan coupling 27
 With detachable ball neck 27
 Care 117
 Blind 121
 Carpet 121
 Curtains 121
 Elevating roof 120
 Entrance step 119
 External care 117
 Furniture surfaces 121
 Gas cooker 121
 High-pressure cleaner, washing with 117
 In the winter 124
 Insect screen 121
 Interior care 120
 Lamps 121
 Net curtains 121
 PVC-floor covering 121
 Roman shade 121
 Seat belt 121
 Sink 121
 Stainless steel surfaces 122
 Synthetic parts, interior 121
 Temporary lay-up 125
 Underbody 119
 Upholstery 121
 Washing 118
 Waste water tank 124
 Water pipes 123
 Water system 123
 Water tank 123
 Windows 118
 Winter lay-up 127
 Carpet, cleaning 121
 Changing wheels 137
 Tightening torque 139
 Checklist
 Before the journey 31
 For the journey 158
 Initial start-up after temporary lay-up 128
 Road safety 31
 Temporary lay-up 126
 Winter lay-up 127
-

Index

Checks see checklist	31, 126
Child restraint systems.....	37
Circulation fan	92
Cleaning see care	117
Cleaning, water tank	123
Closed circuit current	73
Condensation	45
Condensation on the double acrylic glass pane	45
Condensation on the screwed connections in the floor	45
Connecting cable see 230 V connection	85
Conventional load	20
Conversion door.....	43
Insect screen	43
Curtains, cleaning	121

D

Danger of suffocation.....	12, 45
Dealers.....	135
Dimensions see technical data	8
Disclaimer	5
Disposal	
Household waste	9
Sewage	9
Waste water	9
Doors	
Conversion door	43
Troubleshooting	151
Drinking water filler neck.....	106
Closing	106
Opening	106
Driver's seat	39
Driving.....	35
Driving speed	35
Danger for add-on parts.....	36

E

Electrical system	
230 V connection, troubleshooting	143
Explanation of terms	73
Lighting, troubleshooting.....	143
Safety instructions	16
Troubleshooting	143
Elevating roof	59
Cleaning.....	120
Impregnating.....	120
Entrance step.....	28, 41
Care	119
Cleaning.....	119
Extending.....	28
Retracting.....	28
Warning tone	28
Environmental tips	9

Exterior lighting	
Check	31
Illuminant, changing	132
Troubleshooting	143
External care	117
External connection see 230 V connection	41
External flaps.....	44
Flap lock	44

F

Fault current protection switch	85
Check	89
Filling the tank	39
Fire	
Extinguishing.....	11
Response to	11
Fire prevention	11
Fire risks, avoidance	11
FI-switch see fault current protection switch	89
Flat screen	
Driving position.....	55
Storing.....	30
Television position.....	54
Fluorescent tube	
Inserting.....	53
Removing	53
Turning	53
Forced ventilation	12, 45
Front passenger's seat.....	39
Fuel filler neck	39
Furniture flaps, troubleshooting.....	151
Furniture surfaces, cleaning.....	121
Fuse box.....	89
Fuses	
12 V fuses	87
230 V fuse	85, 89
For plus signal.....	88
For Thetford toilet.....	89
On the living area battery	88
On the starter battery	87
Fuses see 12 V fuses and 230 V fuse	87

G

Gas bottle compartment.....	15, 66
Gas bottles	
Changing	69, 71
Safety	66
Safety instructions.....	15
Gas cooker	
Cleaning	121
Switching off.....	100
Switching on.....	100
Troubleshooting	147

-
- Gas isolator tap 72
 Closing 72
 Opening 72
 Symbols 72, 91
 Gas odour 14, 65, 146
 Gas pressure regulator, screw connections 67
 Gas regulator 30
 Gas supply in European countries 156
 Gas system
 Defect 14, 65, 146
 DuoControl 67
 Gas bottles, changing 67
 General instructions 14
 No gas 146
 Operation 67
 Switching automatics 67
 Troubleshooting 146
 General instructions 8
- H**
- Handbrake 41
 Applying 12
 Handling of tyres 139
 Headrests 39
 Heater 91, 95
 Air outlet nozzles, adjustment 92
 Circulation fan 92
 Hot air distribution 92
 Initial start-up 92
 Operating modes 93
 Troubleshooting 147
 Heater safety/drainage valve 94
 Heki skylight 50
 Closing 50
 Insect screen 51
 Opening 50
 Roman shade 51
 Ventilation position 50
 Help on Europe's roads 155
 High rate of gas consumption 14, 65, 146
 High-pressure cleaner, washing with 117
 Hinged window 46
 Closing 46
 Continuous ventilation 46
 Insect screen 47
 Opening 46
 Roman shade 47
 Hot air distribution 92
 Hot-air heater
 Circulation fan 92
 Troubleshooting 147
- I**
- Illuminant, changing 133
 Exterior lighting 132
 Interior lighting 133
 Independent vehicle heater
 Base vehicle, heating 96
 Switching on 96
 Information stickers 135
 Initial start-up 17
 Inner door, troubleshooting 151
 Insect screen, cleaning 121
 Insect screen, conversion door
 Closing 43
 Opening 43
 Insect screen, Heki skylight
 Closing 51
 Opening 51
 Insect screen, window
 Closing 47
 Opening 47
 Inspection time limits 129
 Inspection work 130
 Inspections 130
 Inspections, official 129
 Interior care 120
 Interior lighting 52
 Illuminant, changing 133
 Interior lighting, troubleshooting 143
 ISOFIX child safety seat mounting system 38
- L**
- Lamp in the rear area 54
 Lamps 52, 133
 Cleaning 121
 Operating 52
 Lay-up
 During winter 127
 Temporary 125
 Temporary (toilet) 115
 Leakage water inside the vehicle 150
 Lighting
 Illuminant, changing 132
 Lamps, cleaning 121
 Rear, outside 132
 Troubleshooting 143
 Lights see illuminant, changing 133
 Living area battery
 Charging booster 78
 Discharging 75
 Fuses 88
 Notes for 75
 Position 75
 Troubleshooting 144, 145
-

Index

Load	22
Rear storage space	26
Load see also payload	22
Lock	
Doors	43
External flap	44
Longitudinal rear beds	55

M

Maintenance work	130
Mass in running order	19

N

Net curtains, cleaning	121
Nose weight	27

O

Official inspections	129
Off-load voltage	73
Operating modes	
Heater	93
Production of hot water	93
Optional equipment	20
Certification	7
Description	7
Safety instructions	12
Oven see gas cooker or gas oven	99
Overloading	22

P

Panel (LT 100)	82
12 V main switch	82
Partition wall, removable	29
Payload	18
Permissible gross weight see technically permissible maximum laden mass	17
Personal equipment	20
Position	
Battery selector switch	80
Fuse box	89
Living area battery	75
Water pump	105
Production of hot water	91, 95
Emptying	95
Operating modes	93
Safety/drainage valve	94
Switching off	94
Switching on	93, 94
Troubleshooting	147
Water, filling with	95
Propane gas	15, 66
PVC-floor covering	52
PVC-floor covering, cleaning	121

R

Ramps	41
Rear axle load	27
Rear bed	
Conversion after sleeping	55
Conversion for sleeping	55
Rear doors	44
Rear lights	132
Refrigerator	41, 101
Door lock	103
Night mode, switching off	102
Night mode, switching on	102
Switching off	102
Switching on	102
Temperature, adjusting	102
Troubleshooting	149
Refrigerator door	
Closing	103
Locking in the ventilation position	103
Opening	103
Risk of frost damage	105, 109
Road safety	31
Checklist	31
Notes for	12
Roman shade, cleaning	121
Roman shade, Heki skylight	
Closing	51
Opening	51
Roman shade, window	
Closing	47
Opening	47

S

Safety cut-out	89
Safety instructions	11
Electrical system	16
Fire prevention	11
Road safety	12
Towing	14
Water system	16
Sanitary fittings	105
Screen	
Closing	48
Opening	48
Screen holder	
Driving position	55
Television position	54
Seat belts	36
Cleaning	121
Correct fastening	37
Seating arrangement	39
Seating group, sleeping conversion	59
Serial number	134
Servicing work	130
Set of keys	17

-
- Sewage tank
 Emptying 114
 Removal 114
Sewage tank see toilet cassette 114
Shower 112
Sink, cleaning 121
Skylight with snap latch 49
 Closing 49
 Opening 49
Skylights 48
 Heki skylight 50
 Skylight with snap latch 49
Snow chains 31
Spare parts 134
Spotlight 52
 Removing 53
 Shifting 53
 Turning 53
Stainless steel surface, cleaning 122
Starter battery
 Fuses 87
 Loading 76
 Troubleshooting 144
Start-up
 After a temporary lay-up 128
 After a winter lay-up 128
Staying overnight, during travel 157
Suspension table
 Conversion into bed foundation 52
 Extending 51
 Reducing size 51
 With separable support leg 51
Symbols
 For notes 7
 Gas isolator taps 72, 91
Synthetic parts in the toilet and living areas,
cleaning 121
- T**
- Tables 51
Tank lid see fuel filler neck 39
Technical data 8
Technically permissible maximum laden
mass 18, 21
Tightening torque, wheels 139
Toilet 113
 Flushing 113
 Fuse 89
 Level indicator 113
 Temporary lay-up 115
 Troubleshooting 150
 Winter operation 115
Toilet cassette, retaining clip 114
Toilet compartment 112
 Ventilation 112
Toll regulations in European countries 156
- Total discharge 73
Towing 14
 General instructions 27
 Safety instructions 14
Traffic rules in foreign countries 155
Transformer/rectifier (EBL 31) 79
 Functions 80
 Position 79
Transverse rear bed 55
Travel checklists 158
Troubleshooting
 12 V power supply 145
 230 V connection 143
 Battery 144
 Body 151
 Braking system 143
 Electrical system 143
 Extractor hood 147
 Furniture flaps 151
 Gas cooker 147
 Gas system 146
 Hot-air heater 147
 Inner door 151
 Lighting 143
 Living area battery 144
 Production of hot water 147
 Refrigerator 149
 Starter battery 144
 Toilet 150
 Water supply 150
TV unit 54
Tyre specifications 139
Tyres
 Certification 139
 Excessive wear 13, 31, 137, 140
 General instructions 137
 Handling 139
 Tyre pressure 140
 Tyre selection 138
- U**
- Underbody, maintenance 119
Upholstery, cleaning 121
USB socket element 53
- V**
- Vehicle identification plate 134
Vehicle lighting see exterior lighting 132
Vehicle load capacity 17
 Calculation 21
 Composition 19
Vehicle load capacity see also load 17
Vehicle, washing 118
Ventilation 45
 Toilet compartment 112
-

Index

W

Warning stickers	135	Disinfect.....	124
Warranty certificate	5	Drinking water filler neck.....	106
Washing with a high-pressure cleaner.....	117	Emptying	109
Waste water tank	110	Filling	107
Care	124	Safety instructions.....	16
Emptying.....	111	Water tank	
Troubleshooting	150	Cleaning	123
Waste water tank, heated and insulated.....	111	Water quantity, reducing	108
Waste water tap.....	111	Water, draining.....	109
Water pipes, cleaning	123	Water, filling with	108
Water pump	105, 107	Water tank see also water system	106
Water supply		Wheel rim type	137
General	105	Windows.....	45
Troubleshooting	150	Insect screen.....	47
Water system		Roman shade.....	47
Care	123	Windows, cleaning	118
Cleaning.....	123	Winter care	124
		Winter operation	125

LMC CARAVAN GMBH & CO. KG Rudolf-Diesel-Straße 4 D-48336 Sassenberg

T +49(0)2583/27-0 **E** info@lmc-caravan.de **H** www.lmc-caravan.de

Münster (Westf.): HRB 9914 USt-IdNr. 126 733 941 Geschäftsführer: Bodo Diller, Timo Ecke, René Ricken