

LMC

BEDIENUNGSANLEITUNG **TOURER ALKOVEN**

OPERATING MANUAL

GEBRUIKERSHANDLEIDING

MANUEL D'UTILISATION

MANUAL DE INSTRUCCIONES

ISTRUZIONI D'USO

BRUGSANVISNING

KÄYTTÖOHJEET

KULLANIM KILAVUZU

操作说明

**Travelling in comfort -
your home on four wheels**

Dear motor home enthusiasts!

Congratulations on the purchase of your new LMC motor home!
You have purchased a high-quality, reliable and elegant vehicle
that offers special advantages and extraordinary comfort.

Our employees extend their best wishes for your satisfaction
when travelling, on holiday, or in your free-time; we are confident
that you will always enjoy pleasant hours in your new home on
wheels!

“Please also observe the chassis manufacturer’s operating
instructions at all times.” “The terms used in these operating
instructions with regard to weight specifications are explained
again in detail at the end of the operating instructions (legal
information on weight-related specifications). For further details
on weight specifications, please also refer to the “Weight
information” section of our homepage at [www.lmc-
caravan.com/de/de/gewichtsinformationen](http://www.lmc-caravan.com/de/de/gewichtsinformationen).”

© LMC Caravan GmbH & Co. KG
Rudolf-Diesel-Str. 4
D-48336 Sassenberg

Tel.: +49 25 83 / 27-0
Fax: +49 25 83 / 27- 138

E-mail: info@lmc-caravan.de
Internet: www.lmc-caravan.com

Issue: 18.04.2024

Art. No. 3590676

Created by: gds GmbH
global document solutions
www.gds.eu

1	Introduction.....	7
1.1	Technical documentation	8
1.2	Explanation of symbols used	9
1.3	Vehicle registration.....	11
1.4	Keys	12
2	Safety.....	13
2.1	Intended use.....	13
2.2	Responsibility of the vehicle owner	14
2.3	General requirements	15
2.4	Fire safety.....	16
2.5	Traffic safety.....	17
	2.5.1 General	17
	2.5.2 Driving	22
2.6	Operational reliability.....	25
	2.6.1 Gas supply	25
	2.6.2 Electrical system	27
	2.6.3 Sanitary system	29
2.7	Environmental protection	31
3	Technical data.....	32
3.1	Nameplate	32
3.2	Weight specifications, load distribution and load securing	33
	3.2.1 Technically permissible mass	33
	3.2.2 Actual weighed mass of your vehicle and remaining load capacity	34
	3.2.3 Technically permissible mass on the axle (mass on the axle).....	36
	3.2.4 Increase in load capacity and reduction in load capacity	37
	3.2.5 Load distribution and load securing	39
	3.2.6 Rear garage and rear storage space (model-dependent)	41
3.3	Built-in devices	43
3.4	Fuses and fuse plug-ins	43
	3.4.1 230 V input and main fuse	43
	3.4.2 12 V fuses in the motorhome	45
	3.4.3 Additional plug-in fuse slots	49
4	Driving	50
	4.1.1 Reviewing the check list.....	52
4.2	Checking the vehicle	52
4.3	Fuelling.....	54
4.4	Starting your journey	55
	4.4.1 Entering	55
4.5	Travelling and parking.....	57
4.6	Parking the motor home at the destination	59

4.6.1	Parking the motor home	59
4.6.2	Extending the rear support.....	60
4.6.3	Retracting the rear support	61
5	Overview	62
5.1	Caravan body	63
5.1.1	Keys for the motorhome.....	63
5.1.2	Entrance door.....	63
5.1.3	Door and hatch locks	66
5.1.3.1	"THULE Excellent" (optional) bicycle carrier	68
5.1.4	Hinged window	69
5.1.5	Combination blinds.....	71
5.1.6	Driver cab curtain	72
5.1.7	Air conditioning system (optional).....	72
5.1.8	Skylights	73
5.1.9	Light in the entrance area	74
5.1.10	Exhibition lighting (optional)	74
5.1.11	LED switches and LED displays (optional)	75
5.1.12	Smoke detector (optional).....	76
5.2	Furnishings	76
5.2.1	Seating and sleeping area	77
5.2.2	Bathroom.....	78
5.2.3	Kitchen area	80
5.3	Storage compartments	82
5.3.1	Rear external storage locker.....	82
5.3.2	Wall cupboards	83
5.3.3	TV bracket.....	84
5.4	Technical equipment	85
5.4.1	Electrical system	85
5.4.1.1	Supply battery	86
5.4.1.2	Lay-up.....	89
5.4.1.3	Operating and control panel LT 460 A.....	90
5.4.1.4	Interior lighting	93
5.4.1.5	Power outlets	95
5.4.2	Gas supply	96
5.4.3	Heater 99	
5.4.3.1	TRUMA Combi-D heater (optional).....	99
5.4.3.2	Heat the floor with hot water (optional).....	103
5.4.4	Fresh water and waste water system	104
5.4.4.1	Fresh water tank	104
5.4.4.2	Waste water tank	105
5.4.4.3	Drain valves for fresh water and waste water system ..	105

6	Camping	106
6.1	Equipping the camper	106
6.1.1	Establishing the power connection	106
6.1.2	Filling the fresh water tank	106
6.1.3	Drawing fresh water	108
6.1.4	Emptying the fresh water tank	108
6.1.5	Emptying the waste water tank	111
6.1.6	Changing the gas bottle	112
6.1.7	Gas supply maintenance (general)	113
6.2	Airing	114
6.3	Heating and water heating	118
6.3.1.1	TRUMA Combi-D heater (optional)	118
6.3.2	Heating the floor with hot water using the Truma Combi heater	131
6.3.3	Water heater	131
6.3.3.1	Applicable if the TRUMA combination heater is installed	132
6.4	Sitting and sleeping	133
6.4.1	Bistro table with table extension	133
6.4.2	Fold-out seat pan as bed extension	135
6.4.3	Converting the sitting area into berths	136
6.4.4	How to set up a berth	137
6.4.5	Folding and unfolding the bed in the alcove	138
6.4.6	Setting up the lighting	139
6.5	Bathroom	141
6.5.1	How to use the shower	141
6.5.2	How to use the wash basin	141
6.5.3	Flushing the toilet with revolving toilets (optional)	141
6.5.4	Emptying the waste holding tank	142
6.6	Kitchen area	143
6.6.1	Using the combination hob including fitted sink	143
6.6.2	Using the oven with grill function (optional)	146
6.6.3	12 V compressor refrigerator (option)	148
6.6.4	Refrigerator for 12 V operation (option)	150
7	Maintenance	152
7.1	Exterior cleaning	153
7.2	Interior cleaning	154
7.3	Preparing the caravan for periods of non-use	155
8	Maintenance and inspection	157
8.1	Maintenance schedule	158
8.2	Inspection schedule	159
8.3	Changing wheels	159

9	Malfunctions.....	160
9.1	Caravan body	160
9.2	Electrical system.....	161
9.2.1	Alarms Operating and control panel LT 460 A.....	164
9.2.2	Changing light bulbs.....	165
9.2.3	Changing the smoke detector (optional) battery	170
9.3	Gas supply.....	171
9.4	Hob	171
9.5	Heater and hot water	172
9.5.1	Malfunctions, TRUMA heater	172
9.6	Refrigerator.....	173
9.7	Fresh water and waste water system.....	174
10	Tightness guarantee.....	176
10.1	Guarantee certificate	176
10.2	Guarantee conditions and terms	176
10.3	Inspection schedule and inspection certificates	179
10.3.1	Overview of the extent of the leak inspections.....	179
11	Appendix.....	181
	Legal notes on weight-related information.....	181
	Interior and exterior material care.....	185
12	Index	188

1 Introduction

Before the first trip

Your dealer will provide extensive instruction in all important functions when your vehicle is transferred to you so that you can properly operate and use your vehicle at any time.

In addition, this operating manual provides important information for using the vehicle and equipment. Carefully read this operating manual prior to using your caravan for the first time. Always comply with the instructions and safety instructions contained in this operating manual!

Strictly comply with the instructions in the accompanying operating manuals provided by the manufacturers of the built-in devices!

In an emergency situation: Help...!

If there are questions about operation, care, maintenance or repair, you can contact your nearest authorised dealer with confidence. You can find an overview of the dealers with their addresses on our homepage under the heading "Dealer search".

The dealers know your vehicle and are familiar with our latest innovations and they can provide prompt and expert assistance.

Introduction

1.1 Technical documentation

The following vehicle documents are in the document case:

Manufacturer documentation

- Operating manual with inspection booklet for leakage warranty

Supplemental documents

- Documents from the chassis manufacturer
- Device operating manual for cooker
- Device operating manual for refrigerator
- Device operating manual for heater
- Device operating manual for toilet
- Device operating manual for optional equipment
- Test certificate for the gas system with inspection tag (through the dealer)

Topicality

We continuously work on further enhancing the performance characteristics of our motor homes. Thus we reserve the right to make changes in shape, equipment and technology on the vehicle compared to the information provided in this operating manual. Descriptions are for the equipment known and installed at the time this manual went to press. Consequently, no claims against the manufacturer can be derived based on the content of this manual.

Retention

The operating manual and all accompanying documents concerning the vehicle and the installed devices are considered to be a fixed component of your vehicle. They must always be accessible to all users.

Keep this operating manual and associated documents on hand in the vehicle.

Transfer all documents to the next owner if the vehicle is sold. If loaning the vehicle to a third party provide the documents to the user.

1.2 Explanation of symbols used

Safety and warning signs

Important instructions are especially marked by symbols and signal term. Comply exactly with the specified instructions to prevent personal injury, material damage and environmental damage.

DANGER



Danger to life and/or severe damage to health

This symbol combined with the "DANGER" signal term identifies an immediate hazard resulting in death or severe (irreversible) injuries.

WARNING



Severe damage to health

This symbol combined with the "WARNING" signal term identifies an imminent hazard potentially resulting in death or severe (irreversible) injuries.

CAUTION



Damage to health

This symbol combined with the "CAUTION" signal term identifies a hazard potentially resulting in slight (reversible) injuries.

CAUTION



Damage to property

This symbol combined with the "ATTENTION" signal term identifies a situation that may cause to damages to the product or objects in its vicinity.

Introduction

Tips and recommendations

NOTE



This symbol combined with the "NOTE" signal term identifies useful tips and recommendations for the efficient handling of the vehicle and its equipment.

Environmental protection

NOTE



This symbol combined with the "NOTE" signal term identifies important information regarding an environmentally conscious behaviour.

Directions

The "right", "left", "front", and "rear" directions always refer to the view in driving direction.

Dimensions and weights are rounded ("approximate" information).

Motor home, vehicle

Refers to the entire vehicle from the front to the rear lights. It consists of a chassis and a superstructure.

Motor home body

Refers to the superstructure mounted onto the chassis, including all systems and furnishings; however, it does not include the driver's cab.

Optional equipment

All optional equipment parts not included in the standard equipment which are fitted to the vehicle under the responsibility of the manufacturer.

The optional equipment is only included in the document if selected and is marked "optional".

Always refer to the supplemental documents.

1.3 Vehicle registration

Obligation to register

Pursuant to applicable national regulations, your vehicle must be registered with the relevant authority. Registration is issued by the vehicle licensing organization of your local government.

Required documents

For registration you require:

- Registration certificate part I (vehicle registration certificate)
- Registration certificate part II (vehicle title document)
- COC document (European certificate of conformity)
- Insurance verification
- Proof of roadworthiness (depending on the rules and regulations of the country of use)
- ID card or passport
- Registration authority (if registered by a third party)
- Registration application if required

The registration certificate (if applicable in the country of use) also serves as the holder's verification of ownership. Do not keep the certificate inside the vehicle!

The vehicle documents (registration certificate part I, insurance slip and MOT certificate) are considered to be the proof of authorisation for the use of the vehicle and must be carried while using the vehicle. Never store any vehicle documents inside the vehicle!

Registration plate

Brackets are provided at the rear and front of the vehicle for attachment of the registration plate.

Note that in some countries, in addition to the country code shown on the license plate, a separate nationality tag is also mandatory.

Introduction

1.4 Keys

Vehicle key

During the handover of the vehicle, you receive:

- Two ignition keys to start the vehicle and to open and close the driver and front passenger doors
- You may also receive a key for the petrol cap cover

Depending on the manufacturer of the chassis, the ignition key or a separate key is used to operate the petrol cap cover.

Alternatively, the petrol cap cover may be opened and closed by locking and unlocking the driver door.

Key for the caravan body

Two additional keys are provided for:

- Entrance door to the caravan body
- The freshwater tank (if the water intake port is located on the outside)
- Toilet compartment
- Gas locker
- Service door or external storage locker door (if applicable)

2 Safety

This section lists all the important safety aspects for optimal protection of persons in the vehicle, and for safe and trouble-free use of the furnishings.

Moreover, the following sections include additional safety instructions for avoiding imminent dangers when using devices and equipment.

Always comply with the handling instructions specified and keep the pictograms, signs, and texts that are affixed to the built-in equipment in a legible condition.

2.1 Intended use

The motor home is designed exclusively for the conveyance of passengers and to transport luggage. It can be used in public traffic in accordance with the provisions of the Road Traffic Act and the Road Traffic Registration Act of the country in which the vehicle is operated.

The motor home must not be used for commercial transport of persons and/or goods.

Transporting unsecured loads and/or packed goods that are not used as luggage is not permitted.

Each person travelling along in vehicle must be wearing a safety belt while occupying their respective seats. The number of persons travelling in the vehicle must not exceed the number of seats equipped with safety belts.

The mass in a driving-ready state and technically permissible mass on each axle must not be exceeded.

Any use of the motor home contrary to the application described herein is prohibited and is considered to be improper use.

2.2 Responsibility of the vehicle owner

The vehicle has been designed and built in accordance with state of the art and in accordance with recognised safety-related rules.

Nevertheless if the instructions in the operating manual are not followed serious personal injury, significant material damage to or on the vehicle or environmental damage can occur.

Consequently the vehicle owner is obligated:

- To always keep the vehicle in technically faultless and road-safe condition.
- To exactly follow the instructions in the operating manual, and to ensure that all passengers comply with the instructions contained in the operating manual.
- To comply with the specified service intervals and to ensure that the legally prescribed tests and inspections are executed.
- To have the gas supply regularly inspected by an authorised service operation pursuant to applicable regulations.
- Not to make any unauthorised modifications to the vehicle or to the caravan body.
- To have technical problems that may adversely affect the safety of people and/or public road transport to be remedied immediately by specialist personnel.
- To always act in an environmentally responsible manner.
- To stay informed of current regulations and laws that can contain additional obligations.

2.3 General requirements

For your own safety and the safety of your passengers always comply with the following instructions:

- Travel with the motorhome only when it is technically sound and fully roadworthy!
 - Prior to every journey, the technical condition of the vehicle must be inspected.
 - Always comply with the operating instructions and traffic regulations.
- Always secure the vehicle when parking and leaving!
 - Engage the parking brake.
 - Lock all doors, hatches and windows.
- Ensure the vehicle is always efficiently ventilated!
 - Never cover forced ventilation openings.
 - Thoroughly ventilate the living area when cooking or heating.
- Careful around doors and hatches!
 - Mind the door heights when entering and exiting the vehicle, and while cleaning and carrying out maintenance work.
 - Exercise caution when using doors and hatches. There is a risk of crushing and bruising injuries.
- Accidents do happen; therefore, always be prepared!
 - Always keep warning triangles and first aid kits easily accessible.
 - All vehicles exceeding a total weight of 3.5 t must carry hazard warning flashers and use them in an emergency.

Safety

2.4 Fire safety**Avoid fire and fire propagation!**

- Always keep the smoke alarm, located in the ceiling of the caravan body, in functional condition.
 - Prior to using the vehicle for the first time, remove the protective foil from the block battery in the smoke alarm and connect the block battery to activate the smoke alarm.
 - Do not hook things into the openings on the smoke alarm housing, or cover the openings on the housing.
 - Replace the battery installed in the smoke alarm on a regular basis.
 - Replace the installed smoke alarm with a new smoke alarm every 10 years at the latest.
- Always carry an approved and tested dry-powder fire extinguisher (at least 1 kg) in the vehicle (not included in the scope of delivery).
- Always keep fire extinguisher in reach and have it tested regularly. Be aware of the test date.

Avoid fire hazards!

- Never leave children alone in the vehicle.
- Keep flammable materials away from the heater and hob.
- Never use portable heating and cooking devices.
- Never cover electrical components that can develop heat during operation (e.g. charger, electric block, lights).
- Never modify the electrical equipment or to the liquid petroleum gas (LPG) system. Have all repairs performed by qualified personnel.

Act appropriately if there is a fire!

If the smoke alarm trips or if you detect signs of a fire in the vehicle:

- Evacuate vehicle passengers without delay. If necessary provide first-aid.
- Switch off the power supply and disconnect it from the mains.
- Close the gas bottle valves.
- Secure the danger zone around the vehicle.
- Sound the alarm and call the fire department.
- Fight the fire, if this is possible without danger.

2.5 Traffic safety

Driving in public traffic always demands special caution and attentiveness. Always comply with locally applicable traffic regulations, the operating guidelines for the vehicle and the following instructions!

2.5.1 General

About the base vehicle

The base vehicle is a large-sized, commercial vehicle (small lorry) with a high technically permissible mass. Incorrect behaviour can result in accidents with serious or fatal injury as a consequence.

Always adjust your manner of driving and comply with the following instructions:

- Do not exceed the technically permissible mass.
- Compared to your car, the motor home has a longer braking distance.
- Prior to driving into a car park, underpasses, bridges, tunnels, or vehicle decks of ferries, note the clearance dimensions such as height and width.
- Comply with local driving restrictions or special driving instructions for motor homes.
- Loading can change the handling and road holding of the motor home.
- If the total weight of the motor home exceeds 4 t, wheel chocks must be carried in the vehicle. They must be used when parking on up- and downhill-slopes.

Safety

WARNING



The exterior-mounted optional equipment fitted by LMC can limit the maximum speed. Please take this into account in order not to endanger other road users. Please see the attached table for the recommended maximum speeds for the exterior optional equipment.

WARNING



Recommended maximum speed

Code	km/h
Skylight, 400 x 400 mm	160 km/h
Skylight, 280 x 280 mm	160 km/h
Skylight, 700 x 500 mm	160 km/h
Air-conditioning	120 km/h
SAT system	130 km/h

Wheels and tyres

Worn tyres and incorrect tyre pressures adversely affect the driving and braking behaviour of the vehicle and can cause accidents.

Always ensure that:

- Rims and tyres must be approved for the vehicle (→ motor vehicle registration certificate part I).
- Regularly (during every refuelling stop, for example) check the proper condition and correct tyre pressure of the vehicle (→ Section "Tyre pressure table")
- Immediately replace worn tyres.
- For the first trip, after every wheel fitting, and after every wheel change, re-tighten the lug nuts after 50 km (30 miles).
- During longer trips, check the lug nuts for firm seat at regular intervals.
- Tyres must not be older than six years. The same applies for spare tyres - even if they have not been used.
- Use summer tyres or snow tyres in accordance with the outdoor temperatures in the country of travel.
- Depending on the tyres, comply with the specified tread regulations.
- Prior to a longer parking period, offload the tyres (e.g. jack up the vehicle, dismount the wheels, apply a preserving agent to the tyres and store them horizontally or on a wheel tree in a dry and frost-free location).

Snow chains

- When using snow chains, compliance with local rules and regulations is mandatory.
- Only install the snow chains to the drive wheels. Compliance with the manufacturer instructions is mandatory. After driving several meters, stop and inspect the snow chains for proper fit and tension.
- When snow chains are installed, always drive slowly and travel only on snow-covered roads.

Safety

Brakes

Defects in the braking system can cause serious accidents with fatal consequences.

Always ensure that:

- Prior to each journey check the functional safety of the brakes, uniform response, and directional stability. Have any defects repaired immediately by an authorised specialised workshop.
- Never make unauthorised changes to brake system components.
- Check the filling level of the brake fluid regularly and top up if necessary. Compliance with the manufacturer's instructions of the base vehicle is mandatory.
- Always engage the parking brake when parking the vehicle.
- After a longer period of non-use (≥ 10 months), have the brake system checked by an authorised workshop.

Trailer

There is an inherent risk when attempting to hitch a trailer.

Always ensure that:

- The base vehicle is equipped with a functionally safe trailer pulling device and an electrical connector coupling.
- The trailer must be in an operationally safe condition, have a valid licence, and be configured for the base vehicle. Do not exceed the technically permissible trailer load and maximum drawbar load (\rightarrow registration certificate part I, operating manuals for the towing vehicle and the towing device).
- If the trailer is equipped with an over-run brake system and the brake is seized, do not hitch or unhitch the trailer.
- When using couplings with a removable hitch ball, ensure that the hitch ball is properly mounted (\rightarrow operating manual provided with the towing device).
- Always proceed with caution during the coupling procedure.
- Use an assistant to help the driver of the towing vehicle.
- Ensure that no one is in the motor home and that no one is in the space between towing vehicle and caravan.
- Only enter the zone between the towing vehicle and the trailer if both cannot move and the parking brake is engaged.
- Immediately after hitching the vehicle and the trailer, check the vehicle's lighting equipment on the trailer and test the brakes for proper function.

Vehicle equipment

Mandatory equipment

When travelling abroad, ensure that you check the national and regional regulations of the transit countries and the destination; if necessary, the required equipment must be added.

- The first aid kit must not be older than 5 years (note the expiration date on the package)
- Warning triangle
- High-visibility vest
- Hazard warning lamps (if total permissible vehicle weight exceeds 3.5 t)
- At least 2 wheel chokes, (if total permissible vehicle weight exceeds 4 t)

Recommended accessories

- 2 Gas bottles, filled (11 kg or 5 kg)
- 1 Water canister with spout attachment or watering can
- CEE connector cable for external 230-V connection
- Adapter set for external power supply
- Cable drum (25 m)

Vehicle equipment

Mandatory equipment

When travelling abroad, ensure that you check the national and regional regulations of the transit countries and the destination; if necessary, the required equipment must be added.

- The first aid kit must not be older than 5 years (note the expiration date on the package)
- Warning triangle
- High-visibility vest
- Hazard warning lamps (if total permissible vehicle weight exceeds 3.5 t)
- At least 2 wheel chokes, (if total permissible vehicle weight exceeds 4 t)

Recommended accessories

- One gas bottles, filled (11 kg)
- 1 water canister with spout attachment or watering can
- CEE connector cable for external 230-V connection
- Adapter set for external power supply
- Cable drum (25 m)

Safety

2.5.2 Driving**Before the trip**

Unsecured load, a vehicle in a condition that is not ready to drive and/or technical defects can cause accidents with severe or fatal injuries.

Before starting your trip, always perform the following tasks:

- Remove any branches, twigs, leaves, snow or ice from the vehicle roof.
- Check that the entry step is retracted.
- Check the functioning of signalling and lighting equipment.
- Switch off the canopy light on the right side wall.
- Ensure faultless functioning of brakes and steering gear.
- Check rims and tyre tread for proper condition. Ensure that the tyres are inflated to the proper pressure.
- Securely stow luggage and loose objects. Also ensure that the load is uniformly distributed in the vehicle.
- Close and secure all inner and outer doors, service hatches, windows and skylights.
- Close and secure the pop-up top, if fitted.
- If fitted, move the lift-up bed into the top position (travel position).
- In the living area, close and secure cabinets, refrigerator doors and cover panels for the hob and sink.
- Lock adjustable tables and beds.
- If available, push the TV drawer back and secure. Close the hatch of the TV compartment or secure the TV drawer so that it cannot twist.
- Switch the refrigerator to internal 12 V power supply.
- Close the quick-action valves and the gas bottle valve.
- Remove the wheel chocks and retract the vehicle supports.
- Before driving, fold down the alcove bed.
- Retract the entrance step.
- Lock all swivel/rotary seats in the direction of travel.
- Completely open and secure the blinds on the windscreen and on the driver and passenger windows.
- Place children into specified, approved child seats according to the child's age and height.
- All passengers must wear their seatbelts while travelling.

Fuelling

Fuel can cause severe health hazards, it is highly inflammable and may lead to injuries or may cause damage to the environment and result in physical damage.

Always ensure that:

- the petrol system is switched off prior to fuelling. Close all petrol appliances, quick-action valves and gas cylinder valves.
- Never confuse the fuel filler cap with the fresh water inlet! Only a few drops of fuel will contaminate the entire fresh water system.
- Any fuel spillage must be wiped up immediately and disposed of.

En route

Failure to comply with local traffic regulations can cause accidents with serious or fatal injuries.

While en route, the following instructions must be observed:

- Always comply with local traffic regulations.
- Always adjust your driving to current road and traffic conditions, the total weight and dimensions of your vehicle.
- In particular, compliance with driving restrictions for motor homes is mandatory.
- Prior to driving into a car park, underpasses, bridges, tunnels, or vehicle decks of ferries, note the clearance dimensions such as height and width.
- The number of persons travelling in the vehicle must not exceed the permitted maximum number of passengers (→ see vehicle registration document).
- While driving the vehicle, all passengers must wear their seatbelts.
- Never open door locks while driving.
- Avoid sudden and abrupt braking.
- Drive slowly and carefully if the road conditions are poor.
- Avoid bottoming out on ramps (when entering a ferry, for example), uneven surfaces, or when driving in reverse.

Safety

Parking and stopping

Unsecured vehicles can roll away and cause serious injury and material damage.

When parking, the following instructions must be observed:

- Never park or stop the motor home on hillsides, embankments, up- or down-hill slopes.
- If you must park or stop the motor home on an incline, turn off the engine, engage the first gear and apply the parking brake. Subsequently, place the wheel chokes under the wheels (mandatory for vehicles with a permissible total weight of 4 t).
- On slight embankments, inclines, or slopes, place wheel chocks in front of and behind one or more wheels. Secure the wheels through the curved stop surface of the wheel chocks.
- Do not use wheel chocks to compensate for uneven terrain or roads.
- Extend the jacks when parking the motor home for some time.
- When retracting or extending the entrance step, ensure that no person is standing on the step.
- In winter conditions, free the vehicle of the snow and ice load. Do not exceed the permissible roof load of 75 kg.

2.6 Operational reliability

2.6.1 Gas supply

General

The gas supply system was installed, inspected and accepted according to DIN EN 1949 and a pressure and tightness was completed according to the German Association for Gas and Water DVGW worksheet G 607. Any modification of the gas supply system after delivery of the vehicle invalidates the enclosed gas test certificate and the inspection tag at your vehicle.

- In addition to the following instructions, always comply with the instructions provided for the built-in gas devices.
- Always carry the operating manuals for the gas devices in the vehicle with easy access for all parties.

Defective gas devices and supply lines may catch fire or explode and cause severe injuries. Escaping gas is a suffocation hazard. Always ensure that:

Test obligation

- Have the gas supply inspected by an authorised specialist workshop at the latest every two years. This also applies for non-licensed vehicles. Comply with local regulations.
- Do not modify the gas supply without proper authorisation. Only an authorised workshop may repair and replace gas devices.
- Regularly check the functioning of the safety pilots. Safety pilots must close the gas supply within one minute after the gas flame is extinguished (audible click).
- Check the gas hose at the pressure regulator whenever the gas bottle is exchanged. The hose should not be porous or scored.
If required, have the gas hose replaced by an authorised workshop.

Safety

Using the gas devices

- Use only tested and intact gas devices and gas bottles (11 kg or 5 kg bottles).
- Open the quick-action valve of a gas device only if the device is to be operated. Valves must be closed when the unit is not in use.
- Before using the hob, all combustible materials such as curtains, towels and clothes must be removed from the danger area.
- Open the skylight before using the gas hob.
- Do not use the hob as a space heater.
- If you smell gas or notice high levels of gas consumption, defects or other irregularities, immediately:
 - Switch off all gas devices
 - Close the main shut-off valve on the gas bottles
 - Do not smoke and do not ignite any flames
 - Do not switch on any lights or other electrical devices
 - Open windows and doors, thoroughly ventilate the interior
- Do not use butane gas for winter operation as it is only capable of gasification to 0 °C. Propane gasifies to minus 42 °C.

Gas bottles, pressure regulators and gas bottle locker

- Only connect gas bottles that are filled with propane or butane, or with a mixture of the two gases.
- Transport gas bottles only in the gas bottle locker.
- Always set up gas bottle locker vertically and strap them securely in place.
- Use only pressure regulators that are permanently set to 30 mbar output pressure.
- Always carefully connect pressure regulators as prescribed:
 - If there is a direct connection without gas pressure regulator set (optional), connect the pressure regulator directly on the gas bottle valve.
 - If you use a gas pressure regulator set (e.g. DuoComfort or SecuMotion, both optional) the pressure regulator must be mounted on the rigid permanent line. In this case, connect the gas bottle valve to the gas pressure regulator using an approved high-pressure gas hose.
- Tighten the pressure regulator or high-pressure gas hose only manually (left-handed thread!). Do not use tools.
- Gas bottle valves must be accessible at any time.
- Do not use gas bottle locker as a storage compartment.
- Never cover the forced ventilation at the gas bottle locker.
- Always secure the gas bottle locker against unauthorised access.

Driving and parking

The gas-operated devices may only be used **if the gas pressure control valve with crash sensor (optional) is installed.**

Otherwise, the following instructions apply:

- Prior to starting a journey, close the gas bottle valve and the quick-action valves of the gas devices.
- Do not operate gas devices when refuelling, on ferries, in garages or car parks. Danger of explosion!
- Prior to longer periods of non-use, close all gas bottle valves and the quick-action valves of all gas devices.
- After a longer period of non-use (≥ 10 months), have an authorised workshop check the gas supply system for tightness and functioning before prior to first use.

2.6.2 Electrical system

General

The vehicle is equipped with a combined power supply system for 230 VAC/12 V. For the connection to an external power supply, you require a three-pole CEE connection cable (see below).

Before travelling to foreign countries, obtain information about the plug and connector systems used at your destination. Adapters are available from specialised dealers.

Touching live components can cause serious or fatal injury. Improper connection or defective electrical devices can cause fires. Always ensure that:

External power connection

- Prior to connecting, ensure that the external power supply matches the specifications of the vehicle's electrical system.
- The external power supply must be protected with a residual current circuit breaker (RCD, 30 mA).
- Use only connecting cable with the following properties:
 - Flexible CEE rubber-sheathed cable for outdoor use
 - Cross-section 3 x 2.5 mm² minimum
 - Plug connector and coupling should each have earthing contact
- Before use, check the connecting cable, plug and coupling for damage.
- The extension cable must not be longer than 25 m.
- When using cable drums, completely unroll the power cable; this prevents the cable from overheating.
- Lay the cable so that it does not cause a stumbling hazard; mark the cable routing, if necessary.

Safety**Electrical system and devices**

- Connect only tested and intact devices.
- Any device exhibiting defects, faults or external damages must be immediately disconnected from the vehicle system.
- Periodic testing by an electrician.
 - Annually for frequent use
 - Every three years for occasional use
 - Half-yearly activation of the RCD test button
- Any work on the system, repairs or replacement of electrical devices must be performed by an authorised workshop only.
- Prior to starting any work on the system, switch off all electrical consumers, such as lights, TV, radio and other devices; disconnect the external power supply and disconnect the supply batteries.
- Check the function of the integrated residual current circuit breaker in the fuse box at regular intervals.
- Never bridge, manipulate or repair any miniature circuit breaker or safety fuse.
- Replace defective fuses only after the cause of the fault has been identified and rectified.
- Replace defective fuses only with new original fuses of the specified amps rating.
- Never cover electrical components that can generate heat during the operation (e.g. Elektroblok). Avoid any heat build-up.

CAUTION

Only allow specialist personnel to work on the electrical system.

All electrical devices (e.g. mobile phones, radios, televisions or DVD players) that are retrofitted to the vehicle and operated while driving must have certain features:

- CE-mark
- EMC-test
- e-test

This is the only way to ensure the functional safety of the vehicle while driving. Otherwise, the airbag may deploy or the on-board electronics may malfunction

2.6.3 Sanitary system

General

As standard, the vehicle is equipped with a fresh water tank, a waste water tank, and a toilet.

WARNING



Health hazards due to chemicals!

Harmful chemical cleaning agents are required for toilet hygiene.

- Comply with the manufacturer's instruction on the packaging and use with caution.

ATTENTION



Damages after extended stand time or frost!

If the vehicle is not used in winter, the sanitary system may be damaged due to frost.

Extended stand times can cause algae growth in the sanitary system.

- Ensure that the overflow valve is free from contamination and ice formation.
- In the event of frost or extended stand time, completely empty the water tanks, containers, hoses, and conduits. Dry-run the pump for approximately five minutes to avoid frost damage caused by residual water in the pump.

NOTE



Waste water, solid waste and chemical substances can cause significant environmental damage.

- *Drain the waste water and solid waste tank only at designated disposal points.*

WARNING



Health hazard due to germs and bacteria in the drinking water!

Contaminated drinking water can cause serious infections.

- Prior to the first use, disinfect the fresh water system of the vehicle, and thoroughly flush with drinking water.
- Transfer water only from supply systems with proven drinking water quality.
- Filling hose and container must be approved for drinking water.

-
- Fresh water becomes undrinkable very quickly! Prior to every start-up, thoroughly flush the fresh water tank, the lines and water cocks with plenty of tap water.
 - Regularly sterilise the fresh water tank. Special sterilizing agents are available from specialised dealers. Comply with the manufacturer's instructions specified on the packaging of the sterilising agent, and with local application guidelines and fresh water regulations.
 - Wear hygiene gloves (from specialist suppliers) when handling the waste water tank and the solid waste container; and thoroughly cleanse any exposed skin.
 - Drain waste water and solid waste tanks only at designated disposal points, never in nature. If needed, information about the nearest disposal station can be obtained from the municipal administration.

2.7 Environmental protection

Cleanliness

Real camping enthusiasts always leave their stopover clean and tidy. Always behave in such a manner that you will be welcomed back!

Many towns and communities offer designated and well-equipped compounds with all necessary supply and disposal facilities for caravans.

Waste

Separate glass, plastic, paper, and kitchen waste, and dispose of waste in the containers provided for the various recyclable materials. If necessary, contact municipal authorities for information on disposal possibilities.

Please note: Do not dispose of household waste in the waste containers provided at rest stops and parking facilities!

Waste water

Do not dispose of waste water in street drains or in free nature!

Always empty waste water and solid waste containers in designated disposal points in camping grounds or specifically equipped communal compounds.

Toilet chemistry

Use only environment-friendly and biodegradable WC chemicals.

Exhaust gases

Do not run the vehicle's engine while parked! While idling, the engine releases a considerable amount of hazardous exhaust gases.

Technical data

3 Technical data

3.1 Nameplate

The nameplate of the motor home is located at the passenger entry. Do not attempt to change or remove the nameplate, it must always remain legible.

LMC Caravan GmbH & Co.KG Rudolf-Diesel-Straße 4 D-48336 Sassenberg	LMC Caravan GmbH & Co.KG e13*2007/46*1226 Stufe 2
22572010 T662	ZFA2500002T58705 3500 kg 5500 kg
	1- 1850 kg 2- 2000 kg

Fig. 1: LMC name plate with EU overall operating licence

LMC name plate with EU overall operating licence

Left side:

- Manufacturer
- Fabrication number
- Type designation
- QR code

Right side

- Manufacturer
- EU type approval number
- Configuration level
- LMC Chassis No.
- Technically permissible mass
- Technically permissible tractor-trailer mass
- Technically permissible mass on axle 1 (front axle)
- Technically permissible mass on axle 2 (rear axle)

3.2 Weight specifications, load distribution and load securing

3.2.1 Technically permissible mass

The technically permissible mass is a value specified by the manufacturer that, for safety reasons, the vehicle must never exceed, even when loaded (e.g. 3,500 kg). Information on the technically permissible mass of the model you have chosen can be found in the registration papers and on the body manufacturer's nameplate in the vehicle.

WARNING



Danger due to overloading!

Overloading the vehicle and the axles may result, for example, in a diminished steering response (altered driving behaviour), an overloading of the tyres, and, as a result, an increased risk of tyre blowouts or an extended braking distance. This may cause you to lose control of the vehicle, endangering yourself and other road users.

- If you are not sure whether the loaded vehicle complies with the technically permissible mass, you can weigh/check the vehicle on public scales or have it weighed by certain dealers.

NOTE



If you drive the vehicle even though it exceeds the technically permissible mass specified by the manufacturer, you may face legal consequences, such as a fine or loss of insurance.

Technical data

3.2.2 Actual weighed mass of your vehicle and remaining load capacity

To determine the remaining load capacity, it is important that you know the actual weighed mass of your tractor vehicle. Upon completion of your vehicle, therefore, we determine the actual mass of your vehicle for the first time by weighing it at the end of the line. This includes the mass in running order plus the weight of all ordered and factory-fitted optional equipment.

You can use this actual weighed mass to calculate the remaining load capacity for baggage or other accessories.

Example:

Specification	Value
Technically permissible mass	3500 kg
Actual weighed mass of your vehicle	- 3000 kg
Mass of the passengers	- 225 kg (3 x 75 kg)
Remaining load capacity	= 275 kg

NOTE



Please note that the factory calculation of the remaining load capacity for the mass of the driver (included in the actual weighed mass of your vehicle) and the mass of the passengers is based on a generalized mass of 75 kg per seat. Due to deviating body weights, however, the actual remaining load capacity of your vehicle may vary.

NOTE

The actual factory-weighted mass may vary slightly afterwards due to weather conditions and, for example, the associated absorption or release of moisture. Any further subsequent modification of your vehicle, e.g. through the additional installation of optional equipment by the dealer or other attachments and/or conversions, will additionally influence the actual weighed mass communicated and consequently also the remaining load capacity. It is the responsibility of the dealer after picking up the vehicle at the factory until delivery, and subsequently your responsibility from the time of handover by the dealer, to ensure that the technically permissible mass is not exceeded. If you are not sure whether the loaded vehicle complies with the technically permissible mass, you can weigh/check the vehicle on public scales or have it weighed by certain dealers.

NOTE

We will inform your dealer of the actual weighed mass of your vehicle and the remaining load capacity when we issue the invoice. Your dealer is required to pass on the information to you. If you have not received this information, you can contact your dealer and request it. Our scales meet all legal and standard requirements and are regularly maintained, tested and, calibrated. Nevertheless, a slight tolerance is technically unavoidable. Moreover, the weight of the vehicle may vary slightly due to weather conditions and, for example, the associated absorption or release of moisture. The actual weight of the vehicle may therefore deviate from the actual vehicle mass communicated by a few kilograms.

Technical data

3.2.3 Technically permissible mass on the axle (mass on the axle)

The technically permissible mass on the axle (mass on the axle) refers to the vehicle- and axle-specific load that may be transferred from the wheels of an axle or group of axles to the road surface. The technically permissible mass (mass on the axle) is a value specified by the manufacturer that, for safety reasons, the vehicle must never exceed, even when loaded. You will find information on the technically permissible mass on the axles (masses on the axles) of your vehicle in the registration papers and on the body manufacturer's nameplate in the vehicle.

WARNING**Hazards due to exceeding of the technically permissible mass on the axle!**

If the technically permissible mass on the axle (mass on the axle) is exceeded, the vehicle may be damaged (e.g. due to a broken axle or tyre blowout) and driving performance may be considerably impaired. This may cause you to lose control of the vehicle, endangering yourself and other road users.

- We therefore recommend weighing the final loaded vehicle including all passengers before commencing travel in order to ensure compliance with the technically permissible mass on the axles (mass on the axle) and the technically permissible mass at all times. For this purpose, you can weigh/check the vehicle on public scales or have it weighed by certain dealers.

NOTE

Please note that the mass on the respective axles or axle groups may differ. For this reason, please read the information provided in the registration papers carefully.

NOTE

If you drive the vehicle even though it exceeds the technically permissible mass on the axle (mass on the axle) specified by the manufacturer, you may face legal consequences, such as a fine or loss of insurance.

NOTE

It is possible that the chassis manufacturer of your vehicle specifies a minimum load for the front axle in order to achieve optimum driving behaviour. Therefore, please also always observe the information regarding this from the operating instructions of the chassis manufacturer.

NOTE

For further information on correct loading, please refer to the chapters "Load distribution and load securing" and "Rear garage and rear storage space (model-dependent)".

3.2.4 Increase in load capacity and reduction in load capacity

In the case of an increase of load capacity, a change in the chassis usually increases the technically permissible mass of the vehicle, the technically permissible mass on the axle (mass on the axle) and, as a result, the remaining load capacity for luggage, camping equipment, etc. In contrast to an increase of load capacity, a reduction of load capacity reduces the technically permissible mass of the vehicle, the technically permissible mass on the axle (mass on the axle) and, as a result, the remaining load capacity for luggage, camping equipment, etc. As a rule, a technical modification of the chassis is not performed.

Technical data

NOTE

Due to the change in the technically permissible mass, increases or reductions of load capacity may affect the permitted seats, the chassis, and the technically permissible mass on the axles (mass on the axle). If you have any questions, feel free to contact the responsible technical testing centre for advice.

NOTE

A reduction or increase of load capacity may result in changes to the legal requirements resulting from the new technically permissible mass of the vehicle. This applies in particular to the legal requirements from the German Road Traffic Act (StVO), the German Road Vehicle Registration Regulation (StVZO), and tax and insurance regulations. An increase of technically permissible mass to over 3,500 kg may, for example, affect the driving license class or result in different speed limits or prohibitions on passing and overtaking. Toll payment requirements may also change due to the new technically permissible mass. Therefore, inform yourself about the current legal situation with regard to the new technically permissible mass of the vehicle and seek advice on this from the appropriate bodies. Please note that national regulations in the country of your destination and countries visited in transit may differ from those in your home country.

NOTE

For more information on the actual weighed mass of your vehicle and the remaining load capacity, please refer to the chapter "Actual vehicle mass and remaining load capacity".

3.2.5 Load distribution and load securing

When loading the vehicle, please observe the following instructions to ensure safe driving:

- Baggage and other items carried in the vehicle must be evenly distributed between the left and right sides of the vehicle.
- Heavy or bulky items should be stowed as close to the ground as possible in stowage boxes provided for this purpose and near the axles, and they must be secured against slipping.
- Light and other items can be stowed in lockers and storage compartments.
- Always ensure that the doors and flaps on the cabinets and storage compartments are properly secured.
- Use only suitable clamping systems to secure items against slipping. Please recheck all tie-downs before commencing travel.

WARNING



Dangers due to uneven loading!

Uneven loading has a negative effect on driving behaviour. A rear-heavy load in particular results in a reduction of the load on the front axle due to leverage effects and thus, for example, to a loss of traction, a diminished steering response (altered driving behaviour), an overloading of the tyres and, as a result, an increased risk of tyre blowouts. This may cause you to lose control of the vehicle, endangering yourself and other road users.

- An evenly distributed load over the entire vehicle leads to optimum driving behaviour during travel.

Technical data

NOTE

The technically permissible mass and the technically permissible mass on the axle (mass on the axle) must not be exceeded. Especially when stowing or attaching heavy optional equipment or heavily laden optional equipment (such as motorcycle carriers or bicycle carriers) at the rear, the mass on the axle (masses on the axles) must be checked and complied with. If you are not sure whether the loaded vehicle complies with the technically permissible mass and the technically permissible mass on the axle (mass on the axle), you can weigh/check the vehicle on public scales or have it weighed by certain dealers.

NOTE

For individual models, a maximum load is specified by the body manufacturer for cabinets, drawers, storage compartments, or other storage spaces. This maximum load can be seen on the stickers attached on site and must be observed at all times. However, the technically permissible mass and the technically permissible mass on the axle (mass on the axle) must not be exceeded under any circumstances. For this reason, please note that the stated maximum load may not be fully utilized if this would result in the exceedance of the technically permissible mass or technically permissible mass on the axle (mass on the axle).

NOTE

Further information on correct loading can be found in the following chapters

- “Technically permissible mass”
 - “Technically permissible mass on the axle (mass on the axle)”
 - “Rear garage and rear storage space (model-dependent)”
-

3.2.6 Rear garage and rear storage space (model-dependent)

When loading rear garages and rear storage compartments, please observe the following instructions to ensure safe driving:

- Baggage and items carried in rear garages and rear storage compartments must also be evenly distributed in accordance with the chapter "Load distribution and load securing".
- All items stowed in rear garages and rear storage compartments must be fastened and secured accordingly using suitable clamping systems at the existing fastening points provided at the factory.
- Before driving off, it must be ensured that the rear garage or rear storage compartment is properly locked.

WARNING



Dangers due to uneven loading! or overloading!

Uneven loading or overloading has a negative effect on driving behaviour. A rear-heavy load in particular results in a reduction of the load on the front axle due to leverage effects and thus, for example, to a loss of traction, a diminished steering response (altered driving behaviour), an overloading of the tyres and, as a result, an increased risk of tyre blowouts. This may cause you to lose control of the vehicle, endangering yourself and other road users.

- An evenly distributed load over the entire vehicle leads to optimum driving behaviour during travel. If you are not sure whether the loaded vehicle complies with the technically permissible mass and the technically permissible mass on the axle you can weigh/check the vehicle on public scales or have it weighed by certain dealers.

WARNING**Danger due to flammable material!**

When transporting vehicles powered by gasoline, diesel, gas, or other flammable material, make sure that the tank of the transported vehicle is completely empty.

- When transporting electric bikes, we also recommend that you remove and securely stow the battery before commencing travel.

WARNING**Risk of suffocation!**

Rear garages and rear storage compartments are not designed at the factory to function as sleeping or living areas for people or animals. These spaces are not provided with ventilation at the factory. There is a risk of suffocation due to a lack of oxygen.

NOTE

Please observe the maximum permissible load of the rear garage or rear storage compartment at all times. The specified maximum permissible load of the rear garage or rear storage compartment may be influenced by the selection of further optional equipment, such as trailer couplings or frame extensions. However, the technically permissible mass and the technically permissible mass on the axle (mass on the axle) must not be exceeded under any circumstances. Especially when stowing or attaching heavy optional equipment or heavily laden optional equipment (such as motorcycle carriers or bicycle carriers) at the rear, the technically permissible masses on the axles (masses on the axles) must be checked and complied with. For this reason, please note that the maximum load may not be fully utilized if this would result in the exceedance of the technically permissible mass or technically permissible mass on the axle (mass on the axle).

NOTE



Further information on correct loading can be found in the following chapters

- “Technically permissible mass”
- “Technically permissible mass on the axle (mass on the axle)”
- “Load distribution and load securing”

3.3 Built-in devices

The technical data of the built-in devices are provided in the respective operating manuals. These are in the document case. Depending on the selected fittings, they include the documentation for:

- Kitchen appliances (e.g. refrigerator, oven, grill)
- Heater, boiler, sanitary system
- Electric control, storage battery, charger
- Optional equipment (e.g. grill)

3.4 Fuses and fuse plug-ins

230 V and 12 V are available in the motorhome. Both circuits have their own fuse system.

3.4.1 230 V input and main fuse

Power connection



Fig. 2: Electrical connections

The connection to the 230 V power supply can be found outside the vehicle along the side wall.

The 3-pole CEE plug installed permanently in the motor home is used as connection.

NOTICE



Before travelling to foreign countries, obtain information about the plug and connector systems used at your destination. Suitable adapters are commercially available.

Technical data

Main switch for the electrical system of the motor home



A ground fault circuit interrupter (main switch) protects the electrical system of the motor home.

The main switch box is located inside the wardrobe or in the adjacent storage room.

- Turn the main switch to position "0" if the motor home is not in use (e.g. during the winter months). This disconnects all devices from the 230 V power supply.

Fig. 3: Ground fault circuit interrupter (GFCI)

230V outlet



Outlets for the connection of small appliances when an external power supply is connected can be found at various locations in the vehicle interior, depending on the model and selected equipment (the picture shows an outlet in the support of the sitting area).

Fig. 4: 230 V outlet, example

3.4.2 12 V fuses in the motorhome

The Elektroblok EBL 400 A is installed in front left side seat bench. This is the central power supply system for all 12 V consumers in the electrical system.

On the rear side of the device there are four possible plug connections next to the 230 V connection, see the table for Fig. 5.

EBL 400 A Rear Side

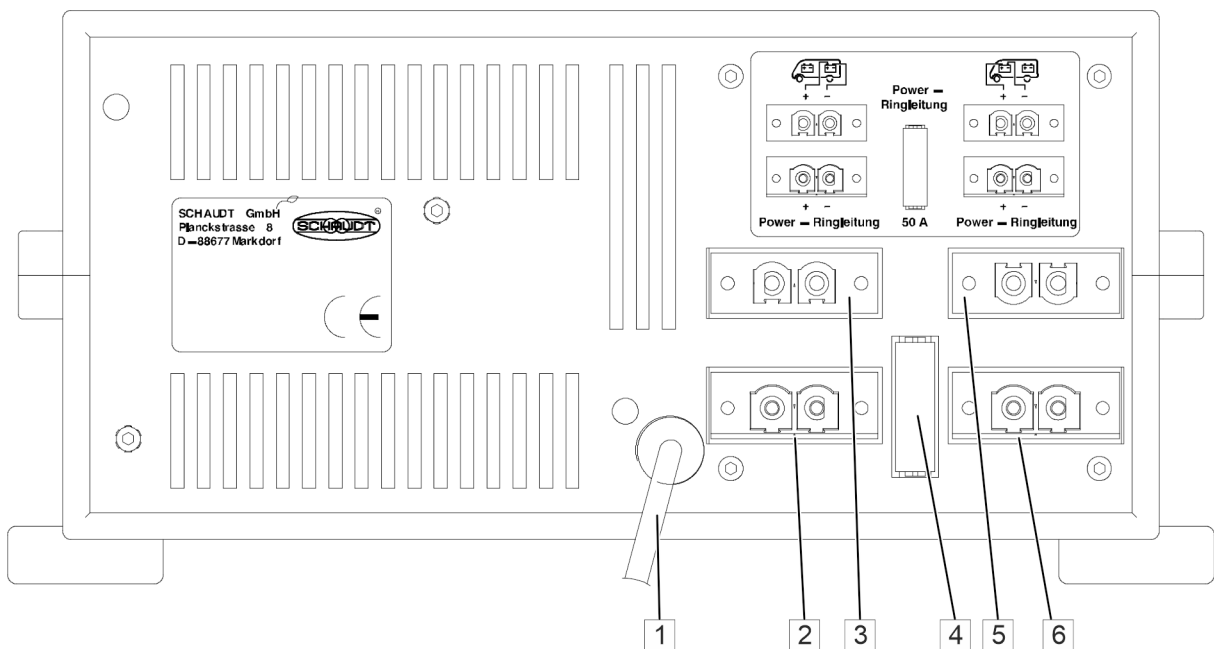

Fig. 5: Layout of the fuse plug-ins on the EBL 400 A (rear side)

Item	Code	Meaning	Use
1	Cable	Power connection	Power supply 230 V AC (WAGO plug)
2	Power	Connector	Not used
3	WB	Connector	Living space battery connection
4	Fuse	50 A	No function because item 2 and item 6 are not used
5	SB	Connector	Starter battery connection
6	Power	Connector	Not used

Technical data

EBL 400 A Front

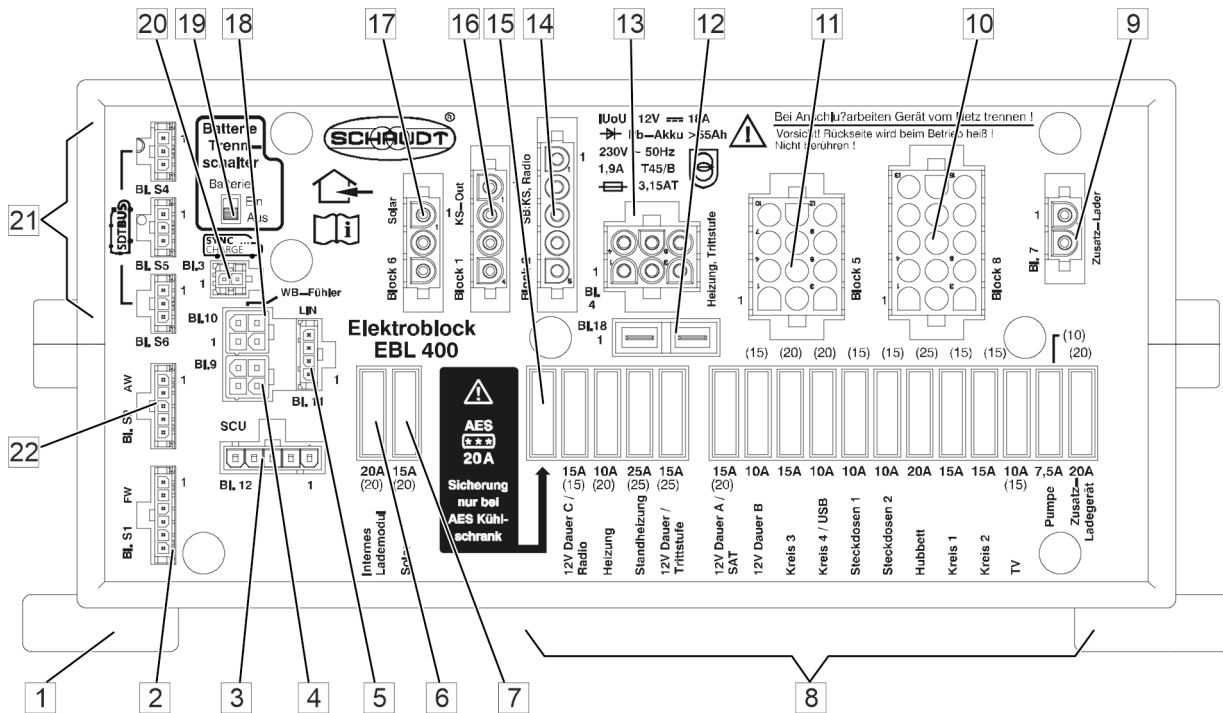

Fig. 6: Layout of the fuse plug-ins on the EBL 400 A (front)

Item	Code	Meaning	Use
1	Mounting feet (4 x)		
2	Bl. S1	Block S1	Fresh water probe
3	Bl. 12	Block 12	SCU (not used)
4	Bl. 9	Block 9	TFS01 (parallel to bl. 10)
5	Bl. 11	Block 11	LIN bus
6	Internal charge module	Fuse	
7	Solar	Fuse	
8	Vehicle FKS fuses	Fuses	Fusing of the 12 V consumers
9	Block 7	Block 7	Spare charging unit
10	Block 8	Block 8	Supply, 12 V consumers
11	Block 5	Block 5	Supply, 12 V consumers
12	Bl. 18	Block 18	Tank heating waste water tank

Item	Code	Meaning	Use
13	Block 4	Block 4	Heating, step
14	Block 2	Block 2	D+ input, KS starter battery
15	AES 20 A	Fuse	20 A fuse for compressor refrigerator
16	Block 1	Block 1	Refrigerator
17	Block 6	Block 6	Solar charge controller
18	Bl. 10	Block 10	TSF01 (parallel to bl. 9)
19	Battery On/Off	Battery isolator	
20	Bl. 3	Block 3	SYNCCHAR®
21	Bl. S4, Bl. S5, Bl. S6	Block S4, S5 and S6	SDTBUS®
22	Bl. S2	Block S2	Waste water probe/sensors

Technical data

Power circuits inside the motorhome The power supply of the motorhome is divided into the following separate circuits.

Power circuit	Allocation (elements depending on model)
Normal light	Drain valve for non-freezing liquid Power-operated entrance step Ceiling light Awning light
Lighting circuit 1	Interior lighting and power outlets
Lighting circuit 2	Interior lighting and power outlets
Consumer	Refrigerator Heater Pump

When the supply battery is connected and switched on, the normal light circuit is always activated. Only when activating the disconnect switch on the charger unit, this light circuit will be switched off.

The light circuits 1 and 2 are switched by activating the light circuit ON/OFF switch on the operating unit. When leaving the vehicle, is mandatory to switch off these light circuits.

In the 12 V refrigerator can only be operated while the vehicle engine is running. When switching the engine off, a cut-off relay prevents deep discharge of the supply battery.

3.4.3 Additional plug-in fuse slots

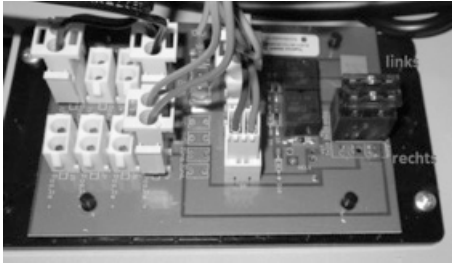

Fig. 7: Interface module



Fig. 8: Interface module under the driver's seat

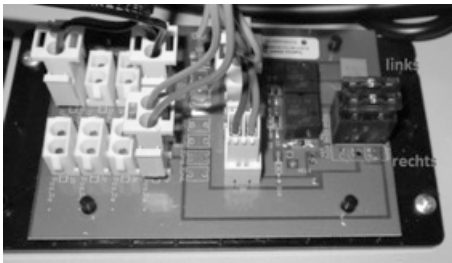

Fig. 9: Interface module

There are multiple fuse distribution boxes in the vehicle for the plug-in fuses:

1. Consumers on the fuse distribution box, dashboard
2. Fuse distribution box in engine compartment
3. Consumers on the optional control module in the right centre pillar
4. Side marker light/side indicator light interface module behind the 'Elektroblock' under the driver's seat.

There is a comprehensive list of the plug-in fuses in the appendix.

Access to the interface module's fuse location can be gained by moving the driver's seat forward.

When changing the fuses, compliance with the operating instructions of the base vehicle manufacturer is mandatory!

There are multiple fuse distribution boxes in the vehicle for the plug-in fuses:

1. Interface module under the front right seat:
 - 5 A = Side marker light / position lights
2. Next to the living space battery:
 - 50 A = Main fuse
 - 2 A = Fuse, measurement device for the living space battery for the booster
 - 2 A = Fuse, measurement device for the living space battery for EBL 400

Driving

4 Driving

Basic information

When driving your motor home, always comply with the regional traffic regulations and laws. Carefully plan your route in advance. Drive carefully and in an environmentally responsible manner.

Bear in mind that your motor home a utility vehicle and its dimensions and weight that are significantly greater than those of a passenger car. Bear in mind that all vehicles exceeding a total weight of > 3.5 t are subject to the regulations applicable to lorries.

How to operate the motor home properly is described in detail in the applicable operating manual of the base vehicle. Always keep this operating manual on board for easy access for anyone driving the vehicle. Comply with the information and the handling instructions provided in the manual.

In addition, always comply with the instructions specified in the "Safety" section of this manual.

- Drive slowly if the road conditions are poor.
- When driving onto ferries, travelling along rough terrain (potholes or bumps), and while reversing the vehicle, special care is highly recommended. When large vehicles encounter the above-mentioned road conditions, the relatively long overhang can cause them veer off and "bottom out". This may damage the underbody or parts that are not mounted to the underbody.
- If an accident or damage occurs to the vehicle due to non-compliance with this advice, the manufacturer cannot be held liable.



Fig. 10: Seats with restricted use

WARNING



There is an elevated risk of injuries if seats designed without safety belts are used while travelling!

Depending on the vehicle type and model, passengers must only be seated on seats intended to be used by the passengers while the vehicle is moving. The symbol on the left-hand side indicates that this seat must not be used while the vehicle is moving.

- While travelling, passengers are not permitted to occupy a seat that is identified with the symbol (Fig. 10) shown on the left-hand side.
- Always ensure, all passengers wear their seatbelts.
- Children under the age of 6 shall not be seated in the passenger seat – even if a child seat is used!

Roof loads

WARNING**Risk of accident and injury due to unsecured roof loads!**

Roof loads that are not properly arranged and secured can cause accident.

- Only load the roof if the roof carrier is properly installed.
- Do not load or step onto the front area of the roof. This area is not designed to bear loads.
- Do not exceed the maximum permissible roof capacity of 75 kg. Considers snow and ice loads.
- Only light loads such a surfboard, rubber dinghy, light canoe or similar sports equipment may be loaded onto the roof.
- The insured to distribute the equipment evenly and lash it securely. Do not use bungee cords.
- Always consider the total height of the motor home including equipment loaded onto the roof.

CAUTION**Slip hazard due to smooth roof surfaces!**

Walking on wet or icy roof surfaces may cause a person to fall and sustain severe injuries.

- Before climbing onto the vehicle's roof, remove all wet spots and debris thoroughly.
- Only use the ladder attached to the vehicle to climb onto the roof.
- When climbing onto the roof, non-slip footwear must be worn.
- Do not step onto the front area of the roof.

Driving

4.1.1 Reviewing the check list

Before leaving for your journey, check all travel documentation and equipment:

Checks	✓
All vehicle documents are on board (operating manuals for motor home, base vehicle, installed equipment and devices)	
Motor vehicle Registration certificate, Part I carried by the driver	
Certificate of insurance in the vehicle	
Travelling documents for all passengers in the vehicle	
Currencies of transit countries and destinations in the vehicle	
Trip route, road maps, country information in the vehicle	
All luggage is properly stored	
If pets are travelling along, veterinary certificates required for transit countries and destinations are in the vehicle	
Road regulations for motor homes in the transit countries and destinations are known	

4.2 Checking the vehicle

WARNING



Danger of accident and injury due to vehicle defects!

Defects on and in the vehicle can cause accidents with severe to fatal injuries as the consequence.

- Prior to every start, check the vehicle and the load for condition and driving safety.

Copy and supplement the list on the following page and, before starting the journey, check-mark each line after completing the relevant task.

Tasks and checks that must be executed immediately before starting the journey	✓
1. Free vehicle, particularly the roof, from deposits such as branches, twigs, leaves, snow, and ice.	
2. Check the functioning of signalling and lighting equipment.	
3. Ensure faultless functioning of brakes and steering gear.	
4. Check rims and tyre tread for proper condition. Ensure that the tyres are inflated to the proper pressure.	
5. Check all operating fluid levels (engine oil, power steering oil, brake fluids, cooling fluids and windscreen washer fluid), top up if required.	
6. Lock all swivel/rotary seats in the direction of travel.	
7. Check load for proper distribution and fastening.	
8. Close and secure all inner and outer doors, service hatches, windows and skylights.	
9. Close and secure the pop-up top, if fitted.	
10. If fitted, move the lift-up bed into the top position (travel position).	
11. Before driving, fold down the alcove bed.	
12. Close and secure cabinets, refrigerator doors and cover plates for hob and sink.	
13. Lock all tables and beds into place. Use the safety belts to secure the lift-up bed.	
14. Completely open and secure the blinds on the windscreen and on the driver and passenger windows.	
15. Push in the TV tray. Close the hatch or secure the TV tray against twisting.	
16. Switch the refrigerator to internal 12 V power supply.	
17. Disconnect the external 230 V power supply with CEE plug.	
18. Close gas bottle valves and quick-action valves.	
19. Seat the children according to their age and size in the specified child seats and buckle the children up.	
20. All passengers must be placed in the appropriate seats and seat belts must be tightened.	
21. Remove the wheel chocks and retract the vehicle supports.	
22. Carefully retract the entrance step.	

4.3 Fuelling

- Comply with the safety and operating instructions in the operating manual provided by the manufacturer.

WARNING



Poisoning, fire, and explosion hazard due to fuel!

Fuel can cause severe health hazards, it is highly inflammable and may lead to injuries or may cause damage to the environment and result in physical damage.

- Prior to fuelling, ensure the petrol system is switched off. Close all petrol appliances, quick release fastness and gas cylinders.
- Never confuse the fuel filler cap with the fresh water inlet! Only a few drops of fuel will contaminate the entire fresh water system.
- Any fuel spillage must be wiped up immediately and disposed of.

CAUTION



Damage to the petrol tank due to inadvertently adding water!

- Water in the petrol tank can damage the engine or may lead to the total failure of the engine.
 - Never add water or any other inappropriate fluids to the petrol tank.
 - Always lock the petrol tank.



Fig. 11: Fuel filler cap, example

1. Open the lid of the fuel filler cap.
2. Remove the screw-cap.
3. Insert the petrol pump nozzle of the appropriate fuel type into the filler neck and start fuelling the vehicle.
4. Remove the petrol pump nozzle from the filler neck and return the nozzle to the petrol pump.
5. Lock the screw cap.
6. Close the lid.

NOTE



On vehicles fitted with a diesel heater, do not drain the vehicle tank as far as the "reserve" position of the fuel tank gauge.

4.4 Starting your journey

4.4.1 Entering

Open the entry door from the outside



Fig. 12: Door handle, key with remote control for the central locking system

The body door can be unlocked both with the ignition key, with the radio remote control and also with the body keys.

1. Press the button (1) on the key with the remote control for the central locking system or use the key to open the lock.
2. To open the door, pull on the door handle.

Alternatively:

1. Insert the key for the motorhome and turn 90 degrees to the right
2. To open the door, pull on the door handle.

Adjust seats and headrests

1. If the driver and front passenger seats are swivelling, they must be aligned with the direction of travel and fixed into position.
2. Adjust the backrests of the seat in the upright position.
3. Adjust the head rests to ensure your head is properly supported at the height of your ears.

How to buckle on the safety belts

WARNING



Risk of injury due to improperly adjusted or damaged safety belts!

Improperly adjusted or damaged safety belts do not provide the necessary protection! Accidents can cause severe or fatal injuries.

- Always check the safety belts for their flawless condition. Damage safety belts must be replaced.
- Over-extended belts or belts that were subjected to excessive loads (e.g. after an accident) must be replaced.
- When putting on the safety belts, ensure they are not twisted.
- Seat the children according to their age and size in the specified child seats and buckle the children up.
- It is highly recommended not to seat children under the age of 6 in the passenger seat – even if a child seat is used!



Fig. 13: Three-point safety belt

Three-point safety belt

1. Take a seat on one of the passenger seats.
2. Pull the upper belt webbing diagonally across the shoulder and chest and guide the lower belt webbing across your hip (→ Fig. 13).
3. Insert the latch into the belt buckle until a clicking noise is audible, then tighten the belt strap. Ensure the safety belt is secured and tight.
4. To remove the belt, press the coloured button on the belt locking mechanism.

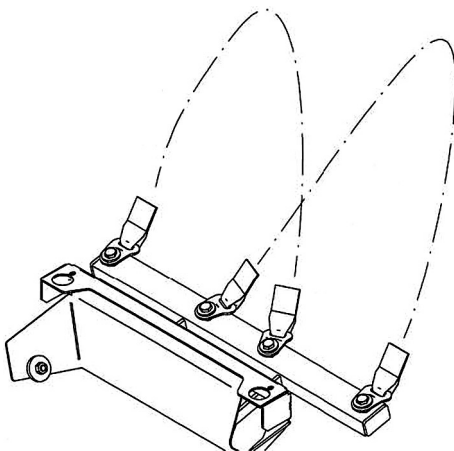

Fig. 14: Pelvic restraint belt

Pelvic restraint belt

NOTICE



The pelvic restraint belts on the seats that are facing in the opposite direction of travel must be attached so that both belts cross each other in the centre (→ Fig. 14).

1. Placed the belt across the pelvic.
2. Insert the latch into the belt buckle until a clicking noise is audible, then tighten the belt strap. Ensure the pelvic restraint belt is secured and tight.
3. To remove the pelvic restraint belt, press the coloured button on the belt locking mechanism.

4.5 Travelling and parking

Travelling

WARNING



Improper and erratic driving increases the list of injury and accident!

Improper and erratic driving can result in an accident with serious or fatal injury as consequence.

- Different handling characteristics, longer braking distances, increased overall weight and dimensions of the vehicle that exceeded the distinctive features of a passenger car must be taken into consideration.
- Compliance with the local traffic regulations is mandatory.
- Always adjust your driving style to the current road, traffic, and weather conditions.
- The driving restrictions applicable a motor home must be obeyed.
- Headways (height and width clearances) in front of car parks, ahead of subways, bridges and tunnels, and on the vehicle loading decks of ferries must be observed.
- Avoid sudden and abrupt braking.
- Drive slowly if the road condition is poor.
- Avoid to bottom out the vehicle when driving on ramps, rough terrain or when reversing the motor home.
- The number of persons travelling in the car must not exceed the permitted maximum number of passengers (→ see vehicle registration document).
- While driving the vehicle, all passengers must wear their seatbelts.
- Never opened the door locking mechanism while driving.

Driving

Parking

WARNING



Risk of injury due to an unsecured vehicle!

Unsecured vehicles can roll away and cause serious injury or material damage.

- Never stop or park the caravan on steep slopes, embankments or gradients.
- When stopping or parking the vehicle, always secure with wheel chocks against uncontrolled rolling away.

-
1. Turn off the engine.
 2. 1. Shifting the gear. If driving a vehicle with an automatic transmission, place the selection lever in park position "P".
 3. Firmly engage the parking brake.
 4. On slight inclines, slopes, or embankments, place wheel chocks in front of and behind one or more wheels of the caravan. (This is mandatory for all vehicles with a permissible total weight of 4 t).

NOTICE



Do not use wheel chocks to compensate for uneven terrain.

4.6 Parking the motor home at the destination

4.6.1 Parking the motor home

Selecting a parking place

For optimal and trouble-free use of all technical vehicle equipment, select the parking place in accordance with the following criteria:

- Stable, horizontal, level surface.
- Electrical mains connection in the immediate vicinity (maximum distance: 25 metres).
- Fresh water and waste water connections as well as approved disposal station in the immediate vicinity.
- Adequate parking space dimensions ensuring that all doors and maintenance hatches are accessible after parking the caravan.

Parking a motor home

1. Turn off the engine.
2. 1. Shifting the gear. If driving a vehicle with an automatic transmission, place the selection lever in the park position "P".
3. Firmly engage the parking brake, use wheel chokes if necessary.

NOTICE



Do not use wheel chocks to compensate for uneven terrain.

4. Extend rear jacks, if installed.

4.6.2 Extending the rear support

WARNING



Crushing hazard when extending or retracting the support elements!

Extending and retracting support elements can cause feet, hands, or other body parts to be crushed and injured.

- Do not position yourself in the swivel area of the supports.
- Do not tamper with support elements.

NOTE



On soft, yielding surfaces, place large plates under the supporting elements before extending to prevent them from sinking into the ground.

NOTE



The supporting elements do not serve as vehicle jacks, rather they are used exclusively to stabilise the vehicle.

When extending, load all supporting elements uniformly.

To compensate for inclines use special drive-on wedges that are commercially available!

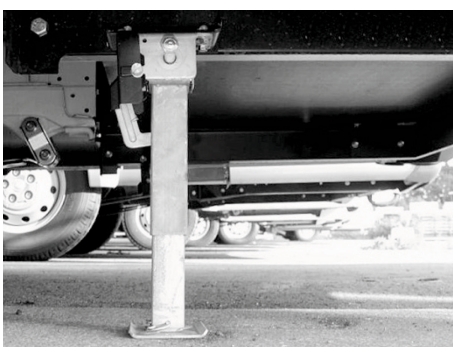

Fig. 15: Rear jack extended

1. Insert the socket wrench into the hexagon opening of the rear jack.
2. Rotate the socket wrench clockwise until the jack is in its horizontal position.
3. Continue to turn the socket wrench clockwise until the extension of the jack rests firmly on the ground and the vehicle is in a secured position.

4.6.3 Retracting the rear support

WARNING

**Risk of injury due to improperly retracted jack!**

Jacks that are not properly retracted can cause accidents, severe injury and material damage.

- Prior to starting the journey, ensure all jacks are properly retracted.
- Check the extension of the jack and ensure it is properly retracted and secured.

-
1. Insert the socket wrench into the hexagon opening.
 2. Turn the socket wrench anticlockwise until it contacts the mechanical stop, the jack extensions are retracted and the rear jack is folded up.

Overview

5 Overview

General

This section provides an overview of the caravan body and its equipment. The arrangement and important control elements of the built-in devices are explained.

Several equipment elements are presented as examples, or are presented in different model variants in the descriptions below. The variant actually installed the vehicle in these cases always depends on the model or price, and due to its design cannot always be replaced with a different variant. Claims to equip the vehicle with a specific variant cannot be derived from this operating manual.

NOTE



Some of the built-in items described here are only available as optional equipment. These equipment elements are only in your caravan body if they were specifically requested when the vehicle was ordered.

■ Optional equipment

Optional equipment (identified below by "(optional)") directly affect the design, manufacturing and price of a vehicle and, in most cases, it cannot be retrofitted or installed at a later time. Optional equipment requirements that are not directly listed in the purchase contract cannot be derived from this operating manual.

A binding list of the standard equipment in your vehicle is shown in the price list used when your vehicle was ordered.

5.1 Caravan body

5.1.1 Keys for the motorhome

When you pick up the motorhome, two key are also provided for the body of the motorhome; these are suitable for the following locks:

- Entry door lock
- Lock on the filler neck for potable water
- Lock on service and storage flaps

5.1.2 Entrance door



Fig. 16: Entry door to the motorhome

The entry to the living area is on the right side.

The door can be locked from the outside with a safety lock that can also be locked and unlocked from the inside.

Depending on the model and the selected equipment, an awning light (optional) above the door illuminates the entry at night.

A step in the entrance makes access to the living area easier.

A waste container can be found on the inside of the entry door. Sliding blinds are installed on the inside of the door's window.

Optionally, the entrance can be provided with a fly-screen door, which is attached on the inside of the side wall. When the fly screen is drawn across, it allows the vehicle to be ventilated while the entry door is open while keeping insects away from the interior.

CAUTION



Damage due to incorrect use!

When entering and exiting the vehicle and when closing the entrance door, the fly screen may be damaged by the waste container.

- Always return the extended fly screen back into the holder first!

Overview

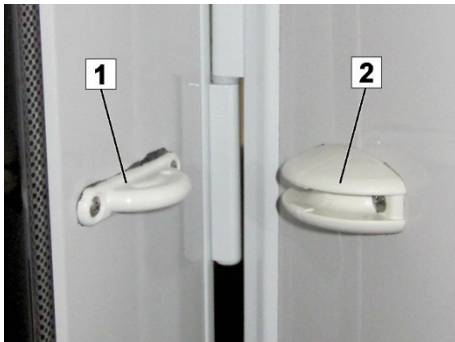

Entrance door and large hatches can be locked in open condition. This prevents unintentional slamming of doors and hatches i.e. by the wind.

- To hold the door or hatch in place, carefully open the door until the stop and then press it lightly against the holder until the catch lock (1) engages in the receptacle (2).
- To release, pull the door or hatch out of the holder with a light jerk.

Fig. 17: Door and hatch locks

Open the entry door from the outside



The body door can be unlocked both with the ignition key, with the radio remote control and also with the body keys.

1. Press the button on the key with the remote control for the central locking system or use the key to open the lock.
2. To open the door, pull on the door handle.

Alternatively:

1. Insert the key for the motorhome and turn 90 degrees to the right
2. To open the door, pull on the door handle.

Fig. 18: Door lever

Interior door lock, body door



Fig. 19 Interior door with grab bar and handle, example

The door latch can be locked from the inside.

- To lock, push the handle in as far as it will go in the door case.
- To open, swing the grab bar away in a downwards direction.
- Prior to starting the journey, always close and lock the door!

Alternatively, the body door can also be opened and closed via the chassis central locking system so that the lock closes or opens.

Overview

5.1.3 Door and hatch locks

CAUTION



Open hatches can cause damage!

Open hatches can hit street signs, light poles, and other obstacles while driving and cause severe damage to the vehicle and third-party properties.

- Never drive with opened hinged windows/hatches!



Depending on the model and selected equipment, hatches are located on the outside of the caravan. e.g.: accesses to rear external storage locker, hot water tank, to small storage compartments (for vehicle accessories, tools, car jack) and for the toilet waste holding tank.

NOTICE



Always keep hatches closed. This will prevent loss of equipment and theft!

Fig. 20: Service compartment on the outside of the caravan; example: Small storage compartment for frequently used vehicle tools and travel equipment

Service compartment lock



Fig. 21: Service compartment lock

The service locks can be operated with the body door key. They are not operated via remote control.

Opening the service compartment:

- Use the key to unlock the lock and clockwise rotate the knob by 90°. At this position, the contact pressure abates but the service compartment cannot yet be opened.
- To open the service compartment, rotate the knob clockwise by another 90°.

Closing the service compartment:

You can re-engage the lock in opened conditions. Then, after closing the hatch, it is only necessary to turn it back through 180 degrees and press it in so that it again locks.

ATTENTION



Property damage due to inserted keys!

Keys that are not removed can cause severe scratches in the outer shell of the caravan body. Keys can break off.

- Always remove the key immediately after opening or closing locks.

Lock on the fresh water intake port



Fig. 22: Fresh water intake port

The lock for the fresh water fill intake port is located directly in the closure cap.

- To open, or close, hold the closure cap firmly and turn the lock 180°.

Overview

5.1.3.1 "THULE Excellent" (optional) bicycle carrier

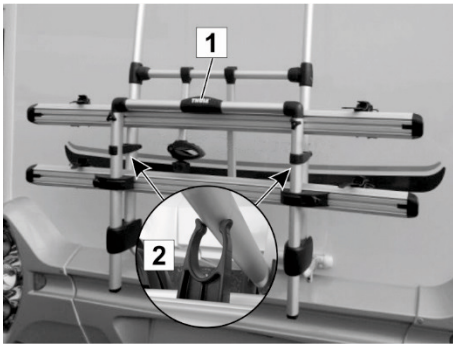

Fig. 23: Fold out the bicycle carrier

Fold out the bicycle carrier

1. Pull handle (1) until both brackets (2) can be released from the frame.

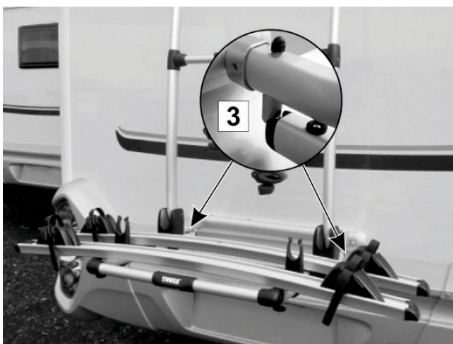

Fig. 24: Snap in the latching mechanism

2. Fold down the bicycle carrier and engage into both latching mechanisms (3) on the left- and right-hand side.



Fig. 25: Secure bicycles

How to load and secure the bicycles

1. Loosen the fastening belt of the support rail (4) and the upper mounting strut (5).
2. Place bicycles onto the support rail and use the fastening belt and the mounting strut to secure the bike.



Fig. 26: Rotating the handle

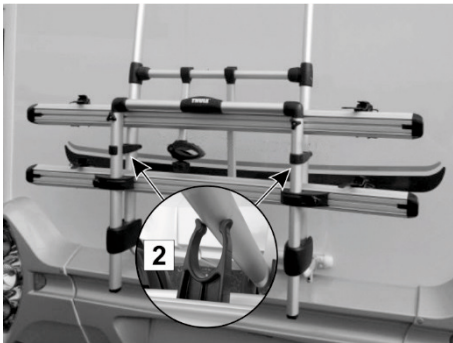

Fig. 27: Folding up the bicycle carrier

How to collapse the bicycle carrier

1. In order to loosen the left- and right-hand latching mechanism, turn handle (1) down and slightly fold up the bicycle carrier.
2. Release the handle.
3. Fold up the bicycle carrier and engage both bracket (2) onto the frame.

NOTICE



For detailed information, refer to the operating instructions of the bicycle carrier manufacturer!

5.1.4 Hinged window



Fig. 28: Hinged window

CAUTION



Open windows can cause material damage!

Projecting windows can hit signs, light poles, and other elements during driving, and cause severe damage to the vehicle and other property.

- Never drive with opened hinged windows. Locking in the ventilation position is not permitted when driving.
- Before starting the journey turn **all** of the sash fasteners to the closed position.

Overview

Correct locking of the hinged windows before any journey

Depending on the floor plan, the vehicles are equipped with different types of hinged windows.

The sash fasteners of the hinged windows have three positions:

In the open position, the sash fastener is not against the clamping block.



Fig. 29: Open position

In the ventilation position, the sash fastener is positioned centrally in the clamping block.



Fig. 30: Ventilation position

In the closed position (sash fastener position for driving) the sash fastener is located on the inside of the clamping block.

Before driving, it must be ensured **that all** sash fasteners are in the closed position (Fig. 31).

Only with locking of **all** sash fasteners is it ensured that the hinged windows remain securely closed and that property damage and personal injury are prevented during driving.



Fig. 31: Closed position

5.1.5 Combination blinds

Combination blind



Fig. 32: Combination blind

The hinged windows are fitted combination blinds consisting of a fly screen and a blackout blind. Both blind components are hung from the window top.

For both blinds:

- To close, use the handle to pull the fly screen fully downward and slightly push against the window until the lower strip latches.
- To open, push the handle downward and slightly pull toward yourself until the lower strip detaches. Due to the tension, the blind automatically rolls up – hold the handle during this action.

The blackout blind can be lowered in three different heights. It latches in one of three possible positions in the lateral guide rails.

ATTENTION



Damage to the blinds if they fly up!

To avoid damage to the blind, ensure that the blind CANNOT fly up.

NOTE



Do not keep the blind closed during driving and over a longer period of time (several weeks).

Over time, the springs would suffer if the blinds are permanently lowered.

Re-tensioning the blinds

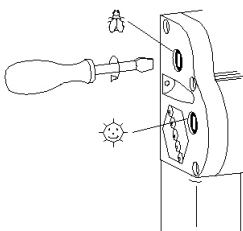

Blind care

Use a screwdriver to re-tension the blind springs.

- Insert the screwdriver and turn once or twice clockwise.
- Check the tension and repeat the process, if required. Ensure that you don't over-tension the springs.

As a rule, never use aggressive cleaning agents (solvents or abrasives). Use a damp cloth and soapy water to clean the blinds and frame parts. Use a soft brush and/or damp cloth to clean the fly screen.

Overview

5.1.6 Driver cab curtain



Fig. 33: Example of a curtain installed in the driver's cab

While the vehicle is parked, an all-around curtain inside the vehicle's cabin can be drawn to prevent someone on the outside to look into the interior of the motor home.

If needed, simply use the press studs to install the driver's cabin curtain.

However, while driving, the view to the front and the side windows must not be obstructed, covered or shaded in any other way.

- Therefore, it is highly recommended to remove the driver's cabin curtain from the windows completely!

5.1.7 Air conditioning system (optional)



Fig. 34: Air conditioning system (optional)

As a special option, a special attachment air conditioner is available to regulate the room temperature of the interior.

In summer operation the air conditioner generates dehumidified cool air. In winter operation it generates supplemental warm air, without, however, replacing the heater of the vehicle.

The air conditioner is installed in the vehicle roof.

Operation, maintenance, and service of the air conditioner are described in detail in the corresponding operating manual.

NOTE



Retrofitting of an air conditioning system is not possible due to the lack of roof reinforcement!

5.1.8 Skylights

Different models of skylights are installed in the ceiling depending on the model and selected equipment. The skylights are opened and locked from inside.

The skylights have fly screens, blackout blinds, and forced ventilation slots.

Depending on the model, skylights can be opened upwards or placed in a diagonal open position.

ATTENTION



Material damage due to open windows or skylights when driving!

Open windows or skylights can hit signs, light poles, and other elements and cause severe damage to the vehicle and other property.

- Never drive with opened windows or roof canopies!

Models

Model variants



Fig. 35: Skylight 400x400 mm
VisionStar 700x500 mm



Fig. 36: Prop-up skylight



Fig. 37: Midi Heki / Mini Heki plus

Overview

5.1.9 Light in the entrance area



Fig. 38: Multifunction switch (example)

One or two switches are installed at convenient height in the entrance area. They control the various sources of light from inside and outside of the vehicle, permitting lighting the interior before entering the vehicle body.

5.1.10 Exhibition lighting (optional)

The vehicle is equipped with the light function referred to as “Exhibition lighting”.

By pressing the button for the awning lighting 10 times **at one-second intervals**, the exhibition lighting system is activated. This means that the base light (awning light, ceiling light, kitchen light, bathroom light) and the indirect lighting will automatically switch on again no later than 30 seconds after it has been switched off.

If it has been activated accidentally, it can be cancelled by pressing the awning lighting button 10 times again.

5.1.11 LED switches and LED displays (optional)

Dependent on the vehicle equipment, there are, in addition to the operating and control panel, other LED switches and LED displays, as shown in the overview:

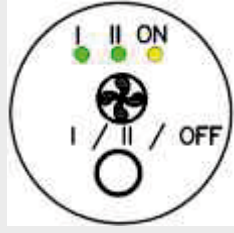
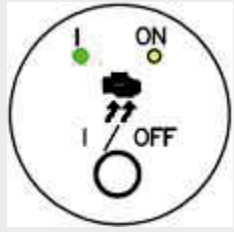
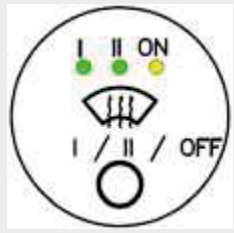
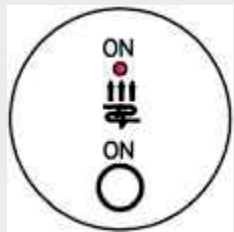
Figure	Description	Display
 <p>A circular control panel for the ALDE turbo convector. It features a fan icon in the center. Above the fan are three indicator lights: a green light labeled 'I', a green light labeled 'II', and a yellow light labeled 'ON'. Below the fan are three positions: 'I', 'II', and 'OFF', with a rotary switch below them.</p>	ALDE - Turbo convector with 2 fans	<ul style="list-style-type: none"> ■ Yellow = operating ■ 1 x green = fan at level I ■ 2 x green = fan at level II
 <p>A circular control panel for engine preheating. It features a lightning bolt icon in the center. Above the icon are two indicator lights: a green light labeled 'I' and a yellow light labeled 'ON'. Below the icon are two positions: 'I' and 'OFF', with a rotary switch below them.</p>	Engine preheating via ALDE heat exchanger	<ul style="list-style-type: none"> ■ Yellow = operating ■ 1 x green = pump operating
 <p>A circular control panel for windscreen heating. It features a fan icon in the center. Above the fan are three indicator lights: a green light labeled 'I', a green light labeled 'II', and a yellow light labeled 'ON'. Below the fan are three positions: 'I', 'II', and 'OFF', with a rotary switch below them.</p>	Windscreen heating via multivent	<ul style="list-style-type: none"> ■ Yellow = operating ■ 1 x green = fan at level I ■ 2 x green = fan at level II
 <p>A circular control panel for floor heating. It features a lightning bolt icon in the center. Above the icon is a red indicator light labeled 'ON'. Below the icon is another red indicator light labeled 'ON', and a rotary switch below them.</p>	Switch for floor heating	<p>On/Off switch:</p> <ul style="list-style-type: none"> ■ red = on

Overview

5.1.12 Smoke detector (optional)



Fig. 39: Smoke detector

A battery-operated smoke alarm is attached to the ceiling of the living area. If smoke develops in the vehicle, an acoustic alarm sounds warning the passengers of a possible fire.

The smoke alarm's integrated power supply via the installed 9V block battery ensures that the smoke alarm functions independently of the vehicle electrical system, and that it also operates when the vehicle's power supply is switched off.

- Prior to using the vehicle for the first time, remove the protective foil from the block battery to activate the smoke alarm.
- Regularly check the block battery and replace when necessary.

5.2 Furnishings

General

This section provides information about the functional areas within the motor home.

The design and configuration of the installed furnishings depend on the vehicle's model and the selected equipment.

Some features are available only upon a specific request and can only be installed if your order for the vehicle included such custom-made furnitures.

NOTICE



Fading of coverings, curtains, textiles and panelling in the vehicle can be easily and effectively prevented if upholstery and furnishings are protected from direct sunlight.

5.2.1 Seating and sleeping area

The shape and arrangement of the sitting area and table installed in the motor home depend on the model. Some vehicle models allow the tabletop to be lowered, which provides an additional sleeping arrangement.

Motor homes with rear external storage locker are equipped with a transverse bed or two single beds. The centre aisle in a layout with single beds can also be covered with a sliding panel and upholstery used to cover the gap. This creates a large enclosed sleeping area. A ladder or steps make access to the beds easier.

Under-the-bed storage

Storage compartments under the single beds are available for medium-sized luggage. Under-the-bed compartments can be reached via a hatch or by lifting and unfolding the slatted frame under the mattress.

Depending on the layout, with moving slatted frames, a gas pressure spring prevents folding down of the slatted frame after it has been deployed.

In order to fold down the slatted frame again:

- Press the red button and pushed down the bed simultaneously.

In motor homes with transverse beds, the storage space in a bench seat is available for loading, depending on the layout.

Overview

5.2.2 Bathroom

Washbasin



Fig. 40: Example of a washbasin

The washbasin, the shower, toilet are considered part of the bathroom area. Depending on the model and the selected features of the motor home washbasins, toilets, and showers can be either set up as a combination or installed separately in a different room. A large mirror is installed above the washbasin.

The bathroom is considered a high humidity area and must be aired using a mushroom-type vent, window, all a roof hood.

A hot water boiler and a mixer tap are used in the washing facility. The waste water is collected in the waste water tank.

Toilet



Fig. 41: Toilet

The toilet is installed next to the washbasin. The flushing water is taken from the fresh water tank. The flushing water and solid waste are accumulated in the waste holding tank.

- In order to empty in the waste holding tank, it must be removed from the toilet compartment on the outside of the vehicle.

NOTE



Waste water, solid waste and chemical substances can cause significant environmental damage.

- *Drain the waste water and solid waste tank only at designated disposal points.*

Shower stall



Fig. 42: Shower stall, example

Depending on the floor plan and selected equipment, the bathroom contains a shower. It is surrounded by a shower curtain or a shower door that keeps water inside the shower.

CAUTION



Material damage if the splash protection door is not locked in place when the vehicle is in motion!

If the splash protection door is not locked in place when the vehicle is in motion, it may swing open and destroy the bathroom fixtures.

- Prior to starting any trip and, ideally, immediately after each use, always secure the splash protection door with the provided fasteners!

The shower is supplied from the hot water boiler and features a mixer tap, storage shelf and towel holder.

Removable slatted floor (optional)



Fig. 43: Removable slatted floor

This visually appealing wooden floor insert protects the surface of the shower tray.

However, the insert can suffer from excessive moisture during showering and accumulate mildew. Remove the insert during showering or ensure the wood is oiled regularly (at least every six months) using linseed oil.

Linseed oil and similar products are available from specialist shops or DIY stores.

Overview

5.2.3 Kitchen area

Kitchen



Fig. 44: Kitchen base unit with cutlery drawer

The kitchen area is designed for longer stays. It includes a three-flame gas hob, sink and a small working surface. The gas cooker and sink are covered with safety glass panels.

There is a range hood above the cooking hob (optional), and above the hood there are cupboards for the crockery. A window provides sufficient fresh air while cooking.

Underneath the counter-top there are drawers for pots and pans, and cutlery. In some models, a refrigerator is also installed.

Large drawers may be loaded up to a maximum of 10 kg, smaller drawers can only be loaded with 5 kg.

WARNING



Risk of injury from flying crockery!

Flying crockery and hot cooking appliances can cause serious injury and material damage.

Before each journey:

- Turn off the gas cooker and shut off the gas supply.
- Safely store crockery and kitchen appliances.
- Close the glass panels and kitchen window.
- Lock the cabinets and drawers.
- Lock drawers.

Refrigerator



Fig. 45: Refrigerator (example)

The kitchen area includes the refrigerator, which, depending on the vehicle equipment, can be supplied with 12 V, 230 V, gas or a combination of different types of energy.

NOTE



Gas ignition at altitudes higher than 1000 m above sea level may be problematic - this is not a malfunction but a result of reduced atmospheric pressure.

The refrigerator works without any problem at inclines up to approximately 5°.

The refrigerator is designed to be flame-proof. The gas supply shuts off automatically if there is insufficient gas.

Overview

5.3 Storage compartments

5.3.1 Rear external storage locker

Large or bulky luggage, e.g. suitcases, can be easily stored in the external storage locker.

In order to attach larger components, movable lugs and tie-down hooks are provided in various locations.

The maximum load for the rear storage locker is 250kg, distributed over the entire surface.

NOTE



Depending on the features, motorhome equipment exists that requires access at all times, e.g., gas bottle locker, electrical connections.

WARNING



Danger of accident and injury due to unsecured packed goods!

Unsecured luggage and excessive load adversely affect driving behaviour; luggage can slide and cause serious accidents.

- Comply with the specifications for maximum permissible load.
 - Weigh luggage before loading and distribute weight uniformly.
 - Secure all luggage so that it cannot slip.
-

5.3.2 Wall cupboards

In contrast to cupboards or wardrobes and linen closets, the wall cupboard only offers stowage for light items. Please bear in mind the maximum load of 5 kg per compartment. They are fitted in various living areas.

Wall cupboards in the living area



Fig. 46: Wall cupboards in the living area

Additional storage possibilities are offered by the hinged compartments and open storage units e.g. above the sitting area as shown in the illustration.

This is a good place to store items of common interest, such as games, maps, or magazines.

Wall cupboards in the sleeping area



Fig. 47: Wall cupboards in the sleeping area

Hinged compartments are also installed above the beds; these compartments are primarily designed to hold useful accessories that are used daily such as towels and casual clothing.

Upper kitchen cabinet



Fig. 48: Upper kitchen cabinet, example

Small and medium-sized kitchen items such as crockery, plastic glasses, or cups are best stowed in the lockable storage units above the kitchen block.

Overview

Storage areas in the bathroom



Fig. 49: Cabinet compartments in the bathroom, example

Cosmetics, toilet and hygiene articles can be stored in the storage shelves, and upper and lower cabinets in the bathroom.

Additional storage space is provided by, for example, a mirror cabinet, if supplied with the model and selected equipment.

CAUTION



Damage due to unintended opening of the mirror cabinet doors during the trip!

Mirror cabinet doors can open on their own due to driving vibration and damage the fixtures in the bathroom.

- Prior to driving, lock the mirror cabinet door to prevent unintended opening of the doors.

5.3.3 TV bracket

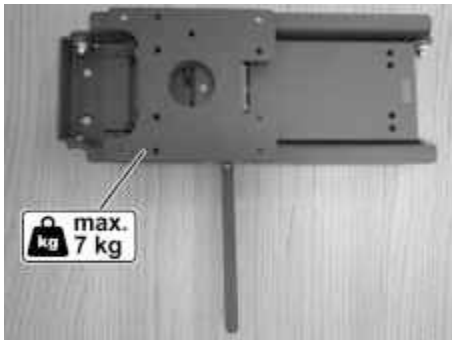

Fig. 50: TV wall mounting, example

A TV wall mounting is available for the safe carrying of a flat screen TV. The smooth-action lateral pull-out and the rotation function mean it is easy to move the TV into the desired position.

- Follow the manufacturer's instructions when mounting the TV on the retaining plate.
- The sprung steel lock must be moved left or right to unlock, depending on the seating. Simultaneously, pull the TV mounting unit to the desired length and, if necessary, adjust the angle of inclination.
- To lock the TV, position it vertically again. The TV must then be retracted as far as it will go until it clicks into place with an audible sound.

CAUTION



Damage to property due to falling TV!

While driving, the TV may fall down due to vibrations.

- Take down the TV before driving!

5.4 Technical equipment

General

Your motor home is equipped with modern and convenient technical systems. This section provides important information on the design and function of the equipment and built-in devices.

5.4.1 Electrical system

General

The electrical system of the motorhome is configured for 12 V and 230 V operation. For alternating operation of dual 12 V/230 V consumers, a charger is integrated on-board.

When the 230 V input of the motorhome is connected to an external 230 V supply network (e.g. via a camping site outlet), the dual devices are operated via the supplied power connection. The charger charges the supply battery. Once the battery is fully charged, the charger supplies a trickle charge to maintain a constant voltage.

Without an external power supply, the 12 V supply battery supplies power to all equipment in the motorhome.

DANGER



Life-threatening danger due to electric shock!

Danger of electric shock potentially resulting in serious or fatal injury when working on electrical equipment.

- Any repair tasks on the electrical system must be performed by qualified personnel.
- Replace defective fuses only after the cause of the fault has been identified and rectified.

Power connection



Fig. 51: Electrical connections

The connection to the 230 V power supply can be found outside the vehicle along the side wall.

The 3-pole CEE plug installed permanently in the motor home is used as connection.

NOTICE



Before travelling to foreign countries, obtain information about the plug and connector systems used at your destination. Suitable adapters are commercially available.

Overview

5.4.1.1 Supply battery

General

The supply battery is of AGM type.

The supply battery supplies all switched on 12 V devices when the system is not connected to an external power source. While this is the case, the supply battery is continuously discharging.

WARNING



Risk of injury due to improper handling of batteries!

Batteries can release toxic acid, explode and cause severe injury if handled improperly.

- The living space battery may only be disconnected, connected and replaced by specialist personnel.
- When replacing the living space battery, only use batteries of the same type and specification as the originally installed battery.
- Only use a different battery after approval by the vehicle manufacturer.

Battery compartment

The seat console underneath the front passenger seat has space for up to two supply batteries. As standard, each vehicle is equipped with one battery which is also secured with a 50 A fuse.

AGM battery

AGM batteries do not contain free sulphuric acid and can be operated in any position. The acid cannot escape even if the AGM battery breaks.

The list below provides a summary of the advantages of an AGM battery:

- Low maintenance (closed system)
- High cycle stability, long service life
- Low spontaneous discharge, long storage life
- Leak-proof/no gas formation/no corrosion/no drip tray
- High shock and vibration resistance

After its initial operation, the AGM battery must be recharged monthly. Depending on the outside temperature and the actual amount of discharge, the charging intervals can be adjusted individually.

Battery charge status**CAUTION****Explosion hazard due to overcharging!**

A defective charger can cause "boiling" of the supply battery and an explosion.

- Switch off the charger immediately if the battery is boiling.
- Have the defective charger repaired by an authorised specialist workshop or replace with a new unit.

CAUTION**Material damage due to deep discharge!**

If a deep discharge occurs, batteries (regardless of battery type) can be permanently damaged or destroyed.

- Avoid a low battery charge, this is indicated by a low voltage.
- Checking the voltage regularly is recommended.

CAUTION**Material damage due to improper maintenance!**

Improper maintenance of the battery will cause destruction and total failure of the unit!

- Comply with manufacturer instructions.
 - Travel only with fully charged battery.
 - After every trip, recharge the battery for 12 hours.
 - Batteries subject to high ambient temperatures (≥ 30 °C) require more frequent recharging.
 - At shut-down times of more than four weeks, disconnect the batteries from the on-board system and recharge on a monthly basis.
 - Check the acid condition at least once a year (only in lead-acid battery).
-

Overview

The charge status can be read from the operating and control panel. The displayed voltage is interpreted as follows. The values apply to when the vehicle is running, not open-circuit voltage.

Battery voltage	Battery operation Vehicle is parked, no 230 V connection	Vehicle operation The vehicle is moving	Mains operation Vehicle is parked, 230 V connection
Less than 11.5 V	if consumer is disconnected: Battery empty	Charging with the alternator is not possible	Charging with the EBL power supply not possible ¹⁾
Risk of deep discharge	if multiple consumers are switched on: Possible overloading of the battery	12 V on-board system overloaded	12 V on-board system overloaded
12.2 V to 12.7 V	Normal range	Charging through the alternator not possible ¹⁾	Charging with the EBL power supply not possible ¹⁾
		12 V on-board system overloaded ¹⁾	12 V on-board system overloaded ¹⁾
13.5 V	Only occurs during charging (only if solar regulator present) or briefly after charging	Battery is being charged	Battery is being charged

¹⁾ if the voltage does not exceed this range for several hours.

Charging via a 230 V power supply

If an external 230 V power supply is connected, the integrated charger charges the supply and starter battery. A trickle charge (2 A) supplies the starter battery with power. The charging current is adjusted to the charge status. Overcharging is not possible.

To exploit the full capacity of the charger, switch off all electrical consumers during the charging process.

Using the vehicle's engine for the charging process

While the vehicle's engine is running, the alternator charges the supply batteries.

When the vehicle's engine is switched off, a relay automatically disconnects the supply batteries from each other. This prevents the electrical consumers that are currently switched on in the motorhome from discharging the starter battery. Thus, the starting capacity of the motorhome is maintained.

When using the alternator to charge the battery during the journey, this is a supplementary process that helps recharging the battery instead of using an external 230 V power connection.

5.4.1.2 Lay-up

A lay-up is implemented to protect the supply battery against deep discharge.

Preparing for lay-up:

1. Switch off the 12 V main switch on the operating and control panel
2. Set the battery isolating switch to the "Battery Off" position.

All 12 V consumers are disconnected from the living space battery.

The operating and control panel is likewise switched off.

The battery alarm is no longer active. However, the living space battery can still be charged via the internal charging module provided there is an external 230 V connection.

Ending a temporary lay-up:

1. Set the battery isolating switch to the "Battery On" position.
2. Switch the 12 V main switch on the operating and control panel back on

All 12 V consumers are ready for operation again.

The operating and control panel can be used again.

The battery alarm is active again.

NOTE



Fully charge the living space battery prior to lay-up!

CAUTION



Fire danger due to heat accumulation!

The supply battery and the Elektroblok become hot during operation which can result in smouldering or fire if the heat dissipation is inadequate.

- Never cover the supply battery or the Elektroblok.
- Do not misuse the storage space of the supply battery and the Elektroblok as a storage space for other objects.

Overview

5.4.1.3 Operating and control panel LT 460 A

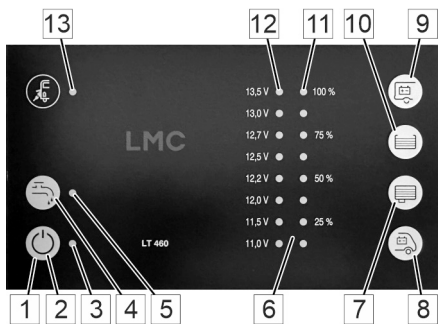

Fig. 52: Operating and control panel LT 460 A

The following settings and display options are provided on the operating and control panel:

- 1 Sensor buttons**
- 2 Main switch 12 V on/off:**
Switching the vehicle's 12 V supply on and off
- 3 Main control switch indicator LED (green):**
Indicator: 12 V vehicle supply switched on
- 4 Pump switch:**
Switching on or off of the 12 V supply to the water pump
- 5 Pump switch LED indicator (yellow):**
Indicator: Pump supply switched on
- 6 Indicator elements**
- 7 Query Waste water tank level**
- 8 Query Starter battery voltage**
- 9 Query Living space battery voltage**
- 10 Query Water tank level**
- 11 8 LEDs (blue):**
Display of the tank filling levels of water and waste water tanks in four levels.
- 12 8 LEDs (2 red - 2 yellow - 4 green):**
Battery voltage display in 8 levels and warning of deep discharge.
- 13 LED mains power indicator (yellow):**
The LED comes on if the mains voltage is switched through at the input to the vehicle's mains supply

General information on operating sensor buttons

The operating and control panel LT 460 A is equipped with touch-sensitive sensor button fields. These fields react to touch with a bare finger. If gloves are worn (e.g. when camping during winter), the operating and control panel LT 460 A cannot detect the contact. Therefore, gloves must be removed before operation.

NOTE



For detailed information, refer to the operating instructions of the relevant manufacturer!

Start-up

1. Switch on the operating and control panel LT 460 A (see the following section).
2. Connect the input for the vehicle's mains supply to the 230 V mains supply.

LED mains power indicator comes on. The living space battery is charging.

Switching on

The 12 V vehicle supply is switched on via the corresponding button. This does not include the refrigerator control. It remains operational, even when the 12 V supply is switched off:

1. Touch the sensor button "Main switch 12 V ON / OFF".

The green indicator LED comes on.

The 12 V supply of the living space is switched on.

Switching the water pump on and off

The power supply to the water pump can be switched on and off via the operating and control panel LT 460 A:

1. Touch the corresponding sensor button.

The yellow indicator LED comes on.

The corresponding supply voltage is switched on.

2. Touch the corresponding sensor button again.

The yellow indicator LED goes out.

The corresponding supply voltage is switched off.

NOTE



When the water pump supply is switched on, a pressure pump may, if connected, start up briefly.

Battery type and capacity of the living space battery

NOTE



The battery type is set in the factory.

Overview

Querying tank levels

1. Touch the corresponding sensor button.

The filling level of the corresponding tank is displayed (for as long as the sensor button is being touched):

- Water: 100%, 75%, 50%, 25%;
if the 25% LED flashes after querying, the tank is empty.
- Waste water: 100%, 75%, 50%, 25%

Tank filling mode

In tank filling mode, the values are continuously displayed for a certain duration (water 5 min, waste water 3 min) and queried in real time. This allows the level to be continuously checked during filling or emptying of the tank.

1. Briefly sequentially touch the corresponding sensor button twice.

The respective tank filling mode is enabled - the values are continuously displayed and updated in real time.

2. Briefly touch the corresponding sensor button once.

Tank filling mode is exited.

NOTE



Tank filling mode is automatically exited after 3 respectively 5 min has elapsed.

5.4.1.4 Interior lighting

LED spotlight



Fig. 53: LED spotlight

In the interior, there is a rotating and swivelling 12 V LED gooseneck above the seating area and in the sleeping area, which ensures good illumination of the seats (for use see → "Arranging the lights" section).

Each spotlight has its own ON/OFF switch on the back and 2 USB-A sockets at the base of the light.

The lighting fixtures are switched via power circuits 1 and 2. If the power circuits are disconnected, the spotlights cannot be used.

Room spotlights

Depending on the model and the selected equipment, there are either room spotlights with multiple rotating and pivoting LED lamps on a rail system, or permanently installed lights in the canopy. These are activated by a central ON/OFF switch. The light intensity can be regulated.

Overview

Bathroom lighting



Fig. 54: Bathroom lighting, example

In the illustration on the left-hand side, the LED lights are installed in the bathroom above the mirror of the washbasin. These lights are also switched via lighting circuits 1 or 2. They can be operated if the lighting circuits are enabled.

Kitchen light

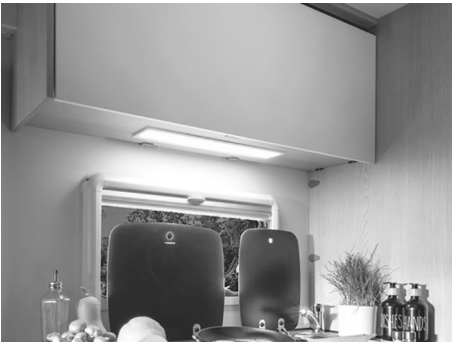

Fig. 55: LED light rail (typical)

There is an LED light rail in the kitchen area below the top cabinet, which can be switched on and off via an ON/OFF switch.

Canopy light (optional)

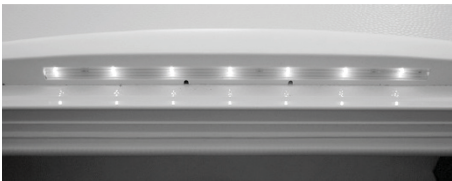

Fig. 56: Canopy light with LEDs

The awning light (optional) lights up the entrance area at night. It can be operated with the remote control unit (optional) or the corresponding button on the entry door.

The awning light must always be operated manually. For safety reasons, it does not switch off automatically and remains in operation until it is switched off.

NOTE



The canopy light is not a headlight authorised for traffic and must be switched off before driving!

5.4.1.5 Power outlets

230V outlet



Fig. 57: 230 V outlet, example

Outlets for the connection of small appliances when an external power supply is connected can be found at various locations in the vehicle interior, depending on the model and selected equipment (the picture shows an outlet in the support of the sitting area).

12 V socket (optional)



Fig. 58: 12 V socket, example

If a TV wall mounting is fitted, a 12 V socket will also be installed for powering the TV from alternate voltages.

USB socket (optional)



Fig. 59: USB socket, example

Depending on the vehicle's equipment level, a USB socket will also be available in the vehicle.

Overview

5.4.2 Gas supply

General

This section provides information about the gas supply system in the vehicle.

Depending on the model and the selected vehicle equipment, the following appliances are connected to the gas system: Heater, boiler, baking oven, cooker, grill, refrigerator or the cooling/freezer cabinet combination. A detailed description of these appliances can be found in the attached documentation.

- Prior to using the integrated gas equipment, all safety and operating instructions found in the relevant manufacturer's operating manuals must be read and observed!

WARNING



Danger of explosion and injury due to gas!

Escaping gas can cause poisoning and explosions.

- All repairs on the gas system must be performed only by authorised specialist personnel.
 - If gas odour is detected:
 - Immediately shut down the gas supply.
 - Do not operate any electric devices.
 - Remove fire and sources of ignitions.
 - Do not smoke.
 - Have gas system repaired immediately.
-

Gas locker



Fig. 60: Example of a gas bottle locker

Depending on the model and the selected vehicle equipment, the gas bottle locker can be found along the side of the motor home or the rear of the vehicle. A safety strap to secure the gas bottle is installed inside the locker. If necessary, and dependent on the model, a second gas bottle safety strap can be retrofitted.

The gas bottle locker also contains a gas hose with a flange connection for the gas bottle.

- Only tighten the gas pressure control valve manually – never attempt to use a tool or other instruments – otherwise, the seal may be damaged. The connection uses a left-handed thread!
- The valves of all gas bottles carried inside the vehicle must be closed prior to fuelling and other extended stays (e.g., when not using the motor home).

Gas locker



Fig. 61: Example of a gas bottle locker

Depending on the model and the selected vehicle equipment, the gas bottle locker can be found along the side of the motor home or the rear of the vehicle. A safety strap to secure the gas bottle is installed inside the locker.

The gas bottle locker also contains a gas hose with a flange connection for the gas bottle.

- Only tighten the gas pressure control valve manually – never attempt to use a tool or other instruments – otherwise, the seal may be damaged. The connection uses a left-handed thread!
- The valves of all gas bottles carried inside the vehicle must be closed prior to fuelling and other extended stays (e.g., when not using the motor home).

Overview

Quick-closing valves

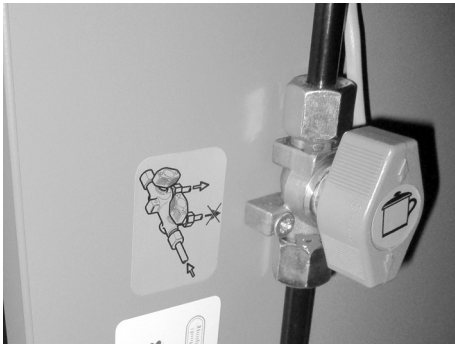

Fig. 62: Quick-closing valves

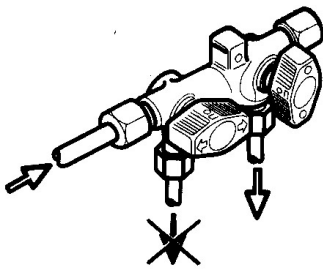

Fig. 63: Shut-off and release position

The quick-action valves for the gas appliances are located in the caravan body, either in the drawer under the counter-top (as shown in the figure.) or in the lower cabinet in the kitchen. The quick-closing valves must be accessible at all times.

Each gas appliance has its own quick-action valve.

The arrow on the quick-action valve indicates whether gas flow to the gas appliance is open or shut off.

The quick-action valves are marked as follows:

Symbol	Meaning	Symbol	Meaning
	Hob		Hot water boiler
	Oven		Heater

- Always close the quick-action valves prior to fuelling, and after using the gas appliance!

Gas supply with low pressure regulator and low pressure hose



Fig. 64: Gas bottle with low pressure regulator and low pressure hose

For connection of a gas bottle, a flexible gas hose with pressure reducing valve is installed. The pressure reducing valve is fitted with a sleeve nut with left-hand thread, and should only be screwed hand-tight with the gas bottle. Gas hose and pressure reducer must be examined for leaks at each gas test, and replaced if the status is deficient, at the latest, however, the gas hose and pressure reducer must be replaced at the end of the permissible service life.

- Place the gas bottle in the gas locker and lash the bottle tight with the securing belt.
- Screw the pressure reducing valve directly onto the thread of the discharge valve on the gas bottle and hand tighten.

5.4.3 Heater

A hot water heater (TRUMA Combi-D heater) is provided as standard for heating the motor home using diesel.

Prior to using the equipment, the safety and operating instructions provided with the equipment manufacturer's operating manual must be read!

5.4.3.1 TRUMA Combi-D heater (optional)



Fig. 65: TRUMA Combi-D heater

The combi heater is responsible both for heating and for the supply of domestic hot water.

The heater generates hot air that is distributed in the caravan interior via a hot-air pipe system.

The integrated DHW generator supplies the sink and washbasin taps plus the shower head in the shower stall.

Summer or winter operation is available as an option.

Overview

TRUMA operating unit for heater and hot water



Fig. 66: TRUMA operating unit for heater and hot water preparation

The TRUMA operating unit can be found in the interior above the entrance. There is a rotary knob (black) in the centre of the unit that is used to control the temperature. The outer ring (grey) is used to select the operating mode of the hot water heater.

When turning the unit on, an option is provided to select between different operating modes, e.g., summer operation or winter operation.

When selecting the summer operation (the position 3, 4), the heater is not active, the water temperature is pre-selected between two settings.

During the winter operation (position 6, 7), the heater is activated and the hot water supply can be selected or deselected.

In the switches and the symbols have the following meanings:

- 1 Heater rotary knob (room temperature)
1 = low heat ... 5 = high heat
- 2 Rotary ring for the operating mode of the hot water heater
- 3 Summer operation, water temperature 60°C
- 4 Summer operation, water temperature 40°C
- 5 Boiler "OFF", heater and hot water are not available
- 6 Winter operation, heating only, without hot water supply
- 7 Winter operation, heater with hot water supply

The indicator lights signal the operating mode of the boiler:

Indicator light	Operating mode
yellow	Hot water heater in heating phase
green	Heater on
red	Fault

- Prior to operating any equipment, reading the detailed safety and operating instructions contained in the operating manual of the relevant manufacturer is mandatory!
- If a malfunction occurs, always check the gas bottle valve and the quick-action valve first, ensuring that both are open. The safety relief valve must be closed and the water level must be sufficient.
- If the flaw cannot be repaired, contact the nearest specialist a workshop!

Digital TRUMA control unit CP plus

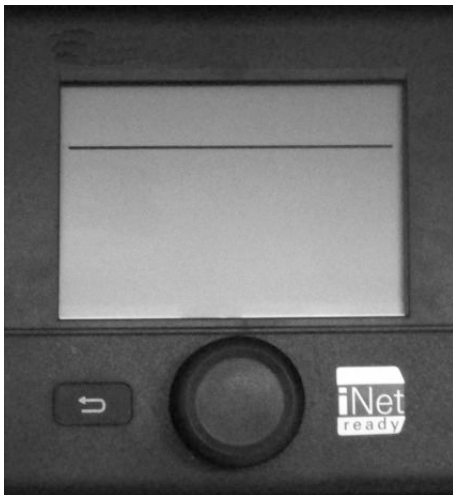

Fig. 67: Digital TRUMA control unit CP Plus

- Central control unit for the TRUMA Combi CP plus ready and a TRUMA air conditioning system
- Boost function for fast hot water supply and heating of the area
- All functions are programmable using the timer
- Individual temperature settings based on the time – for a comfortable and quiet night

It serves as an interface for the operation of connected devices via TRUMA App and iNet Box.

Detailed instructions can be found in the operating manual provided by the manufacturer.

Hot-air nozzle



Fig. 68: Hot-air nozzle, open

To heat the caravan body, the blower drives hot air through the hot-air piping and expels the air through the hot-air nozzles into the caravan interior.

To regulate the flow of hot air as needed, the hot-air nozzles installed at various points can be manually opened or closed.

- To open and close bring the revolving dampers of the hot-air nozzles into the desired position.

Overview

String-operated baffle (optional)

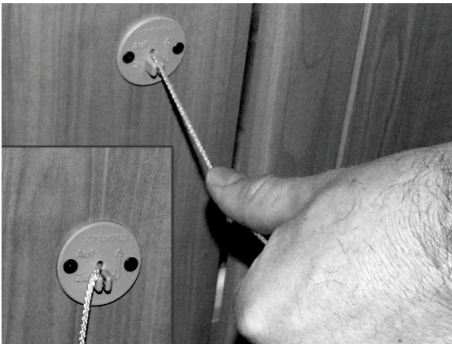

Fig. 69: String-operated baffle

In some areas of the vehicle where continuous warm air supplied is not required or wanted during the heating operation, string-operated baffles can be used to block the warm air supply. Depending on the model and selected equipment, these areas include: External storage locker, alcoves, toilet, fresh water and waste water tank areas.

- Closing the string-operated baffle: Pull the string out and fasten it to the clip.
- Opening the string-operated baffle: Release the string from the clip.

Wall exhaust stack



Fig. 70: Wall exhaust stack

The wall exhaust stack routes the exhaust gases resulting from space heating or DHW heating into the external atmosphere. Depending on model and selected equipment, it is located on the left or right side of the vehicle.

The opening must always be free and clean to ensure unobstructed discharge of the exhaust gases.

NOTE



Never use the cover as a clothes hook or to fasten objects!

Always keep the opening free of leaves, dirt, and other fouling!

5.4.3.2 Heat the floor with hot water (optional)

A pipe system laid out under the floor with thermally conductive layers arranged on top serves as the floor heating system (optional). A special heating fluid (glycol/water mixture) circulates through the pipe system.

- In combination with the TRUMA Combi heater, the heating fluid is heated in a separate thermal unit. Here, the hot air generated in the gas heater is channelled through the thermal unit. To accelerate the heating process, the 230 V heating element integrated in the thermal unit can be switched on.
- In combination with the ALDE heater, the floor heating system represents an additional heating element in the heating circuit.

CAUTION



Danger of damage to the pipes in the floor!

Screws, nails, and other fastening material can damage the pipes in the floor and cause the heating fluid to escape.

- Do not retrofit, convert, or add individual installations in the living area.
- Never use screws, nails or other fasteners in the floor.
- Do not damage the floor surface.

NOTE



All claims are excluded for damage to the pipe system, consequential damage to the caravan body or fixtures and fittings due to installations in the floor

Function switch of the floor heater system

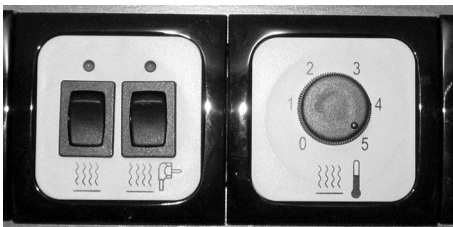

Fig. 71: Function switch (example)

In combination with the TRUMA Combi heater, the function switches for floor heating are located above the entrance door.

Overview

5.4.4 Fresh water and waste water system

In LMC motorhomes, the fresh and waste water tanks are installed under the floor and optionally can also be equipped with an insulation box. A precise overview of the respective filling levels can be obtained by querying the operating unit.

With the LMC Tourer, the valves are arranged in a decentralised manner.

With the LMC Cruiser, the valves are arranged centrally on the left side of the vehicle in the service compartment.

5.4.4.1 Fresh water tank

Fresh water filler neck



Fig. 72: Fresh water filler neck

The fresh water tank is filled via the fresh water filler neck. It is located on the exterior side wall of the vehicle. All valves must be closed prior to filling.

CAUTION



Risk of poisoning!

Only small drops of fuel can contaminate the fresh water and cause severe health hazards.

- Never confuse the fuel tank lid with the fresh water filler neck!

Filling level-pre-setting and draining of the fresh water tank are possible directly at the tank via the combination drain valve. The cleaning opening and the knurled screw of the combination drain valve are accessible after removal of the floor flap.

5.4.4.2 Waste water tank

NOTE



Cleaning agents, soaps and cosmetics contaminate the environment and ground water.

- *Never drain waste water in free nature, dispose only at the designated disposal points.*

The waste water from sink and washbasin drains via a waste pipe directly into the waste water tank. Therefore, before travelling always close the waste water drain cock.

If the tank is full, please drive to a motorhome wastewater disposal point to drain the grey water.

To clean the waste water tank, please use a cleaner from the camping accessories range.

5.4.4.3 Drain valves for fresh water and waste water system

Drain valves

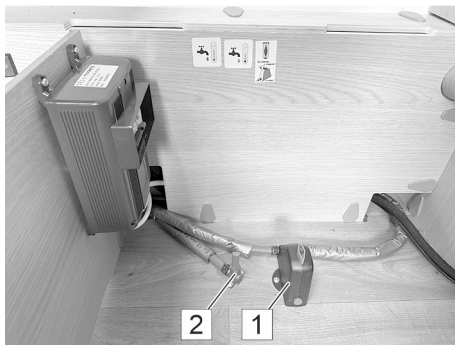

In the LMC Alkoven, the valves are installed as follows:

- 1 Safety drain valve for water in the boiler and the inlet upstream of the boiler
- 2 Manual drain valve for water from the circuit behind the boiler
- 3 Drain valve for waste water (grey water) via a linkage assembly below the vehicle that opens the ball valve by actuating the rotary knob

Fig. 73: Drain valves

Camping

6 Camping

This section describes the operation and function of the equipment of your caravan. See also the instructions provided in the "Overview" section and those in the operating manuals for the built-in devices.

6.1 Equipping the camper

6.1.1 Establishing the power connection



Fig. 74: Power connection

1. Before connecting, check whether the electrical supply mains matches the power specification of the motor home.
2. When using cable drums, completely unroll the power cable to prevent the cable from overheating.
3. Lay the cable so that it does not cause a stumbling hazard; mark the cable routing, if necessary.
4. Connected the power cable with the permanently installed CEE socket.
5. Connect the plug of the power cable to the external supply station.

6.1.2 Filling the fresh water tank

WARNING



Health hazard due to germs and bacteria in the drinking water!

Contaminated drinking water can cause serious infections.

- Prior to the first use, disinfect the fresh water system of the vehicle, and thoroughly flush with drinking water.
- Transfer water only from supply systems with proven drinking water quality.
- Filling hose and container must be approved for drinking water.



Fig. 75: Fresh water intake port

1. Open the fresh water intake port.
 - Hold the twist cap firmly with one hand, insert the caravan body key into the lock and turn the key 180°.
 - When the lock is unlocked, press the twist cap and turn it 120° anticlockwise.
 - Subsequently, remove the twist cap.
2. Prior to refilling, drain the remaining water from the fresh water tank and thoroughly flush it.
3. Before using the filling holes ensure to to rinse it with 2 to 3 times the volume of the tank.
4. Insert the filling hose into water intake port and fill the tank with fresh water.

NOTICE



The knurled thumb screw of the overflow valve must be closed in order to utilise the full capacity of the freshwater tank.

5. Thoroughly flush out all lines. To do this, first, open all drain valves, ensure to rinse them thoroughly and closed the valves again.
6. Turn on the water pump, turn the mixer tap first into the warm water position, then open the cold water position, rinse well and close again.
7. After filling of the freshwater tank is completed, remove the filling hose and close the freshwater intake port.
 - Insert the twist cap with the pins in the grooves of the fresh water intake port.
 - Press the twist cap and turn it clockwise 120°.
 - Turn the key in the lock 180° clockwise and withdraw the key.
8. Finally, empty the filling hose and cap the ends.

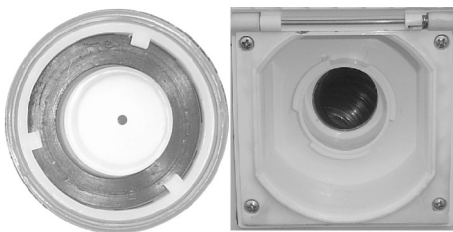

Fig. 76: Twist cap (left), fresh water intake port (right)

Camping

6.1.3 Drawing fresh water

Mixer tap



Fig. 77: Mixer tap

WARNING



Danger of scalding due to hot water!

Hot water can scald hands and other body parts.

- Open the mixer tap in cold-water position and carefully raise the temperature.

1. To obtain water, turn the lever in direction of the cold-water setting (blue mark), lift upward, and slowly shift in direction of the red mark.
2. To close, turn the mixer lever in direction of the blue mark and push downward.

6.1.4 Emptying the fresh water tank

Fresh water tank with combination drain valve

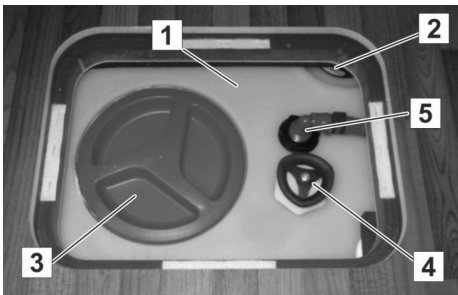

Fig. 78: Layout underneath the floor

- 1 Fresh water tank
- 2 Filling level sensor
- 3 Cleaning cover
- 4 Knurled thumb screw for combination drain valve
- 5 Water pipe

The fresh water tank is located in the rear storage locker. Combination drain valve and cleaning opening of the fresh water tank are visible after removal of the service cap in the rear storage locker.

NOTE



Standing water in the fresh water tank becomes unfit for consumption, even after a short period. Therefore, prior to using the system again, a suitable cleaning agent and disinfectant, available at all speciality stores, must be used to flush the fresh water tank and pipelines thoroughly.

Combination drain valve

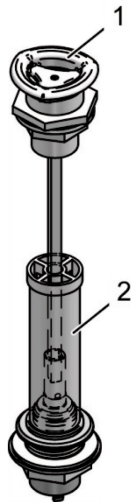

Fig. 79: Combination drain valve

Use of the knurled thumb screw (1) on top of the fresh water tank to operate the combination drain valve. The knurled thumb screw is used for the easy control of the freshwater tank filling level. When using the knurled thumb screw, the filling level of the fresh water tank can be individually adjusted by changing height of the drain (2). When opening the combination drain valve, the filling volume of the water tank is reduced. By using this procedure, the payload of the motor home can be increased, e.g., taking additional luggage on your journey.

When arriving at the destination, the knurled thumb screw can be closed again to utilise the entire tank volume and to fill with fresh water.

- To open the combination drain valve, turn the knurled thumb screw (1) anticlockwise.

NOTE



To allow the tank and the lines to be completely emptied, the mixing valves in the kitchen and bathroom must also be opened and turned to the middle position.

- To close the combination drain valve, turn the knurled thumb screw (1) clockwise.

Rotating position of the knurled thumb screw	Operating position of the combination drain valve	Filling level of fresh water tank
Left end stop	opened	Fresh water tank is emptying
In the centre between left/right to limit stop	Half opened	The max. volume of the freshwater tank is approx. 20 litres
Right end stop	Closed/only for overflow function	The max. volume of the freshwater tank is approx. 100 litres

ATTENTION



Damages after extended stand time or frost!

If the vehicle is not used in winter, the sanitary system may be damaged due to frost.

Extended stand times can cause algae growth in the sanitary system.

- Ensure that the overflow valve is free from contamination and ice formation.
- In the event of frost or extended stand time, completely empty the water tanks, containers, hoses, and conduits. Dry-run the pump for approximately five minutes to avoid frost damage caused by residual water in the pump.

NOTE



Frost damage or contamination caused by algae growth in the water system are not covered by the guarantee!

6.1.5 Emptying the waste water tank

Open the grey water valve of the LMC Tourer

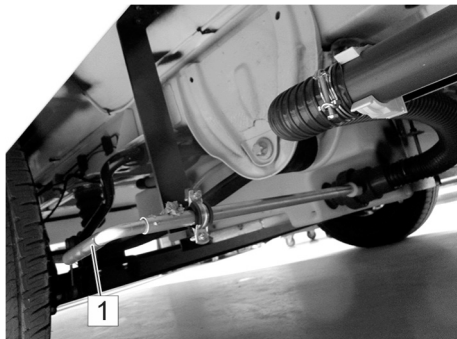

Fig. 80: Linkage assembly for drain valve, example

- Insert handle (1) and activate swivel lever.

Waste water outlet

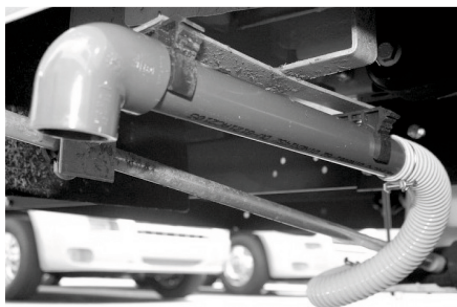

Fig. 81: Drainage outlet, example

The waste water drainage outlet can be found underneath the vehicle's floor. The pipe is clamped into a plastic bracket.

- To drain the waste water, remove the drainpipe from the bracket and rotate it towards the canalisation.

NOTE



Cleaning agents, soaps and cosmetics contaminate the environment and ground water.

- *Never drain waste water in free nature, dispose only at the designated disposal points.*

Camping

6.1.6 Changing the gas bottle

- For the standard model of the gas system (flexible gas hose and pressure reducer) change the gas bottle as follows:

WARNING



Danger of explosion and injury due to gas!

Escaping gas can cause poisoning and explosions.

- All repairs on the gas system must be performed only by authorised specialist personnel.
 - If gas odour is detected:
 - Immediately shut down the gas supply.
 - Do not operate any electric devices.
 - Remove fire and sources of ignitions.
 - Do not smoke.
 - Have gas system repaired immediately.
-



Fig. 82: Gas bottle locker



Fig. 83: Gas bottle with pressure reducing valve

1. Open the gas locker.
2. For changing an empty gas bottle, close the valve at the empty bottle.
3. Manually unscrew the union nut of the gas bottle valve (note the left-handed thread).
4. Loosen the fastening belt of the gas bottle and remove the bottle from the gas locker.
5. Inspect the gas hose. If it is porous or damaged, have it replaced by qualified personnel.
6. Place the new gas bottle in the locker and secure with fastening belts.
7. Manually screw the cap nut of the pressure reducing valve tightly onto the gas bottle valve.
8. Close the gas locker and engage the lock.
9. In order to operate the gas appliances, open the gas bottle valve and the applicable quick-action valve.

6.1.7 Gas supply maintenance (general)

- Repeat the gas supply inspection pursuant to applicable regulations (every two years in Germany, for example).
- Replace the gas pressure regulator set and the hoses at the latest ten years after their manufacturing dates.

Camping

6.2 Airing

General

Regular and planned airing of the caravan creates a pleasant atmosphere and prevents condensation formation and heat built-up.

Use the hinged windows, sliding windows and skylights to air the motor caravan superstructure.

The caravan features forced ventilation openings to ensure continuous airing.

ATTENTION



Damage due to inadequate ventilation!

Inadequate ventilation causes a lack of oxygen and worsens the room climate. Heat accumulation and water condensation cause damage to the interior furnishings.

- Never cover the louvres for forced ventilation.
Always ensure adequate airing of the vehicle.



Fig. 84: Hinged window

Intensive airing

1. Turn the rotating knob upward by approximately 90°.
2. Swing the window outward and latch in the desired position or fasten with the locking mechanism.
3. To close the hinged window, swing further upward or undo the locking mechanism.
4. Swing the hinged window backward, close it and lock with sash fastener.



Fig. 85: Continuous ventilation

Continuous ventilation

1. Turn the rotating knob upward by approximately 90°.
2. Push the window outward by approximately one to two centimetres (one inch).
3. Turn the rotating knob back in order for the locking catch to insert in the recess of the window latching mechanism.

Close:

4. After airing, turn the rotating knob again upward until the locking catch can leave the recess.
5. Pull the window into the frame. To lock, turn the rotating knob downward by approximately 90°.



Fig. 86: Prop-up skylight

Opening the prop-up skylight

1. Grasp both handles to push the internal locking levers.
2. Grasp both handles and push the skylight upward.

Closing the prop-up skylight

1. Grasp both handles to push the internal locking levers.
2. Grasp both handles and pull the skylight downward.



Fig. 87: Operating the Skylight
400x400 mm /
VisionStar 700x500 mm

Opening the skylight

1. With the VisionStar, pull and/or turn the handle down so that the skylight unlocks.
2. Push the pulled down handle forwards so that the skylight lifts up.
3. Latch the clip in the desired position.

Closing the skylight:

- Move the handle back from the latched position into the initial position.

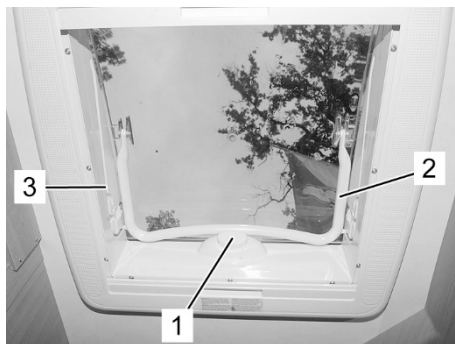

Fig. 88: Operating the Midi Heki / Mini Heki plus

Opening the skylight

1. Press the safety button (1) of the skylight.
2. Move the clip (2) in the guide groove (3) backward.
3. Latch the clip in the desired position.

Closing the skylight:

- Move the clip from the latching position back to its original position until the safety button (1) locks the skylight.

Camping

Skylight combination blind



Fig. 89: Example of a skylight combination blind

The skylights in the living area and bedrooms (not in the toilet) are fitted with blackout blinds and a fly screen.

For both blinds:

1. To close the blind, pull it into the desired position.
2. To open the blind, slide it into the end position.

Door blind



Fig. 90: Door blind

The window in the entrance door is equipped with a door blind.

1. To close the door blind, slide the handle into the desired position.
2. To close the blind, slide the handle back.

Combination blind



Fig. 91: Combination blind

The hinged windows are fitted combination blinds consisting of a fly screen and a blackout blind. Both blind components are hung from the window top.

For both blinds:

- To close, use the handle to pull the fly screen fully downward and slightly push against the window until the lower strip latches.
- To open, push the handle downward and slightly pull toward yourself until the lower strip detaches. Due to the tension, the blind automatically rolls up – hold the handle during this action.

The blackout blind can be lowered in three different heights. It latches in one of three possible positions in the lateral guide rails.

ATTENTION



Damage to the blinds if they fly up!

To avoid damage to the blind, ensure that the blind CANNOT fly up.

NOTE



Do not keep the blind closed during driving and over a longer period of time (several weeks).

Over time, the springs would suffer if the blinds are permanently lowered.

Re-tensioning the blinds

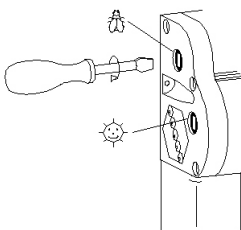

Use a screwdriver to re-tension the blind springs.

- Insert the screwdriver and turn once or twice clockwise.
- Check the tension and repeat the process, if required. Ensure that you don't over-tension the springs.

Blind care

As a rule, never use aggressive cleaning agents (solvents or abrasives). Use a damp cloth and soapy water to clean the blinds and frame parts. Use a soft brush and/or damp cloth to clean the fly screen.

Camping

6.3 Heating and water heating

6.3.1.1 TRUMA Combi-D heater (optional)



Fig. 92: TRUMA Combi-D heater

The combi heater is responsible both for heating and for the supply of domestic hot water.

The heater generates hot air that is distributed in the caravan interior via a hot-air pipe system.

The integrated DHW generator supplies the sink and washbasin taps plus the shower head in the shower stall.

Summer or winter operation is available as an option.

TRUMA operating unit for heater and hot water

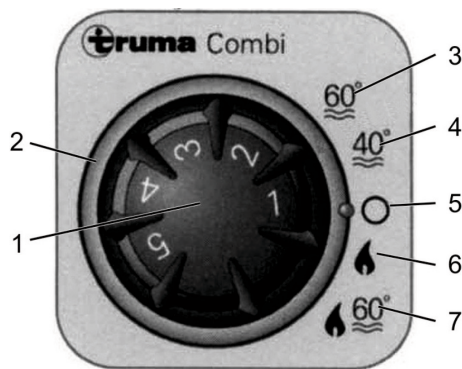

Fig. 93: TRUMA operating unit for heater and hot water preparation

The TRUMA operating unit can be found in the interior above the entrance. There is a rotary knob (black) in the centre of the unit that is used to control the temperature. The outer ring (grey) is used to select the operating mode of the hot water heater.

When turning the unit on, an option is provided to select between different operating modes, e.g., summer operation or winter operation.

When selecting the summer operation (the position 3, 4), the heater is not active, the water temperature is pre-selected between two settings.

During the winter operation (position 6, 7), the heater is activated and the hot water supply can be selected or deselected.

In the switches and the symbols have the following meanings:

- 1 Heater rotary knob (room temperature)
1 = low heat ... 5 = high heat
- 2 Rotary ring for the operating mode of the hot water heater
- 3 Summer operation, water temperature 60°C
- 4 Summer operation, water temperature 40°C
- 5 Boiler "OFF", heater and hot water are not available
- 6 Winter operation, heating only, without hot water supply
- 7 Winter operation, heater with hot water supply

The indicator lights signal the operating mode of the boiler:

Indicator light	Operating mode
yellow	Hot water heater in heating phase
green	Heater on
red	Fault

- Prior to operating any equipment, reading the detailed safety and operating instructions contained in the operating manual of the relevant manufacturer is mandatory!
- If a malfunction occurs, always check the gas bottle valve and the quick-action valve first, ensuring that both are open. The safety relief valve must be closed and the water level must be sufficient.
- If the flaw cannot be repaired, contact the nearest specialist a workshop!

Digital TRUMA control unit CP plus

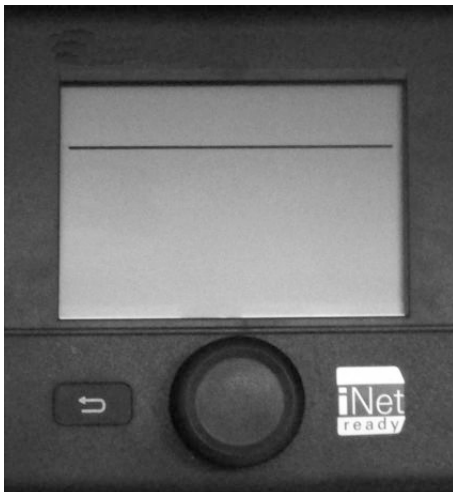

- Central control unit for the TRUMA Combi CP plus ready and a TRUMA air conditioning system
- Boost function for fast hot water supply and heating of the area
- All functions are programmable using the timer
- Individual temperature settings based on the time – for a comfortable and quiet night

It serves as an interface for the operation of connected devices via TRUMA App and iNet Box.

Detailed instructions can be found in the operating manual provided by the manufacturer.

Fig. 94: Digital TRUMA control unit CP Plus

Camping

Display/operating elements



- 1 Display
- 2 Status line
- 3 Menu line (top)
- 4 Menu line (bottom)
- 5 Indicator mains voltage 230V (utility power)
- 6 Timer display
- 7 Settings/values
- 8 Rotary/push-button
- 9 Back key

Menus in lines (3+4) can be selected with the rotary/push-button (8) and settings made. Output is via a display (1) with illuminated background. The back key (9) is used to jump back from a menu.

Fig. 95: Digital TRUMA control unit CP Plus

Rotary/push-button

The rotary/push-button (Fig. 95, Pos. 8) is used to select and change target values and then save them by tapping. Selected menu items flash.

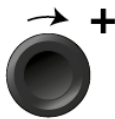

Rotate in a clockwise direction

Menu is run through from left to right.
Increasing of values (+)

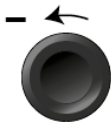

Rotate in an anticlockwise direction

Run through menu from right to left
Lowering of values (-).



Tapping

Apply (save) a selected value.
Selection of a menu item, change to the setting level.

Long press

Main ON/OFF switching function

If an iNet Box has been detected by a device search, then the function of the rotary/push-button changes (see "APP mode in conjunction with an iNet Box")

Fig. 96: Rotary/push-button

Back key



Fig. 97: Back key

If the back key is pressed, the display jumps back out of a menu and discards the settings. I.e., the existing values remain saved.

More information about configuration can be found in the operating manual provided by the manufacturer.

Functions

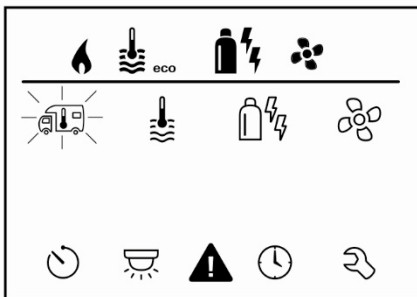

Fig. 98: Setting level display

The functions in the menu lines (Fig. 95, Pos. 3, 4) of the control unit Truma CP plus can be selected in any sequence. The operating parameters are displayed in the status line (Fig. 95, Pos. 2) or in the displays (Fig. 95, Pos. 5, 6).

Select setting level:

- Tap rotary/push-button.

The display shows the setting level. The first symbol flashes.

Switching on/off

Tap rotary/push-button.

NOTICE



Previously set values / operating parameters are once again active after switching on.

Switching off

Press the rotary/push-button for longer than 4 seconds.

NOTICE



After 2 seconds "APP"1 is output to the display. "OFF" is output after a further 2 seconds.

The switching off process of the Truma CP plus control panel can be delayed by a few minutes due to internal overruns of heating or air conditioning system.

1) Only in conjunction with an iNet Box.

Camping



Change room temperature

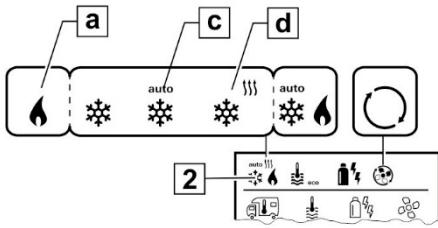

Fig. 99: Room temperature symbol

Select the symbol in menu line (3) using the rotary/push-button.

- Change to the setting level by tapping.
- Dependent on the connected device use the rotary/push-button to select between (HEAT)(d), air condition (AC) or automatic climate control¹⁾ (AUTO)(c).
- Tap rotary/push-button to confirm the selection.
- Select the desired temperature with the rotary/push-button.
- Tap rotary/push-button to confirm the value.

Heating (HEAT)

Adjustable temperature range 5 – 30 °C (1 °C steps)

a = heating) – heating is switched off.

- 1) Automatic air conditioning (AUTO) only if “ACC” has been activated in the service menu (see “Service menu”). This is switched off in the factory.
- 2) Symbol flashes until the desired room temperature is reached.



Changing the hot water level

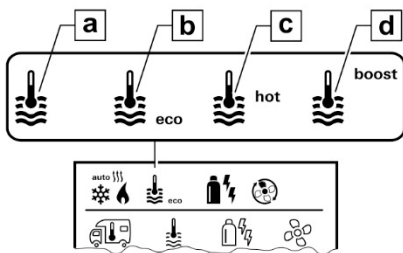

Fig. 100: Hot water level symbol

Select the symbol in menu line (3) using the rotary/push-button.

- Change to the setting level by tapping.
- Use the rotary/push-button to select the desired level.
- Tap rotary/push-button to confirm the value.

- = OFF
- a = Boiler
- b = eco
- c = hot
- d = boost

Water heating is switched off.

Water heating is switched on.

Hot water temperature 40 °C

Hot water temperature 60 °C

Targeted quick heating of the boiler content (boiler priority) for a maximum time window of 40 minutes. Then the water temperature is maintained at a higher level (about 62 °C) for two post-heating cycles, not Combi Diesel. Once the water temperature is reached, heating of the room continues.



Select energy mode

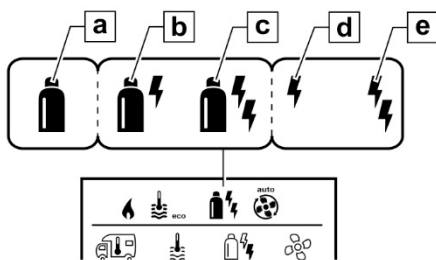

Select the symbol in menu line (3) using the rotary/push-button.

- Change to the setting level by tapping.
- Select the desired energy mode with the rotary/push-button.
- Tap rotary/push-button to confirm the value.

Fig. 101: Energy mode symbol

Symbol	Operating mode	Energy type
a	Gas / Diesel	Gas ¹⁾ / Diesel
b	MIX ²⁾	Electrical (900 W) + Gas / Diesel
c	MIX	Electrical (1800 W)
d	EL 1	Electrical (900 W)
e	EL 2	Electrical (1800 W)

1) Gas / diesel power, see instructions for use of the corresponding heater.

2) Mixed and electrical operation. Only possible for heaters with immersion heaters, e.g. Combi E CP plus ready.

Camping

Selecting the fan level

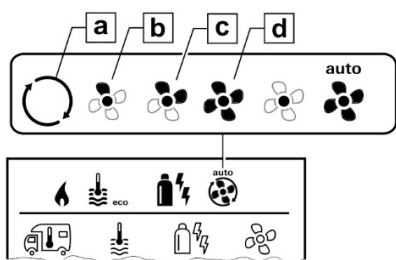

Fig. 102: Fan level symbol

Select the symbol in menu line (3) using the rotary/push-button.

- Change to the setting level by tapping.
- Select the desired fan level with the rotary/push-button.
- Tap rotary/push-button to confirm the value.

Symbol	Operating mode	Description
-	OFF	Fan is switched off. (can only be selected if no device is operating).
a	VENT ¹⁾	Recirculation air, if no device is operating and water heating is switched off. Speed selectable in 10 levels.
b	ECO	Low blower level.
c	HIGH ²⁾	High blower level
d	BOOST ³⁾	Quick room heating is available if the difference between the selected and actual room temperature >10 °C.

NOTICE



As soon as the heating is switched on (room temperature, hot water level set), the status line (2) indicates the fan level selected in the previous heating level. Pre-setting is "ECO".

- 1) Can result in higher motor wear, dependent on the frequency of use
- 2) Fan level "HIGH" is associated with higher power consumption, increased noise level and increased motor wear.
- 3) Not available with Combi Diesel



Setting the timer

WARNING



Risk of poisoning due to exhaust gases.

The activated timer switches the heating on even when the camper van is parked. The exhaust gas from the heating can result in poisoning in enclosed spaces (e.g. garages, workshops).

If the camper van is parked in an enclosed space:

- Shut off the fuel supply (gas or diesel) to the heating.
- Deactivate the timer of the Truma CP plus control unit (OFF).
- Switch off the heating at the Truma CP plus control unit.

NOTICE



During operation of air conditioning systems, only use the timer of the control unit Truma CP plus to clearly specify the start and end time of a desired time interval.

If the timer is activated (ON), the menu, the Deactivate timer (OFF) menu is first displayed.

- Select the symbol in menu line (4) using the rotary/push-button.
- Change to the adjustment level by tapping.

Camping

Enter the start time

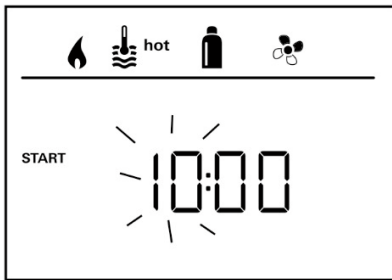

- Using the rotary/push-button, set the hours then the minutes.

Fig. 103: 24 h mode display

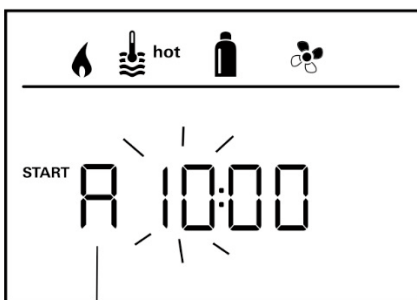

A = a. m.

P = p. m.

Fig. 104: 12 h mode display

Enter the end time

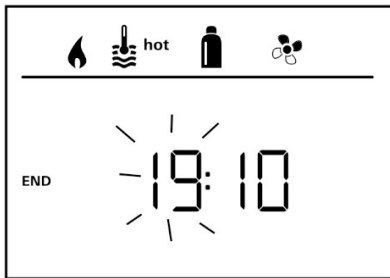

Fig. 105: 24 h mode display

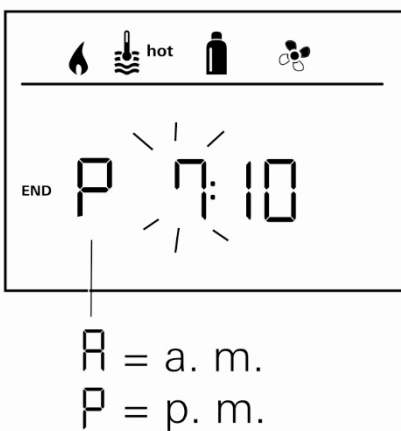

Fig. 106: 12 h mode display

Activating the timer (ON)

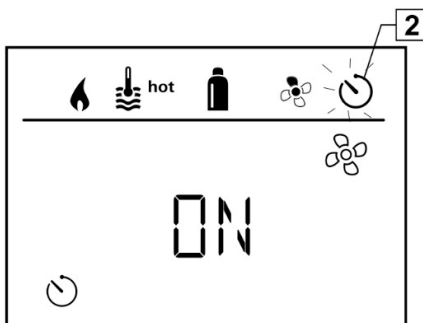

Fig. 107: Timer display

Using the rotary/push-button, set the hours then the minutes.

NOTICE



If the start/end time is exceeded upon entry, the operating parameters are only considered once the next start/end time is reached. Until then, the operating parameters set external to the timer remain valid.

- Use the rotary/push-button to activate the timer (ON)
- Tap rotary/push-button to confirm the value.

NOTICE



*The timer remains active, including over a number of days, until it is deactivated (OFF).
If the timer is programmed and active, the timer symbol flashes.*

Camping

Deactivating the timer (OFF)

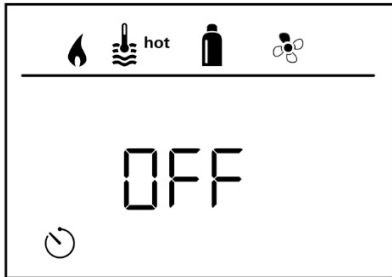

Fig. 108: Timer symbol

- Change to the setting level by tapping.
- Use the rotary/push-button to deactivate the timer (OFF)
- Tap rotary/push-button to confirm the value.



Switching the lighting on/off

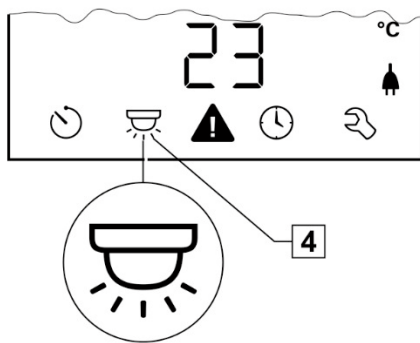

Fig. 109: Lighting symbol

Available if the air conditioning system is connected

Aventa comfort or Aventa eco

- Select the symbol in menu line (4) using the rotary/push-button.
- Change to the setting level by tapping.
- Select the desired function with the rotary/push-button.
 - Switch on 1 – 5 lighting.
 - Lighting selectable in 5 levels.
 - OFF - switch off lighting.
- Tap rotary/push-button to confirm the value.

Set time

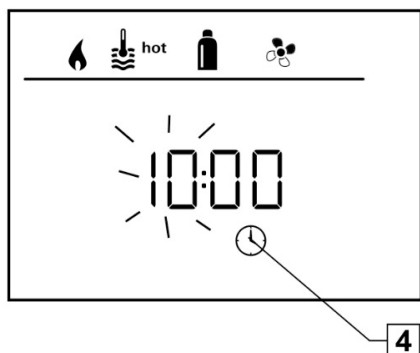

Fig. 110: 24 h mode display

- Select the symbol “Set time” in menu line (4) using the rotary/push-button (8).

The hour display flashes.

- Set the hours using the rotary/push-button (8).
- Press the rotary/push-button (8) again so that the minute display flashes.
- Set the minutes using the rotary/push-button (8).
- Tap the rotary/push-button (8) ■ to confirm the value.

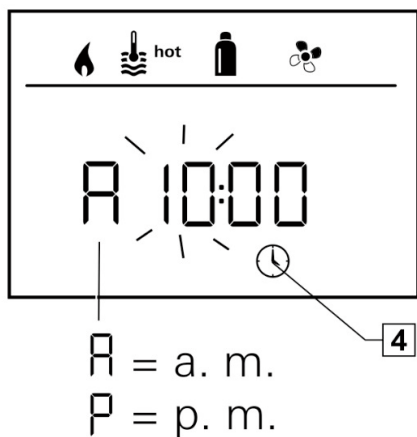

Fig. 111: 12 h mode display

Camping

 **Service menu**

Calibrating the heating room sensor (OFFSET)



Fig. 112: Presetting: 0 °C (Celsius)

The room temperature sensor of the connected heating can be adjusted individually at the sensor installation location. Setting is possible in steps of 0.5 °C in the range 0 °C to -5 °C.

Example:

Set room temperature 23 °C, OFFSET = -1 °C;

-Heating target value = 22 °C

Fault



Fig. 113: Fault

In the event of a fault the Truma CP plus control panel immediately jumps to the “Fault” menu level. The cause of the fault can be determined and rectified with the aid of the troubleshooting guides.

E = Fault

112 = Error code

H = Device

H = Heating

A = Air conditioning system

NOTICE



Contact a specialist workshop!

6.3.2 Heating the floor with hot water using the Truma Combi heater

In combination with the TRUMA Combi heater, the heating fluid is heated in a separate thermal unit.

Here, the hot air generated in the gas heater is channelled through the thermal unit. To accelerate the heating process, the 230 V heating element integrated in the thermal unit can be switched on.

Operation of the floor heater (optional)

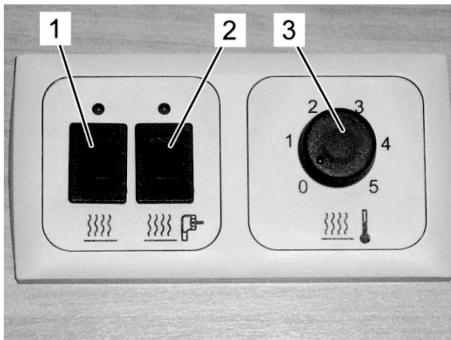

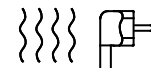
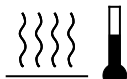

Fig. 114: Operating unit

The operating unit for the floor heater comprises the following switches and controls. The red LED light above the switches indicates that the operating mode is switched ON.

- 1  ON/OFF floor heater switch (turns the recirculation pump for the heater circuit on or off)
- 2  230 V electric heating element ON/OFF (not applicable if a ALDE heater is installed)
The 230 V heater element can only be switched on if the floor heater is also switched on.
- 3  Floor temperature control unit

6.3.3 Water heater

Mixer tap



Fig. 115: Mixer tap

WARNING



Danger of scalding due to hot water!

Hot water can scald hands and other body parts.

- Open the mixer tap in cold-water position and carefully raise the temperature.

1. To obtain water, turn the lever in direction of the cold-water setting (blue mark), lift upward, and slowly shift in direction of the red mark.
2. To close, turn the mixer lever in direction of the blue mark and push downward.

Camping

6.3.3.1 Applicable if the TRUMA combination heater is installed

1. Close the combined drain valve at the freshwater tank.
2. Close valves for cold and hot water pipes, see safety drain valve.
3. Fill fresh water tank.
4. Fill the boiler. Turn the mixer lever of the mixer tap in direction of the hot water setting (red mark) and pull upward. Cold water is pumped from the fresh water tank into the boiler.
5. Close the mixer lever after all air has been expelled from the water pipe and cold water flows.
6. Start the heater.

Hot water will be available after approximately 30 minutes.

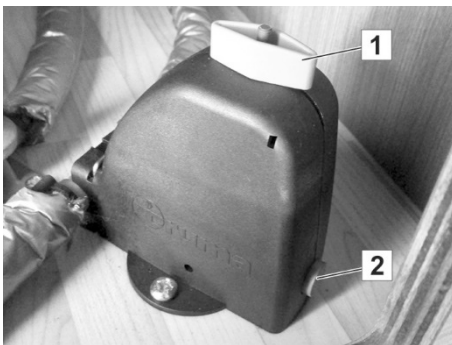

Fig. 116: Safety drain valve open

- Open drain valve manually:
To the top rotary switch (1) until it engages. A push-button (2), which is located at the bottom of the housing, will pop out (→ observe applicable operating instructions).
- Close safety drain valve:
When closing the valve, the push-button must be pressed and the rotary knob must be turned simultaneously 90 degrees. The push-button must remain in this position; otherwise, the valve will remain open.

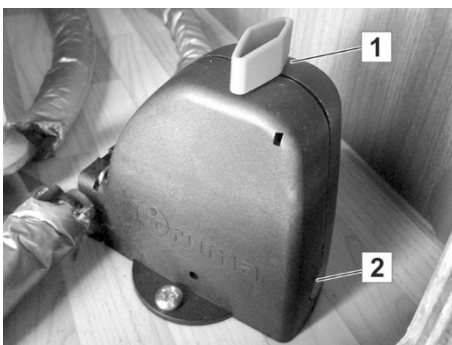
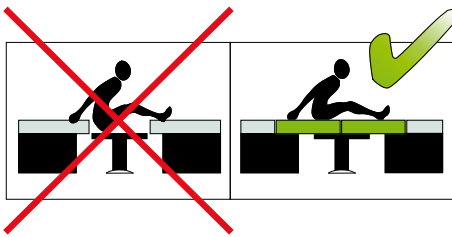

Fig. 117: Safety drain valve closed

6.4 Sitting and sleeping



CAUTION



Excessive load will damage the tabletop!

If the cushion is not in place, and the lowered tabletop is subjected to excessive load, the table may be damaged.

- Load may only be applied to the lowered tabletop (bed position) if the upholstery is in place.
- If the table is free-standing, the available accessories (strut, stool) must be added as support when the table is lowered.

6.4.1 Bistro table with table extension

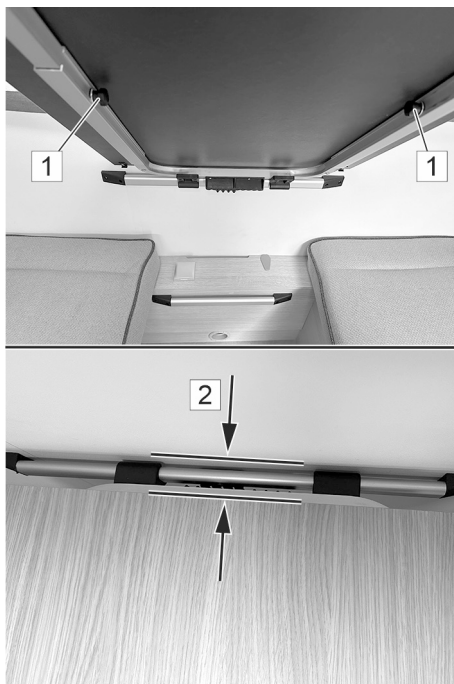

CAUTION



Damage due to incorrect handling!

If the bistro table is not fixed with the aid of adjusting screws, it may be damaged.

- Before lifting, always fix the bistro table with adjusting screws (1) underneath the tabletop at a distance (2) of approx. 30 mm from the side wall.

Camping



Fig. 118: Hook-in table

Depending on the model, the LMC Tourer Alkoven is equipped with a bistro table with the option of extending the table top.

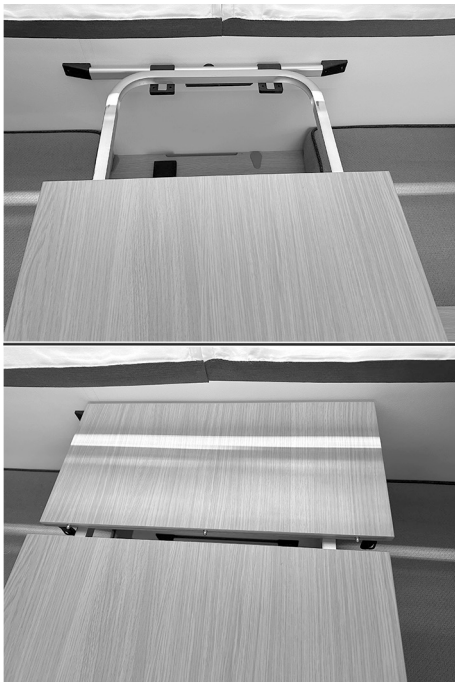

Fig. 119: Extending the bistro table

Extending the bistro table

1. Loosen the locking screws underneath the tabletop.
2. Pull out the tabletop.
3. Unfold the loose section towards the side wall.
4. Push the tabletop back together again.
5. Lock the retaining clips underneath the tabletop.
6. Tighten the locking screws underneath the tabletop.

6.4.2 Fold-out seat pan as bed extension



Fig. 120: Folded out bed extension

To enlarge the bed surface, the side panels of both bench seats can be extended (widened).

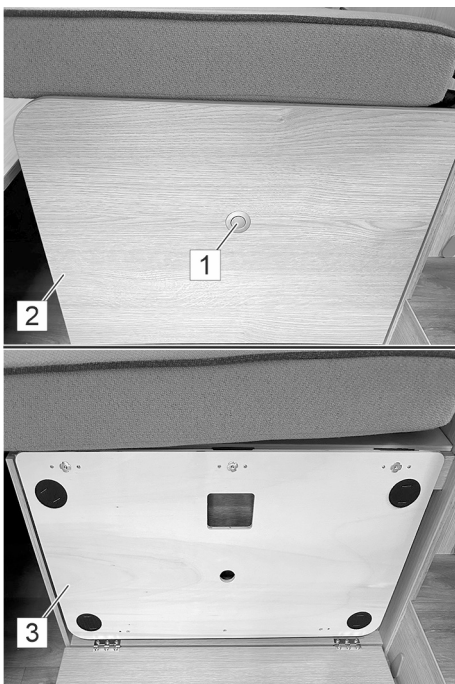

Fig. 121: Folding out the bed extension

Folding out the bed extension

1. Actuate the push-lock (1) and fold out the pan (2).
2. Raise the hinged upper section (3) and support it with the pan.

Camping

6.4.3 Converting the sitting area into berths



Fig. 122: Removing the bistro table

1. Lift the tabletop at the end and remove it from the upper wall bracket.
2. Press the button for unlocking the folding leg and fold the lower part over so that it engages.
3. Hook the tabletop into the bottom rail at this angle.
4. Carefully lower the tabletop until the support leg rests on the floor.

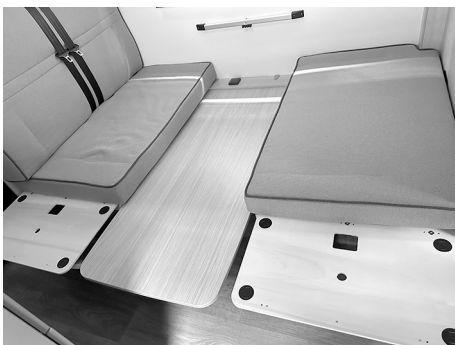

5. Extend the tabletop using the additional panel.
6. Extend the benches on the right and left.
7. Place the cushions on the lowered tabletop and the extended benches.



Fig. 123: Converted seating area

6.4.4 How to set up a berth



Fig. 124: Single beds

Depending on the selected features, there are foldable beds in the sleeping area and additional storage space underneath or two single beds.

- To turn this level into an end-to-end sleeping area, a sliding panel must be installed across the aisle between the single beds and additional cushions must be put in place.

Depending on the floor plan of the vehicle, instead of two single beds a double bed can be installed lengthwise or crosswise, or a bunk bed can be integrated.



Fig. 125: End-to-end sleeping area

Camping

6.4.5 Folding and unfolding the bed in the alcove

Safety instructions



Fig. 126: Alcove

WARNING



Danger of injury due to falling!

When sleeping, playing, or if they are in the alcove unattended, small children can fall through the passage and suffer broken limbs and permanent bodily injury.

Persons with limited mobility can fall when climbing up and climbing down or can injure themselves in the hinged pop-up roof.

- The alcove is not suited for unsupervised use by children under six years.
- Persons with limited mobility should avoid using the alcove.

CAUTION



Risk of injury if the ladder is used incorrectly!

If the ladder is used incorrectly, there is a risk of injury due to falling.

- When climbing up or down, always hold the ladder firmly.
- Never climb or descend the ladder with your back to the ladder.
- The ladder must not be stood on by more than one person at a time.
- Never exceed the maximum permitted load (100 kg).

CAUTION



Risk of injury when exiting!

Jumping from the alcove may cause injuries due to breaking objects.

- Never jump from the alcove to the floor or climb down without checking where you step.
- Do not step on furniture or the covers of the hob or sink.
- Always use the access ladder to exit the pop-up roof.

Care tips

NOTE



Prior to longer periods between use, remove the bed pad from the alcove to avoid stagnant moisture and mildew.

6.4.6 Setting up the lighting

DANGER



Life-threatening danger due to electric shock!

Danger of electric shock potentially resulting in serious or fatal injury when working on electrical equipment.

- Any repair tasks on the electrical system must be performed by qualified personnel.
- Replace defective fuses only after the cause of the fault has been identified and rectified.

CAUTION



Risk of fire due to the use of incorrect light bulbs!

The use of incorrect light bulbs, in particular in the sleeping and bed areas, can generate excessive heat and cause a fire.

- Only use approved light bulbs.
- Only LED light bulbs are permitted in the bed area.

Depending on the selected model and equipment, the living and sleeping areas are fitted with various types and different number of lamps, e.g., ceiling lights, spotlights, light strips and corner lights.

Changing light bulbs is simple. Depending on the model:

1. Carefully open and remove the housing.
 2. Remove the broken bulb from its socket.
 3. Install the new bulb.
 4. Carefully place and close the housing.
- If there are defects in the lighting fixtures that you cannot correct yourself, visit a customer service facility!

Camping

Adjusting the brightness (optional)



Fig. 127: Multifunction switch (example)

In some vehicle models, individual lights, light strips or panelling with the light effects are installed in various locations inside the motorhome. Depending on the vehicle model, the brightness of the lights can be adjusted by simply pressing a button or activating a dimmer switch:

- Dimmer switches: Adjust the dimmer switch to the desired level of brightness.
- When using a multi-function light: Press and hold the button until the desired brightness is set.
- To simply switch the lights on/off without regulating brightness, briefly press the respective light button once.

6.5 Bathroom

6.5.1 How to use the shower

The shower is enclosed by a curtain that must be fixed in its open position while travelling. When taking a shower, release the locking mechanism and close the shower curtain.

A hot water boiler is used to supply the shower with warm water. To drain the shower water, activate the single lever mixer tap.

6.5.2 How to use the wash basin



Fig. 128: Washbasin

There is also a washbasin located in the bathroom. It is fed from the hot water boiler. To drain the water, activate the single lever mixer tap.

6.5.3 Flushing the toilet with revolving toilets (optional)

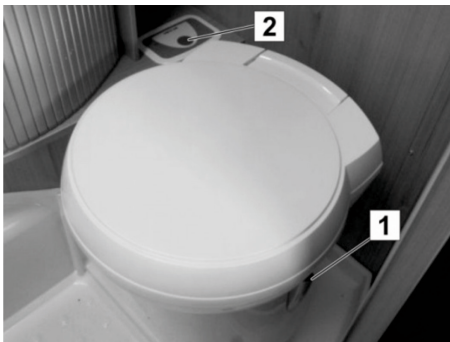

Fig. 129: Pivoting toilet

1. Manually rotate the toilet seat in closed state into the desired position.
2. To flush, turn the lever (1) at the toilet bowl side counter-clockwise.
3. Push the flushing button (2). The operating panel is activated.
4. Push again the flushing button (2).
5. After flushing, turn the lever (1) clockwise.

6.5.4 Emptying the waste holding tank

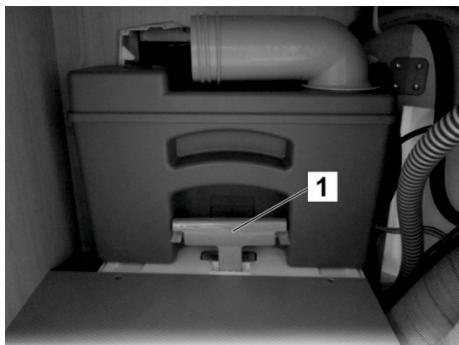

Fig. 130: Waste holding tank in the disposal shaft

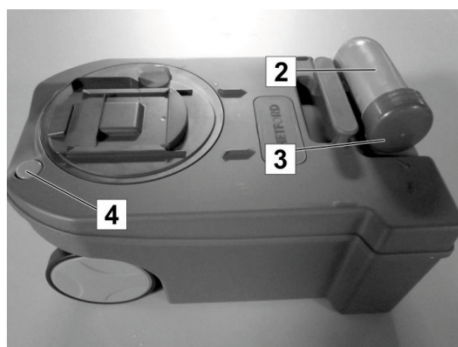

Fig. 131: Emptying the waste holding tank

NOTICE



The waste holding tank must be emptied at the latest when the fill level indicator next to the flushing button is illuminated.

Completely empty the holding tank if there is danger of freezing and the caravan superstructure is not heated.

NOTICE



Faeces and chemicals harm the environment.

- *Drain the waste holding tank only at the designated disposal points.*

1. Close the slide gate at the toilet bowl.
2. Open the sanitary compartment at the outside of the caravan body.
3. Use the handle (1) to remove the waste tank from the disposal shaft.
4. At a designated disposal station, swivel the discharge pipe (2) to the side and unscrew the cap (3).
5. Press and hold the coloured button (4) of the venting valve and empty the waste holding tank.
6. Use fresh water to clean the tank, replace the cap on the discharge pipe and return the pipe to its position.
7. Push the waste holding tank into the disposal shaft until the bracket latches.
8. Lock the sanitary compartment.
9. Refill with new sanitary fluid.

6.6 Kitchen area

6.6.1 Using the combination hob including fitted sink

WARNING



Burn injuries due to open gas flame!

Very high temperatures are present in the area around the gas flame, especially above it. Reaching into the area will result in burns.

- Always maintain a safe distance from the gas flame.

WARNING



Risk of explosion and poisoning due to gas!

Escaping gas can cause explosions and poisoning.

- Never let gas escape without igniting.
- If there is an unexpected smell of gas:
 - Immediately shut down the gas supply.
 - Do not operate any electric devices.
 - Remove fire and sources of ignitions.
 - Do not smoke.
 - Ventilate thoroughly.
 - Have gas system repaired immediately.
- All repairs on the gas system must only be performed by authorised specialist personnel.

Before using the hob, all combustible materials such as curtains, towels and clothes must be removed from the danger area. When cooking, additional ventilation must be provided, e.g., by opening any windows in the vicinity of the grill, hob and oven. Do not use the hob and oven for heating purposes.

Camping

Minimum and maximum pot sizes

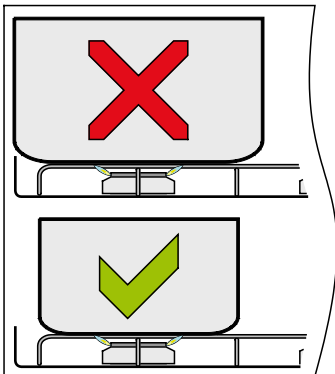

Fig. 132: Pot sizes

CAUTION



Risk of fire due to oversized pots!

Using oversized pots can cause overheating and thus a heightened risk of fire.

- Place the pots and pans centred above the burner.
- Used pots and pans must not be larger than the pan stand on top of the burner.
- The operating manual of the device manufacturer provides information about the permissible pot sizes.

NOTE



- *This device must be only operated with liquefied gas.*
- *Use only the specified gas pressure.*
- *This device is approved solely for the use with propane or butane gas.*
- *We recommend to use propane with this device.*
- *Using butane may lower the device output if the ambient temperature is less than 10 °C.*
- *Do not use butane if the ambient temperature drops below 5 °C.*
- *This device must be earthed.*

Cooking



Fig. 133: Combination cooking hob (example)

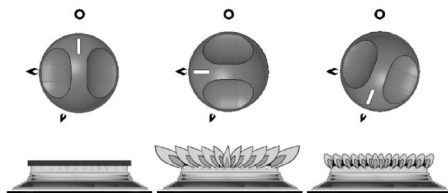

Fig. 134: Settings of the operating elements:
OFF, High flame, Low flame

The gas cooker is located underneath a safety glass plate.

1. Lift the glass plate. The separate glass plate of the sink can remain closed.
2. Open the gas bottle valve and "cooker" quick-action valve.
3. Press the switch button and turn it anticlockwise to the highest position (high flame)
4. Press the button further and hold a burning match or barbecue lighter against the burner. In models with automatic ignition, the procedure is similar, except for the automatic ignition when the button is pressed. In models with manual ignition, the procedure is similar, except that you must press the ignition button on the front plate to ignite the burner.
5. After ignition, keep the button pressed for another 10 to 15 seconds.
6. Release the button and use the regulator to adjust the gas flame to the required level. Do not push the regulator when adjusting.
7. If the burner does not ignite within 15 seconds, release the button and wait for at least one minute before you repeat steps (3) to (6).
8. To switch off, turn the button until the line on the button is aligned with the spot on the control panel.

NOTE



After the flame extinguishes, the safety pilot valve automatically blocks the gas supply.

The gas supply is also automatically shut off when the glass lid is folded down.

9. Close the "cooker" quick-action valve and the gas bottle valve.
10. Wait until the cooker has cooled down, clean, and cover with the glass plate.

Camping

6.6.2 Using the oven with grill function (optional)

The baking oven with grill (optional) is installed on special request.

WARNING



Risk of burns due to hot oven!

A hot oven can cause burn injuries.

- Never touch hot surfaces. Keep children away.
- Always open the door when igniting the oven.
- When grilling, remove the heat protection shield and keep the door slightly ajar.

Baking



Fig. 135: Oven with grill

1. Open the gas bottle valve and the "Oven" quick-action valve.
2. Open the oven door.
3. Turn the operating knob to 240°, push and keep pushed.
4. Quickly press the ignition button with the lightning symbol several times, until the flame ignites in the oven space.
5. Keep the operating knob depressed for an additional 10-15 seconds, then release it. If the burner does not ignite, wait for at least 1 minute before the next ignition attempt.
6. Slide in the oven rack and close the oven door.
7. Turn the operating knob to 180° and preheat the oven for approx. 10 minutes (full heat will be obtained after 15-20 minutes).
8. Place the food to be baked in the oven, close the oven door, and select the baking temperature on the operating knob.
9. After baking, turn the operating knob to "o".
10. Use pot holders or oven gloves to remove the baked goods out of the oven; let the oven cool down.

Grilling

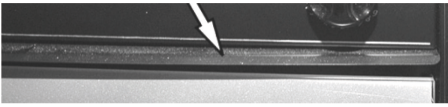

Fig. 136: Heat protection shield

1. Open the gas bottle valve and the "Oven" quick-action valve.
2. Open the oven door and pull the heat protection shield from below the operating panel.
3. Press and turn the operating knob with the symbol for "top heat" (= grill operation) and keep pressed.
4. Quickly press the ignition button with the lightning symbol several times, until the flame ignites in the oven space.
5. Keep the operating knob depressed for an additional 10-15 s, then release it. If the burner does not ignite, wait for at least one minute before the next ignition attempt.
6. Place the food in the oven, fold up the door and leave slightly ajar.
7. Select the required temperature at the operating knob.
8. After grilling, turn the operating knob back to the "0" position.
9. Use pot holders or oven gloves to take the grilled food from of the oven, and let the oven cool down.

Camping

6.6.3 12 V compressor refrigerator (option)

NOTE



Prior to first use and cleaning, and when parking for longer periods (e.g. winter break) read the accompanying operating manual provided by the manufacturer of the refrigerator!

Overview

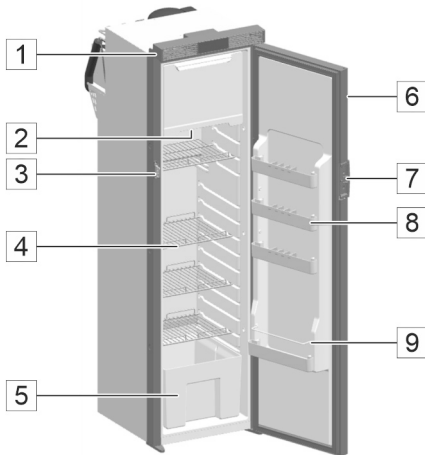

Fig. 137: 12 V compressor refrigerator

- 1 Ventilation opening
- 2 Built-in light
- 3 Locking pawl
- 4 Refrigerator shelf
- 5 Fruit and vegetable container
- 6 Door
- 7 Handle
- 8 Door compartment
- 9 Bottle rack

The refrigerator requires a 12 V direct current supply.

- To conserve battery power, the refrigerator shuts off automatically if the voltage is too low.
- The winter covers must be removed before start up
- The refrigerator should not be filled until four hours after first switching it on.
- The permissible weights for the open trays and compartments are:
 - 5 kg per shelf
 - 2 kg per door compartment
 - 4 kg for the door as a whole
- The cooling performance and power consumption are affected by:
 - Ambient temperature
 - Ventilation
 - The amount of contents in the refrigerator

Controls

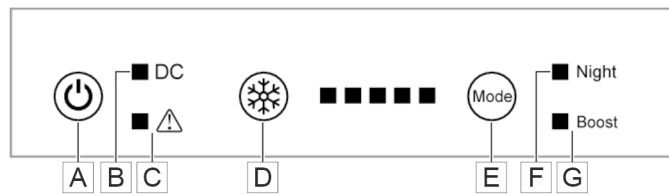

Fig. 138: 12 V compressor fridge controls

- | | | | |
|---|----------------------------------|---|---------------------------------|
| A | On/Off switch | E | Operating mode selection button |
| B | 12 V DC | F | Night mode |
| C | Fault indicator lamp | G | Boost mode |
| D | Temperature adjustment indicator | | |

- The cooling temperature is regulated by pressing the temperature setting button once or more.
- In night mode, the refrigerator runs at low speed; in boost mode, the compressor runs at a high speed, which can be set via the mode button.

NOTE



If the refrigerator is not going to be used for a long time, observe the following:

- Switch off the refrigerator and disconnect it from the power supply.
- Latch the refrigerator doors in their ventilation state.

Camping

6.6.4 Refrigerator for 12 V operation (option)

NOTE



Prior to first use and cleaning, and when parking for longer periods (e.g. winter break) read the accompanying operating manual provided by the manufacturer of the refrigerator!

Overview

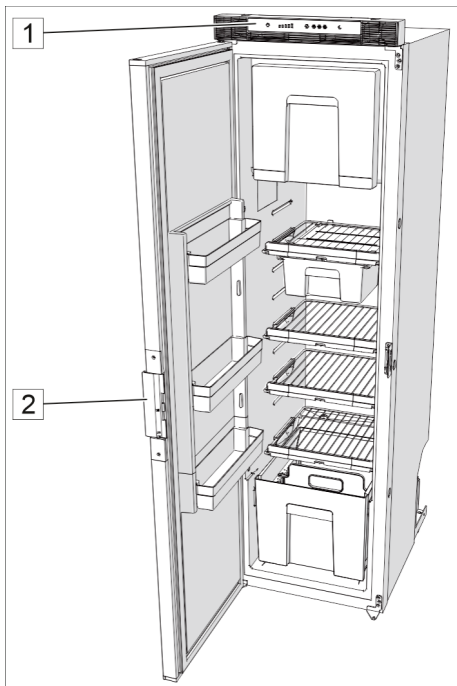

Fig. 139: 12 V Thetford refrigerator

The refrigerator is operated with a supply voltage of 12 V DC.

- When driving, the refrigerator is supplied with 12 V from the vehicle's alternator.
- Always ensure an external 230 V power supply is available during parked operation so that the supply battery is not discharged.
- Dependent on the charging state of the supply battery, the refrigerator can also be operated for a limited period without an external 230 V power supply.
- To open, pull the door lock (2) on the side of the refrigerator and swing the door open.

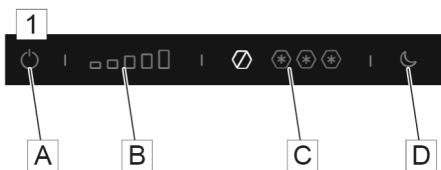

Fig. 140: LED operating panel

Operating panel (1)

- A On/off button
- B Temperature settings - storage compartment for fresh food
- C Temperature settings - freezer compartment
- D Night mode button

Switching the refrigerator on

1. Press and hold the ON/OFF button (A) for one second. The operating panel comes on.
2. After a few seconds, the operating panel switches to standby and locks. Moreover, the blue ON/OFF button indicates that the refrigerator is operating.

Selecting the cooling level

1. Unlock the operating panel by pressing and holding the desired temperature setting range (B)(C) for a few seconds. The activated range starts to flash.
2. Push or press the temperature icons to select the desired refrigeration level.
3. After a few seconds, the operating panel saves the setting and switches to the locked standby mode.

Activating night mode

1. Unlock the operating panel by pressing and holding the night mode button (D) for a few seconds. The activated range starts to flash.
2. Push or press the temperature icons to select the desired refrigeration level.
3. After a few seconds, the operating panel saves the setting and switches to the locked standby mode.

NOTE



Only use night mode when temperatures in the vehicle are less than 30 °C. Night mode switches off automatically after 12 hours. If night mode is switched off manually, operation automatically switches to automatic temperature control.

On the road

Close the refrigerator and push against the refrigerator door to automatically lock the door. The door lock (2) also secures the door during the drive.

NOTE



Ensure that all objects in your refrigerator are well secured against shifting. Secure bottles in the door with the bottle holder and ensure that foodstuff in the shelves is held in place.

Deactivating the refrigerator

- Press and hold the ON/OFF button (A) for one second. All lamps on the operating panel go out.

7 Maintenance

Proper care requires the right cleaner for the various materials. This applies to both the exterior and interior of the vehicle. To maintain an overview of the variety of materials used, we have compiled a list of the materials, their properties and the requirements for the appropriate cleaner in a table in the appendix.

CAUTION



Damage due to use of the incorrect cleaner!

Use of incorrect cleaning agents may result in damage to the surface being cleaned.

- Always observe the manufacturer's instructions for diluting the cleaner.
 - Before using the cleaner, compare the pH value with the information in our table.
-

7.1 Exterior cleaning

NOTE



Acrylic glass window panes are very sensitive and require special care.

Only clean wet with a clean sponge or soft cloth.

Avoid using chemical cleaning agents, glass cleaner and other aggressive cleaners.

Use special acrylic glass cleaner for stubborn stains.

1. Prior to cleaning the vehicle, close all doors, windows, and skylights.
2. Apply a weak water jet to the entire caravan at an approved vehicle washing facility.
3. Wash the vehicle with a soft sponge and mild shampoo solution and rinse with water.
4. Dry the caravan (e.g. with a chamois); remove, in particular, moisture on lamp holders, window frames, etc.
5. Treat the surfaces with a suitable preserving agent.

NOTE



Because GFRP surfaces age faster than coated surfaces, they may become dull and attract moss and algae growth. For this reason, GFRP surfaces must be polished and sealed with wax at least once year to be protected against UV light and ageing. Suitable polishes and sealants are available from specialist distributors for camping and water sports products.

6. Plastic parts such as bumpers and skirting panels should be cleaned with off-the-shelf, non-aggressive plastic cleaning agents.
7. Apply a rubber care agent (talcum for example) to rubber door and window elements.
8. Grease door hinges, stabilisers and joints as needed.

Maintenance

7.2 Interior cleaning

1. Use standard, non-corrosive and non-abrasive household cleaning and care products for the interior and floor.
2. Wipe off furniture surfaces with a damp cloth, use furniture polish if necessary.
3. Vacuum off the upholstery or clean it carefully with a mild foam cleaner. Do not wash.
4. Use the provided care set (optional) to clean all items covered with leather. When doing so, follow the attached care instructions.

NOTE

For additional information about how to care for your leather upholstery, see www.lederpflege.de.

-
5. Thoroughly rinse and disinfect the fresh water tank and fresh water lines, empty and clean the waste water tank.
 6. Use designated non-abrasive steel cleaners to clean the sink and hob to avoid scratching.
 7. Use designated plastic cleaning and care products to clean plastic parts such as shower and washbasin.
 8. No corrosive or abrasive cleaning agents containing solvents or alcoholic substances should be used to clean 3D thick edges in the furnished area.

7.3 Preparing the caravan for periods of non-use

- Take the following measures.
- Supplemental tasks for winter care are indicated by the letter **W**.
- Amend this list to meet your specific requirements.

Component	Activity		✓
Basic vehicle			
	Thoroughly clean the vehicle and the underbody, repair rust and paint damage.		
	Fill the fuel tank.		
	Check the starter battery, fill, recharge if necessary.		
	Remove the starter battery and store it in a frost-free location.	W	
	Check the non-freezing liquid for the engine cooling water and windscreen washer system, replenish if necessary.	W	
	Check the air in the tyres, inflate to specified pressure.		
	If possible, jack up the vehicle; otherwise move the vehicle every 4 weeks to prevent pressure marks on tyres and wheel bearings.		
Motorhome body			
Exterior	Ensure to remove all grime, branches, leaves, snow and ice from the vehicle; this applies in particular to the roof of the vehicle.		
	Thoroughly clean the motorhome body, repair rust and paint damage.		
	Clean and lubricate the hinges on doors and hatches.	W	
	Treat locks with graphite dust.	W	
	Rub talcum into the sealing rubber.	W	
Interior	If possible, remove the upholstery from the motorhome and store it in a dry location; if this is not possible, put it in a vertical position for better ventilation.	W	
	Remove clothing, objects of daily use, cosmetics, canned goods and perishable goods from closets, storage areas and compartments.		
	Clean all closets, storage areas, and compartments with a damp cloth.		
	remove all food and beverages from the refrigerator, leave an air gap when closing the refrigerator door.		
	Set up air de-humidifiers.	W	
	Repeatedly and thoroughly ventilate the interior.	W	

Maintenance

Component	Activity		✓
Electrical system	Check the supply battery, fill, recharge if necessary.		
	Remove the supply battery and store it in a frost-free location.	W	
Water system	Empty the fresh water tank, open the tank locking mechanism.		
	Drain the hot and cold water system, open all water cocks to middle position and leave them open.		
	Blow out any water remaining in the water lines with compressed air (oil-free, max. 0.5 bar).		
	Empty the siphons in the kitchen and bathroom area.	W	
	Empty and clean the waste water tank.		
	Flush the toilet.		
	Empty and clean the sewage (black water) tank.		
	Let the water pump run dry for approx. 1 minute.	W	
Heater	Remove water from the boiler. To do this, open the drain valve and the safety drain valve.		
Gas system	Close the gas bottle valves and remove the gas bottles from the gas locker.		
	Close the quick-action valves.		

8 Maintenance and inspection

General

Maintenance includes inspection, servicing and repair.

Service tasks described in the sections below are required for optimal and trouble-free vehicle operation.

- In the event that increased wear is detected for specific components in the context of regular inspections, shorten the required service intervals based on the actual wear indications!

In addition to this operating manual, the operating manuals supplied for the built-in devices also apply. The instructions contained therein - particularly the safety instructions cited in these manuals - must be complied with!

If you have questions concerning service work and intervals: Contact the manufacturer (service address → page 2).

WARNING



Danger of accident and injury due to improper maintenance!

Improper maintenance or repair can cause serious accidents or injuries.

- Have repairs to the vehicle or chassis, electrical system, gas system and gas consumers performed only by authorised specialists.

Maintenance and inspection

8.1 Maintenance schedule

Interval	Component	Action required	✓
Weekly	Supply battery	Check charge status	
Monthly	Main switch (FI)	Function check	
	Tyres	Check the tyres: Condition, tread depth, fill pressure	
	Fresh water tank and fresh water system	Clean and disinfect	
	Waste (grey) water tank, sewage (black water) tank	Empty and clean	
semi-annually	Doors, service hatches, storage compartments	Clean and grease joints and hinges	
	Hinged windows, sliding windows, skylights	Leak test Clean and grease joints and hinges	
	Power-operated entrance step	Clean and grease joints	
	Auxiliary supports	Clean and grease joints and threaded rods	
annually	Electrical system	Function check	
	Fresh water and waste water system	Function check, leak test	
	Heater, boiler, gas cooker	Function check	
	Refrigerator lighting	Function check	
	Seals on the doors, storage and service hatches, windows, skylights, and safety straps	Function check	
	Sealing strips, sealing edges, sealing rubber	Check for damage	
	Gas burner, refrigerator	Have them cleaned by an authorised workshop	
	Under-body protection	Check	
every 5 years	Renew the ALDE heater glycol-water mixture	Have it replaced by an authorised workshop	
every 6 years	Gas pressure regulator	Have it replaced by an authorised workshop	
every 10 years	Smoke detector	Replace	

8.2 Inspection schedule

Interval	Component	Action required	✓
Every 12 months	Caravan body	Leak test: Annual inspections provided by an authorized dealer (5 year warranty against leaks)	
Every 2 years	Overall vehicle	Main motor vehicle inspection* according to the Road Traffic Act and the Road Traffic Registration Act (e.g., TÜV, DEKRA)	
	Vehicle exhaust system	Inspection of the vehicle exhaust system*	
	Entire fuel supply system	Official inspection by an authorised specialised company	

*

NOTICE



All vehicles exceeding a total weight of 3.5 t are subject to an annual inspection.

8.3 Changing wheels

The instructions on how to change a tyre depends on the vehicle model. Detailed instructions can be found in the operating manual provided by the manufacturer of the base vehicle.

WARNING



Risk of injury and accident while changing a tyre!

Lack of practice, insufficient knowledge of the vehicle and how to change a tyre can lead to injuries.

If a tyre is installed improperly, severe accidents may be the result.

- Always follow the operating instructions of the base vehicle.
- If inexperienced and lacking practice, contact a roadside assistance service provider.
- For immediate help, use a tyre repair set available from your specialized dealer. Compliance with the instruction manual is mandatory.

Malffunctions

9 Malffunctions

General

This chapter provides information about troubleshooting. Malffunctions for which causes and remedies are not explained here must be corrected by an authorised workshop.

If the basic vehicle is malfunctioning, refer to the operating manual of the manufacturer or contact the vehicle customer service provider.

Additional information concerning malffunctions is also provided in the operating manuals for the built-in devices. If the malffunction correction measures described in those manuals are not successful, then contact an authorised workshop.

WARNING



Danger of accident and injury due to improper troubleshooting!

Improper troubleshooting can cause serious accidents and injuries.

- Only an authorised and specialised technician shall be permitted to proceed with repairs to the electrical system, the gas system, and gas consumers.

9.1 Caravan body

Malffunction	Cause	Remedy
Exterior:		
Hinges on the outside door, storage and service hatches do not move easily	Insufficient hinge lubrication	Lubricate hinges with acid-free and resin-free grease
The joints of the entrance step and the bicycle lift are sluggish	Insufficient hinge lubrication	Lubricate hinges with acid-free and resin-free grease
Interior:		
Hinges and joints in the bathroom, the flaps and doors do not move easily	Insufficient hinge/joint lubrication	Lubricate hinges and joints with acid-free and resin-free grease

9.2 Electrical system

DANGER



Life-threatening danger due to electric shock!

Touching live components can cause serious or fatal injury.

- Prior to any work, switch off the electrical system and disconnect from the mains supply.
- Switch off the ELCB.

Fault	Cause	Remedy
In spite of being connected to the power supply the 230 V mains power is not working	Power cable is not connected	Connect the power cable
	The 230 V circuit breaker in the motorhome has tripped	Determine the defect and eliminate it; if necessary, consult a specialist workshop. Subsequently, switch on the circuit breaker.
	The 230 V fuse at the camp site has tripped	Have the fuse at the camp site checked and switched on by the groundsman
When connected to a 230 V outlet, the starter and supply battery batteries do not charge	Charging module in the Elektroblock defective	Contact a specialist workshop
	The 40 A blade-type fuse of the starter or supply battery is defective	Determine the defect and eliminate it; if necessary, consult a specialist workshop. Then replace 40 A blade-type fuse of the starter or supply battery.
12 V power supply does not work during the 230-V operation	12 V main switch of the supply battery is turned off	Turn on the 12 V main switch
	The 230 V circuit breaker in the Elektroblock has tripped	Have the electrical system checked by a specialised workshop
	The disconnect switch of the supply battery is turned off on the Elektroblock	Switch on the supply battery disconnect switch
	The 40 A blade-type fuse of the supply battery is defective	Determine the defect and eliminate it; if necessary, consult a specialist workshop. Then replace the 40 A blade-type fuse of the supply battery.

Malfuctions

Fault	Cause	Remedy
12 V power supply does not work during the 230-V operation	Charging module in the Elektroblok defective	Contact a specialist workshop
	The supply battery is deeply discharged	Use an external charger to charge the supply battery
The 12 V supply does not work during 12 V supply battery operation	12 V main switch of the supply battery is turned off	Turn on the 12 V main switch
	The supply battery is deeply discharged	Use an external charger to charge the supply battery
	The 40 A blade-type fuse of the supply battery is defective	Determine the defect and eliminate it; if necessary, consult a specialist workshop. Then replace the 40 A blade-type fuse of the supply battery.
	The disconnect switch of the supply battery is turned off on the Elektroblok	Switch on the supply battery disconnect switch
	Cut-off relay in the Elektroblok is defective	Contact a specialist workshop
The 12 V indicator light is not illuminated	The 12 V main switch is turned off	Turn on the 12 V main switch
	Starter or supply battery discharged	Charge the starter or supply battery
	The disconnect switch of the supply battery is turned off on the Elektroblok	Switch on the supply battery disconnect switch
	Cut-off relay in the Elektroblok is defective	Contact a specialist workshop
	The 2 A blade-type fuse of the supply battery is defective	Determine the defect and eliminate it; if necessary, consult a specialist workshop. Then replace the 2 A blade-type fuse of the supply battery
The starter battery discharges during 12 V operation	Cut-off relay in the Elektroblok is defective	Contact a specialist workshop

Fault	Cause	Remedy
Supply battery does not charge during driving	The supply battery is deeply discharged	Use an external charger to charge the supply battery
No voltage at supply battery	The supply battery is deeply discharged	Use an external charging unit to charge the supply battery
	<p>CAUTION</p> <p> Material damage due to deep discharge! If deep discharging occurs, the supply battery is destroyed.</p> <ul style="list-style-type: none"> Compliance with the supply battery's care and maintenance instructions is mandatory. 	
Lighting system does not function or does not function completely	Bulb is defective	Replace the bulb, observe voltage and amperage
	Fuse in the Elektroblok defective	Determine the defect and eliminate it; if necessary, consult a specialist workshop. Subsequently, replace the fuse in the Elektroblok.
Electrical entrance step cannot be extracted or retracted	Entrance step is jammed	Loosen the entrance step, grease hinge
	Fuse in the Elektroblok defective	Determine the defect and eliminate it; if necessary, consult a specialist workshop. Subsequently, replace the fuse in the Elektroblok.
	Contact switch defective	Contact a specialist workshop
Electric lift-up bed does not work	20 A plug-in fuse defective	Replace the plug-in fuse

Malfunions

9.2.1 Alarms Operating and control panel LT 460 A

Alarm	Cause	Remedy
12 V supply not working (or partial areas are not supplied)	12 V mains switch is switched off	Switch 12 V main switch on
	Fuse defective	Replace fuse
	Corresponding EBL is overheated	Let the unit cool down
12 V indicator LED (green) does not come on	12 V mains switch is switched off	Switch 12 V main switch on
	Living space battery not charged	Charge the living space battery
	Fuse defective	Replace fuse
No voltage from the living space battery 12 V supply not working (or partial areas are not supplied)	Living space battery is discharged	Charge the living space battery immediately If the living space battery remains in a deeply discharged state for a long time, it will be irreparably damaged
	12 V mains switch is switched off	Switch 12 V main switch on
12 V indicator LED (green) does not come on	Fuse defective	Replace fuse
	Corresponding EBL is overheated	Let the unit cool down
	12 V mains switch is switched off	Switch 12 V main switch on

9.2.2 Changing light bulbs

DANGER

**Life-threatening danger due to electric shock!**

Danger of electric shock potentially resulting in serious or fatal injury when working on electrical equipment.

- Any repair tasks on the electrical system must be performed by qualified personnel.
- Replace defective fuses only after the cause of the fault has been identified and rectified.

CAUTION

**Risk of fire due to the use of incorrect light bulbs!**

The use of incorrect light bulbs, in particular in the sleeping and bed areas, can generate excessive heat and cause a fire.

- Only use approved light bulbs.
 - Only LED light bulbs are permitted in the bed area.
-

Malfunctions

Changing the (optional) light above the bed



Fig. 141: Remove the cover

1. Use a screwdriver to carefully remove the light cover.
2. Remove the light bulb.

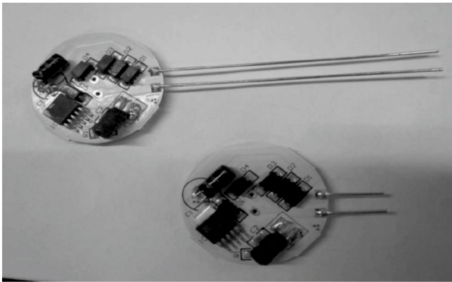

Fig. 142: Shortening the contacts

3. Shorten the contact of the LED light to 10 or 15 mm.

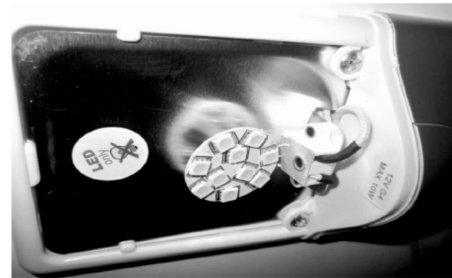

Fig. 143: Inserting the LED light

4. Inserting the LED light.



Fig. 144: Mounting the light cover

5. Install the light cover in the same position as it was before.

Replacing the LED

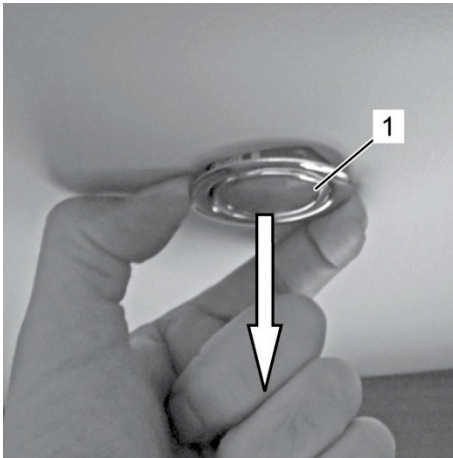

Fig. 145: Pull out the LED

1. Carefully pull the LED (1) and the wire from the recess.
2. Pull the plug from the socket, this will disconnect the LED from the cable.

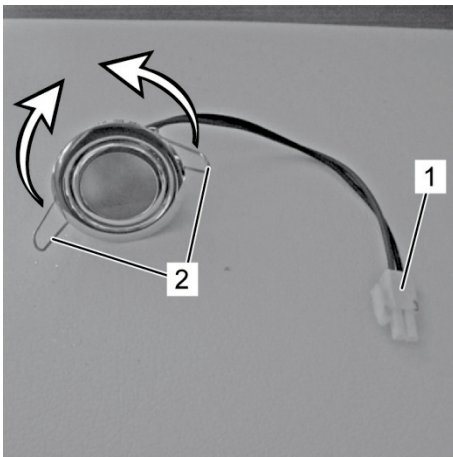

Fig. 146: LED general arrangement

3. Insert the plug (1) into the socket.
4. Push the retainer brackets (2) of the new LED up (arrows) and keep them depressed.
5. Insert the LED into the recess.
⇒ The retainer brackets snap into place and the new LED is placed firmly into the recess.

Malfuctions

Defective vehicle lights

The design of modern vehicle lighting systems are rather complex. They are effectively protected against permeating moisture and adjusted for today's traffic requirements.

Still, replacing vehicle lights require special knowledge and skills, since improper replacement of the bulbs can change previous settings.

WARNING



Risk of accident

Changing the settings of the vehicle's lights can lead to severe accidents.

- If necessary, have a specialised workshop change the light bulbs.

Further information can be found in the enclosed manufacturer's operating instructions for the base vehicle.

Replacing the bulb of the rear lamp unit

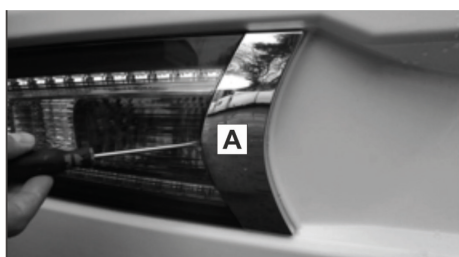

Fig. 147: Rear lamp assembly

6. Pull the chrome strip (A) off from the rear lamp assembly towards the rear.

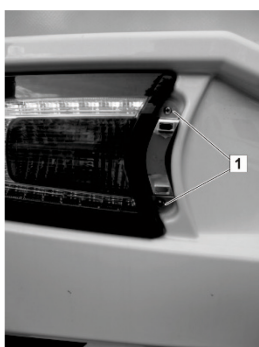

Fig. 148: Remove the rear lamp assembly

7. Use a screwdriver to remove the screws (1) of the rear lamp assembly.
8. Carefully swivel the rear lamp assembly.

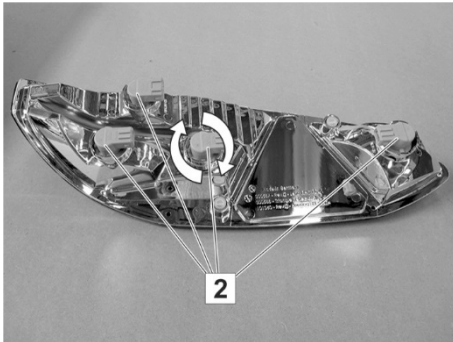

Fig. 149: Rear lamp assembly (rear)

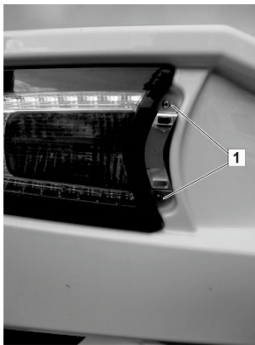

Fig. 150: Reattaching the rear lamp assembly

- 9.** Remove the bulb socket (2). Turn the bayonet mechanism to the zero position and pull off the socket.
- 10.** Replace the bulb.
- 11.** Insert the bulb socket (2) in the rear lamp assembly. Position the bayonet mechanism in the zero position, push and as far as it will go.
- 12.** Carefully insert the rear lamp assembly.
- 13.** Use a screwdriver to tighten the two screws (1) of the rear lamp assembly.

Malfunctions

9.2.3 Changing the smoke detector (optional) battery

The smoke detector is fitted with a 9 V block battery. To maintain the function of the smoke detector, the block battery must be replaced regularly, at the latest when the battery indicator signal sounds.

- Comply with the safety and operating instructions in the operating manual provided by the manufacturer!



Fig. 151: Removing the housing

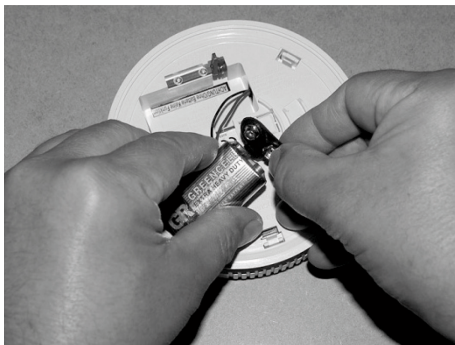

Fig. 152: Replacing the block battery

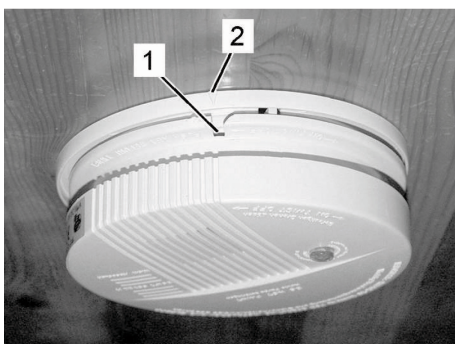

Fig. 153: Replacing the housing

1. Carefully rotate the housing of the smoke detector counter-clockwise (15° approximately) until it can be taken from the bracket.
2. Remove the spent block battery and disconnect it from the contact strip.
3. Connect the new block battery with the contact strip. The contact strip must engage on the poles of the block battery.
4. Insert the connected new battery in the battery compartment of the smoke detector.
5. place the smoke detector's housing with the notch (1) at the mark (2) and strongly press onto the bracket.
6. Carefully rotate the housing clockwise (15° approximately) until it latches in the bracket.

9.3 Gas supply

WARNING



Danger of injury due to escaping gas!

Escaping gas can explode.

- All repair work must be performed by an authorised gas specialist workshop.
- If gas odour is detected:
 - Immediately shut down the gas supply.
 - Do not operate any electric devices.
 - Remove fire and sources of ignitions.
- Do not smoke.

Malfunction	Cause	Remedy
Gas odour or higher gas consumption	Gas supply leaks	Have a specialist workshop inspect and repair the gas supply system
Gas device does not function	Quick-action valve closed	Open the quick-action valve
	Gas bottle valve closed	Open the gas bottle valve
	Outside temperature too low for camping gas	Only use propane if outdoor temperatures are low
	Gas device defective	Contact a specialist workshop

9.4 Hob

Malfunction	Cause	Remedy
No flame when igniting	Gas bottle valve or quick-action valve is closed	Open the gas bottle valve and quick-action valve
	Gas bottle empty	Replace gas bottle
Flame extinguishes immediately after the regulator is released	Warm-up period too short	Keep the rotary knob depressed for approximately 10 seconds after ignition.
	Safety pilot is defective	Contact a specialist workshop
Flame extinguishes when it is reduced	Safety pilot sensor is defective	Contact a specialist workshop

Malfunctions

9.5 Heater and hot water

9.5.1 Malfunctions, TRUMA heater

Fault	Cause	Remedy
Heating will not switch on	Window open	Close the window
Extremely long heating time	The water tank is clogged with limescale	Descale the water system
Water drains away - water tank cannot be filled	Safety/drain valve is open	Close safety/drain valve
The water tank cannot be drained, even though the safety/drain valve is open	The drainage outlet of the safety/drain valve is closed	Check the opening for dirt (slush, ice, leaves, etc.) and remove if necessary
	Water pipe frozen	Thaw the water pipe
Water is dripping/flowing out of the drainage outlet of the safety/drain valve	Water pressure too high	Check pump pressure (max. 2.8 bar)
		When connected to a central water supply (rural or city connection), a pressure reducer must be used to prevent pressures greater than 2.8 bar in the water tank
After switching off of the heating, the FrostControl opens	At temperatures less than about 3 °C, the FrostControl opens automatically	Switch on the heating. Without heating, the FrostControl can only be closed again at temperatures greater than about 7 °C
		Use a heating element for FrostControl
FrostControl can no longer be closed	Temperature at FrostControl less than about 7 °C	Switch on the heating. Without heating, the FrostControl can only be closed again at temperatures greater than about 7 °C
	Rotary switch is not set to "Operate"	Turn the rotary switch of the FrostControl to "Operate", then press the pushbutton until it engages
	FrostControl defective	Replace the FrostControl unit

Fault	Cause	Remedy
Heavy smoke formation from the wall stack for more than 1 minute after the unit has started up	Fuel supply failure, improper installation, limited combustion air supply	Danger of fire! Do not continue operating the unit
		Contact TRUMA Customer Service

9.6 Refrigerator

Refrigerator for 12 V operation (option)

Fault	Cause	Remedy
The refrigerator does not cool, the compressor does not start	The battery voltage is too low	Recharge the battery
	One minute start delay (no error)	Wait one minute
	Overheating due to high ambient temperature	Leave the refrigerator switched off for one hour, ventilate the vehicle, switchover to day mode operation
	Vehicle fuse is blown	Check the fuse rating, replace with 15 A fuse
Freezer compartment does not freeze	The interior temperature inside the vehicle is less than 16 °C	Increase the temperature inside the vehicle and/or select at least refrigeration level 4
The refrigerator does not cool, the compressor starts up, however it switches off immediately	Overheating due to high ambient temperature	Leave the refrigerator switched off for one hour, ventilate the vehicle, switchover to day mode operation
The refrigerator over cools items	The temperature setting is too high	Select a lower temperature setting
The refrigerator does not cool, the compressor runs continuously	Visit a service centre	

Malfunctions

Fault	Cause	Remedy
The refrigerator has too little refrigerating capacity	Overheating due to high ambient temperature	Leave the refrigerator switched off for one hour, ventilate the vehicle, switchover to day mode operation
	The ventilation openings are completely or partially blocked	Clean or rectify the blockage
	The door is incorrectly closed	Close the door, check whether the door seal is in good condition
	Too much ice on the evaporator [more than 3 mm]	Defrost the evaporator, check that the door seal is in good condition

9.7 Fresh water and waste water system

Malfunction	Cause	Remedy
Water leaks in the vehicle	Fresh water system or waste water system leaks	Identify leak points, repair the leaks
No fresh water	Freshwater tank empty	Fill the fresh water tank
	Water pump fuse is defective	Determine the defect and eliminate it; if necessary, consult a specialist workshop. Subsequently, replace the fuse in the Elektroblock.
	Water pump filter clogged	Clean or replace filter
	Water pump is defective	Replace the water pump
	Elektroblock defective	Contact a specialist workshop
Freshwater is cloudy	Tank has been filled with contaminated water	Clean the water system mechanically and chemically; disinfect the water system and flush thoroughly with drinking water
	Residues in the tank or fresh water system	

Malfunction	Cause	Remedy
The taste and odour of the fresh water has changed	Tank has been filled with contaminated water	Clean the water system mechanically and chemically; disinfect the water system and flush thoroughly with drinking water
	Fuel was inadvertently added to the freshwater tank	Contact a specialist workshop
	Microbiological deposits in the fresh water system	Clean the water system mechanically and chemically; disinfect the water system and flush thoroughly with drinking water
Deposits inside the tank and/or water-carrying components	The time to distribute water in the tank and/or water-carrying components is too long	Clean the water system mechanically and chemically; disinfect the water system and flush thoroughly with drinking water
There is no flushing water in the toilet	Freshwater tank empty	Fill the fresh water tank
	Water flushing fuse is defective	Determine the defect and eliminate it; if necessary, consult a specialist workshop. Then replace the fuse.
Wrong display of the filling level in the fresh water and waste water tank	Filling level sensor in freshwater and waste water tank dirty	Clean the filling level sensor of the fresh water or waste water tank
	Filling level sensor is defective	If necessary, have a specialised workshop replace the filling level sensor
Water does not drain in the shower, washbasin or kitchen sink	The waste water tank is full	Empty the waste water tank
	Siphon plugged	Clean siphon
The waste water tank cannot be emptied	The drain valve is clogged	Open the cleaning lid on the waste water tank, pull out the plug at the bottom of the tank and thoroughly clean the tank and the drain valve

Tightness guarantee

10 Tightness guarantee

10.1 Guarantee certificate

The guarantee certificate for your vehicle was given to you by your authorised distributor when the vehicle was transferred to you. This guarantee is only valid if it has been signed by the buyer and the authorised distributor.

- Keep the guarantee certificate in a safe place!

10.2 Guarantee conditions and terms

1. LMC GmbH & Co. KG, Rudolf-Diesel-Str. 4, 48336 Sassenberg (Warrantor) provides a water ingress warranty of 6 years for vehicles manufactured without Long Life Technology and 12 years for vehicles with Long Life Technology (LLT) as of the 2013 model year - but only up to a maximum total mileage of 120,000 km - guaranteeing that the following finally listed components of the caravan/motorhome or camper van have been sealed in such a way that no moisture can get inside (interior) of the vehicle when subject to normal contractual use.

Outer connection seams

- Roof/side wall
- Roof/rear wall
- Roof/driver's cab
- Walls/under body
- Chassis/under body

Outer sealing welds between mounted parts and the cut-outs of the body:

- Doors
- Window
- Service and garage hatches
- Roof hatches
- Water filling devices
- Electrical supply hatches

The warranty holder is responsible for proving that there is a warranty claim for the vehicle.

2. If a warranty claim based on a faulty seal is proven (see Section 1.), the warrantor is only obligated within the scope of these warranty provisions to remedy the affected vehicle parts by repairing or replacing the parts free of charge, depending on what the warrantor determines to be necessary for eliminating the water ingress. The necessary work will be carried out by the warrantor or by an authorized repair shop in accordance with the warrantor's guidelines. If additional costs are incurred when remedying the water ingress due to installations or other changes to the vehicle compared to the original state, these shall be borne by the warranty holder. The costs of warranty work, which was not carried out by the

warrantor or a repair shop authorized by the warrantor, are not eligible for reimbursement regardless of the existence of a warranty claim. This warranty does not entitle the warranty holder to any further claims against the warrantor, in particular to replacement delivery, withdrawal from the purchase agreement, a price reduction or compensation for damages (even in case of consequential damages) as well as to compensation for direct or indirect material or immaterial consequential damages. The warranty also does not include, e.g. claims for reimbursement of transport or travel costs, towing costs, lost wages or vacation time as well as reimbursement of any frustrated expenses. The legal rights of the warranty holder vis-a-vis the dealership is in no way affected by this warranty. The legal warranty rights of the warranty holder vis-a-vis the dealership exist independently of the claims from this warranty.

3. The warranty period begins, depending on which event occurs earlier, on the day of the vehicle's initial registration or the day the vehicle is handed over to the first buyer, but no later than 18 months after the vehicle was first delivered to the dealer. It is valid for the duration of the vehicle's usability, but no longer than 12 years, depending on which event occurs earlier and only up to a maximum total mileage of 120,000 km. The warranty is not affected by a change in ownership of the vehicle. The warranty expires if the annual inspections required under Section 4 are not carried out. The warranty period is not extended or restarted by the performance of warranty work.
4. A prerequisite for successfully asserting a warranty claim is to ensure that the vehicle is presented to an authorized LMC repair shop every year for the performance of a water ingress detection inspection. This inspection must be carried out annually after the start of the warranty period (see Section 3.). The costs for carrying out the water ingress detection inspection are to be borne by the warranty holder. The warranty holder can only assert claims under this warranty if he or she can prove that the annual inspections have been duly carried out by an authorized LMC repair shop. This includes an inspection record completed by the LMC dealership. The warranty holder is required to provide proof that the water ingress detection inspections have been performed regularly.
5. The warranty holder is required to report in writing the occurrence of a leak or any moisture indicating a leak to an authorized LMC repair shop within 15 days of becoming aware thereof. Negligent and gross negligent ignorance is equivalent to knowledge of water ingress. The receipt of the written notification by an authorized LMC repair shop is decisive for complying with the 15-day period. The warranty certificate must be included with the notification. No claim can be asserted under this warranty if the water ingress is not reported in a timely and proper manner.

Tightness guarantee

6. The necessity as well as the type and scope of the work to eliminate the leak or water ingress is solely at the discretion of the warrantor or its authorized repair shops.
7. The warranty does not cover:
 - Forces of nature (e.g. floods, hail, etc.) and animal damage of any kind
 - Damage resulting from an accident
 - Water ingress due to modifications or additions to the vehicle that have not been carried out by an authorized LMC repair shop.
 - Water ingress due to improperly repaired damage, which was not carried out by an authorized LMC repair shop.
 - Damage to the outer shell identified during inspections, which was not immediately taken care of by the warranty holder.
 - Aluminium corrosion that cannot be attributed to a leak or water ingress.
 - When the vehicle has been modified through use of replacement parts that have not been authorized by LMC and this has resulted in a warranty claim.
 - Condensation due to lack of ventilation
 - Improper, non-contractual handling and use of the vehicle
 - Damage caused by incorrect use of care products or cleaning agents (also see information provided under Vehicle care in the instruction manual)
 - Damage caused by non-compliance with the manufacturer's instruction manual as well as the repair and maintenance instructions
 - All other damage which cannot be attributed to the warrantor or its authorized repair shop.
8. Water ingress detection inspections are subject to costs. The costs of the inspections are to be borne by the warranty holder (see Section 4.).
9. Sole competent court is, as far as permissible by law, Sassenberg, Germany. The place of performance for all claims arising from this warranty is Sassenberg, Germany. This warranty is subject exclusively to the laws of the Federal Republic of Germany. This applies regardless of the warranty holder's place of residence or business.

10.3 Inspection schedule and inspection certificates

Verification

NOTE



The annual tightness tests are prerequisite for the tightness guarantee for the caravan body.

Verification of inspection must be completed by your authorised dealer after every executed test; it must be entered in the On-line system and printed for you.

10.3.1 Overview of the extent of the leak inspections

Visual inspections - interior	✓
Entry section	
Front bulkhead including connections on the floor plate and side walls	
Front bulkhead including connections on the floor plate and side walls	
Left side wall including connections on the floor plate and side walls	
Right side wall including connections on the floor plate and side walls	
Wheel housings left and right	
Roof cut-outs	
Connections to the driver's cabin	
Visual inspections of the motorhome's outside	✓
Exterior sheet metal	
Edge seals	
Connections to the driver's cabin	
Under-body	
Damages to the exterior shell	

Tightness guarantee

Measurements

Measured values up to 20 % are considered normal. For measured values greater than 20 %, check whether condensation has accumulated.

Measurement	Measured value
Floor measurements on the connecting points of the front/rear/side	
Measurements in the interior/walls, window apertures, roof hatch, cable conduit for the third brake light, etc.	

Spray with special sealant

Sealed points/edges	✓
Wheel housing	
Cut-out edges in the floor plates	
Butt joints	
Installation openings in the under-body	

11 Appendix

Legal notes on weight-related information

The weight specifications and tests for motor homes are uniformly regulated throughout the EU in EU Implementing Regulation No. 2021/535 (until June 2022: EU Implementing Regulation No. 1230/2012). We have summarised and explained the key terms and legal requirements from this regulation for you below. Our dealers and the LMC configurator on our website offer you additional assistance in configuring your vehicle.

1. Technically permissible mass

The technically permissible mass of the vehicle (e.g. 3,500 kg) is a mass specification set by the manufacturer which the vehicle must not exceed. Information on the technically permissible mass of the model you have chosen can be found in the technical data. If the vehicle exceeds the technically permissible mass in everyday driving, this constitutes an administrative offence which may result in a fine.

2. Mass in running order

In simple terms, the mass in running order is the basic vehicle with standard equipment plus a legally fixed standard weight of 75 kg for the driver. This essentially includes the following items:

- the unladen weight of the vehicle together with the bodywork, including operating fluids such as greases, oils and coolants;
- the standard equipment, i.e. all equipment items that are included as standard in the factory-fitted scope of delivery;
- the fresh water tank filled to 100 % in driving mode and an aluminium gas cylinder filled to 100 % with a weight of 16 kg;
- the fuel tank, which is 90 % full, including fuel;
- the driver, whose weight – regardless of the actual weight – is generally specified as 75 kg in accordance with EU law.

Information on the mass in running order can be found for each model in our sales documents. It is important to note that the value for mass in running order given in the sales documents is a default value determined in the type-approval procedure and verified by the authorities. It is legally permissible and possible for the mass in running order of the vehicle delivered to you to deviate from the nominal value stated in the sales documents. The legally permissible tolerance is $\pm 5\%$. In this way, the EU legislator accounts for the fact that certain fluctuations in the mass in running order occur due to variations in the weight of supplied parts as well as due to processes and weather conditions.

These weight deviations can be illustrated by means of an example calculation:

- Mass in running order acc. to sales documents: 2,850 kg
- Legally permissible tolerance of $\pm 5\%$: 142.50 kg
- Legally permissible range of mass in running order: 2,707.50 kg to 2,992.50 kg

Appendix

The specific range of permissible weight deviations can be found for each model in the technical data. LMC makes great efforts to reduce weight variations to the minimum that is unavoidable for production reasons. Deviations at the upper and lower end of the range are therefore very rare; however, they cannot be completely ruled out technically, even with all optimisations. The real weight of the vehicle and compliance with the permissible tolerance is therefore checked by LMC by weighing each vehicle at the end of the line.

3. Mass of the passengers

The mass of the passengers is set a standard value of 75 kg for each seat provided by the manufacturer, regardless of the actual weight of the passengers. The mass of the driver is already included in the mass in running order (see no. 2 above) and is therefore not included again. In the case of a motor home with four permitted seats, the mass of the passengers is therefore $3 * 75 \text{ kg} = 225 \text{ kg}$.

4. Optional equipment and actual mass

Optional equipment (also: additional equipment) includes, according to the legal definition, all optional equipment parts not included in the standard equipment which are fitted to the vehicle under the responsibility of the manufacturer – i.e. ex works – and can be ordered by the customer (e.g. awning, bicycle or motorbike carrier, satellite system, solar system, oven, etc.). Information on the individual or package weights of the optional equipment that can be ordered can be found in our sales documents. Optional equipment in this sense does not include other accessories that are retrofitted by the dealer or you personally after the vehicle has been delivered ex works. The mass of the vehicle in running order (see no. 2 above) and the mass of the optional equipment fitted to a specific vehicle at the factory are together referred to as the actual mass. You will find the corresponding information for your vehicle after handover under item 13.2 of the Certificate of Conformity (CoC). Please note that this specification also represents a standardised value. Since the mass in running order – as an element of the actual mass – is subject to a legally permissible tolerance of $\pm 5 \%$ (see no. 2), the actual mass may also deviate accordingly from the stated nominal value.

5. Pay mass and minimum pas mass

The installation of optional equipment is also subject to technical and legal limits: Only so much optional equipment can be ordered and fitted at the factory that sufficient free weight remains for baggage and other accessories (“pay-mass”) without exceeding the technically permissible mass. The pay-mass is calculated by subtracting the mass in running order (nominal value according to sales documents, see no. 2 above), mass of the optional equipment and the mass of the passengers (see no. 3 above) from the technically permissible mass (see no. 1 above). The EU regulations stipulate a fixed minimum pay-mass for motor homes, which must remain as a minimum for baggage or other non-factory-fitted accessories. This minimum pay-mass is calculated as follows:

Minimum pay-mass in kg $\geq 10 * (n + L)$

Where: “n” is the maximum number of passengers plus the driver and “L” is the overall length of the vehicle in metres.

For a motor home with a length of 6 m and 4 approved seats, the minimum pay-mass is therefore e.g. $10 \text{ kg} * (4 + 6) = 100 \text{ kg}$.

To ensure that the minimum pay-mass is maintained, there is a maximum combination of optional equipment that can be ordered for each vehicle model. In the above example with a minimum pay-mass of 100 kg, the total mass of optional equipment for a vehicle with four permitted seats and a mass in running order of 2,850 kg should not exceed 325 kg:

Technically permissible mass	3,500 kg
Mass in running order	- 2.850 kg
Mass of the passengers	- 3 * 75 kg
minimum pay-mass	- 100 kg
Maximum permissible mass of optional equipment	= 325 kg

It is important to note that this calculation is based on the default value for mass in running order as defined in the type-approval procedure, without taking into account the permissible weight deviations for mass in running order (see no. 2 above). If the maximum permissible value for the optional equipment of (in the example) 325 kg is almost or completely exhausted, an upward weight deviation can therefore result in the minimum pay-mass of 100 kg being met mathematically using the default value for the mass in running order, although in fact there is no corresponding load capacity. Here, too, an example calculation for a vehicle with four seats, whose real weighed mass in running order is 2 % above the nominal value:

Technically permissible mass	3,500 kg
Real weighed mass in running order (+ 2 % compared to the stated value of 2,850 kg)	- 2907 kg
Mass of the passengers	- 3 * 75 kg
Optional equipment (maximum permissible value)	- 325 kg
Actual load capacity (< minimum pay-mass of 100 kg)	= 43 kg

In order to avoid such a situation, LMC further reduces the maximum permissible weight of the total optional equipment that can be ordered on a model-specific basis. The limitation of optional equipment is intended to ensure that the minimum pay-mass, i.e. the legally prescribed free mass for baggage and retrofitted accessories, is actually available for the vehicle load capacity of the vehicles delivered by LMC.

Since the weight of a specific vehicle can only be determined when it is weighed at the end of the line, in very rare cases a situation may arise in which the minimum pay-mass at the end of the line is not guaranteed, despite this limitation of optional equipment. In order to guarantee the minimum pay-mass even in these cases, LMC will check together with your trade partner and you before delivery of the vehicle whether, for example, the vehicle is loaded up, seats are reduced or optional equipment is removed.

Appendix

6. Effects of tolerances of the mass in running order on the pay-mass

Regardless of the minimum pay-mass, you should note that unavoidable production-related fluctuations in the mass in running order – both upwards and downwards – have a mirror-image effect on the remaining load capacity: If you order our example vehicle (see no. 3. above), for example, with optional equipment with a total weight of 150 kg, the calculated pay-mass based on the default value for the mass in running order is 275 kg. The load capacity actually available may deviate from this value due to tolerances and may be higher or lower. If the mass in running order of your vehicle is, for example, permissibly 2 % higher than stated in the sales documents, the load capacity is reduced from 275 kg to 218 kg:

Technically permissible mass	3,500 kg
Real weighed mass in running order (+ 2 % compared to the stated value of 2,850 kg)	- 2907 kg
Mass of the passengers	- 3 * 75 kg
Optional equipment ordered for the specific vehicle	- 150 kg
Actual load capacity	= 218 kg

As a precaution to ensure that the calculated pay-mass is actually given, you should therefore take the possible and permissible tolerances for the mass in running order into account when configuring your vehicle. We also recommend that you weigh the laden motor home on a non-automatic scale before each journey and, taking the individual weight of the passengers into account, determine whether the technically permissible mass and the technically permissible maximum mass on the axle are observed.

Interior and exterior material care

Exterior cleaner	Material	Properties	Suitable	Unsuitable
Cleaning the paint surface	Polyester paint	Water-resistant, hard, scratch-sensitive, UV-sensitive	Cleaner for exterior painted surfaces	Acetone, solvent, thinners, scouring agents
Cleaning of acrylic glass panes	Acrylic glass	Scratch-sensitive, soft	Acrylic glass cleaner	Acetone, solvent, thinners, scouring agents, window cleaner, alcoholic cleaners
Cleaning of GFRP formed parts (gelcoat)	Coloured polyester resin or epoxy resin	Water-resistant, soft, scratch-sensitive, UV-sensitive	Cleaners/polishes for GFRP	Acetone, solvent, thinners, scouring agents
Cleaning of the aluminium-framed doors and flaps	Anodised or painted aluminium	Scratch-sensitive, soft	Mild cleaner for exterior painted surfaces	Aggressive cleaners for outdoor use with pH values > 9
Cleaning of plastic parts	ABS with PMMA (acrylic)	Scratch-sensitive, soft	Mild cleaner for exterior plastics	Aggressive cleaners for outdoor use with pH values > 9 acetone, solvent, thinners, scouring agents, window cleaner, alcoholic cleaners
Care of rubber seals	EPDM	Scratch-sensitive, soft	Mild cleaner for exterior use	Aggressive cleaners for outdoor use with pH values > 9 acetone, solvent, thinners, scouring agents, window cleaner, alcoholic cleaners

Appendix

Interior cleaner	Material	Properties	Suitable	Unsuitable
Floor cover	PVC, vinyl	Soft, abrasion resistant	Mild cleaner for plastics	Aggressive cleaners for toilets or tiles with pH values > 9 acetone, solvent, thinners, scouring agents, window cleaner, alcoholic cleaners, floor wax
Cleaners for shower trays, splash guards	Polystyrene	Scratch-sensitive, soft	Mild cleaner for plastics	Aggressive cleaners for toilets or tiles with pH values > 9 acetone, solvent, thinners, scouring agents, window cleaner, alcoholic cleaners
Toilet	Polypropylene	Robust, scratch-resistant	Cleaners recommended by the toilet manufacturer, see operating manual	Aggressive cleaners for toilets or tiles with pH values > 9 acetone, solvent, thinners, scouring agents, window cleaner, alcoholic cleaners
Sink/cooker	Anodised steel sheet, stainless steel sheet	Strong, abrasion-resistant, scratch-sensitive, stainless	Dishwasher detergent, vinegar-based cleaner	Acetone, solvent, thinners, window cleaner, alcoholic cleaners
Kitchen worktops, tabletops	High density melamine-faced compressed boards (Resopal-HPL)	Robust, scratch-resistant, temperature-resistant, dirt-resistant	Dishwasher detergent, vinegar-based cleaner	Acetone, solvent, thinners, scouring agents

Interior cleaner	Material	Properties	Suitable	Unsuitable
Furniture	Coated plywood, possibly real wood	Soft, not abrasion-resistant, scratch-sensitive	Damp cloth with water or a mild detergent	Acetone, solvent, thinners, scouring agents, window cleaner, alcoholic cleaners
Upholstery fabrics	Velours, microfibres, woven fabrics	Sensitive, depending on the type of fabric	Damp cloth with water or a mild detergent, brush	Acetone, solvent, thinners, scouring agents, window cleaner, alcoholic cleaners

Index

12 Index

- 2**
230 V mains connection 43
- A**
Actual weighed mass of your vehicle 34
Air-conditioning 72
Airing 114
Appendix 181
- B**
Baking 146
Bathroom 78, 79, 141
Battery charge status 87
Bistro table with table extension 133
Blackout blind 71, 73, 116, 117
- C**
Camping 106
Canopy light 94
Caravan body 63, 160
Changing light bulbs 165
Changing wheels 159
Check list 52
Cleanliness 31
Combination blind 71, 116, 117
Combination drain valve 109
Control panel 90
Crocery 80
- D**
Door blind 116
Door lock 66
Drain pipe 111
Drain valves 105
Driver cab curtain 72
Driving 50
- E**
Electrical system 27, 85
Emptying the waste holding tank 142
Entering 55
Entrance door 63, 64
Environmental protection 10, 31
Equipment, technical 85
Equipping the camper 106
Exhaust gases 31
Explanation of symbols used 9
Extending the rear support 60
Exterior cleaning 153
- F**
Faults
 Operating and control panel 164
Filler neck for fresh water 104
Filling levels 103
Fire safety 16
Floor heating 103, 131
Flushing 78
Flushing the toilet 141
Fly screen 71, 73, 116, 117
Folding and unfolding the bed 138
Fold-out seat pan as bed extension 135
Forced ventilation 73
Fresh water 104
 drain 108
 withdrawal 108
Fresh water tank 78, 104, 108
 filling 106
Fuelling 54
Furnishings 76
Fuses 49
 fuse plug-ins 43
 Main fuse 230 V 43
 Motorhome fuses 45
- G**
Gas cooker 80
Gas pressure spring 77
Gas supply 25, 96, 98

-
- General 17
 - Grilling 147
 - Guarantee 176
 - H**
 - Hatch lock 64
 - Hatch locks 66
 - Headrests 55
 - Heater 99, 100, 118
 - Heating 118
 - Heating the floor 103
 - Hinged window 69
 - Locking 70
 - Holidays 55
 - Hot water boiler 66, 78
 - Hot-air nozzle 101
 - I**
 - Increase in load capacity and reduction in load capacity 37
 - Inspection 157
 - Inspection certificate 179
 - Inspection schedule 159, 179
 - Intended use 13
 - Interior cleaning 154
 - Interior lighting 93
 - Introduction 7
 - K**
 - Keys 12
 - Keys for the motorhome 63
 - Kitchen 80
 - upper cabinet 83
 - Kitchen area 143
 - L**
 - Lay-up 89
 - LED displays 75
 - LED switches 75
 - Legal notes on weight-related information 181
 - Light switch 74
 - Load capacity 34
 - Load distribution and load securing 39
 - Locking 55, 64
 - Low pressure regulator 98
 - LT 460 A 90
 - M**
 - Main switch 44
 - Maintenance 152, 157
 - Maintenance hatch 66
 - Maintenance schedule 158
 - Malfunction 160
 - Malfunctions
 - cooking hob 171
 - electrical system 161
 - fresh water and waste water 174
 - gas supply 171
 - heater, hot water 172
 - light bulbs 165
 - refrigerator 173
 - mass on the axle 36
 - N**
 - Nameplate 32
 - O**
 - Opening 55, 64
 - Operating panel 90
 - Operating unit
 - Heater 100, 118
 - Hot water heater 100, 118
 - Operational reliability 25
 - Overview 62
 - P**
 - Parking 58
 - Power circuits 48
 - Power connection 106
 - Power outlets 95
 - Preparing the caravan for periods of non-use 155
 - R**
 - Range hood 80
 - Rear external storage locker 66, 82
-

Index

-
- Rear garage and rear storage space 41
 - Rear lamp unit 168
 - Registration plate 11
 - Repairing the tyre 159
 - Responsibility of the vehicle owner 14
 - Retracting the rear support 61
 - Roof loads 51
 - S**
 - Safety 13
 - About the base vehicle 17
 - Before the trip 22
 - brakes 20
 - electrical 27
 - fire safety 16
 - Fuelling 23
 - Gas devices 26
 - gas supply 25
 - general requirements 15
 - On the road 23
 - sanitary system 29
 - Trailer 20
 - Vehicle equipment 21
 - Safety and warning signs 9
 - Sanitary system 29
 - Seating area 77
 - Seats 55
 - Setting up the lighting 139
 - Shower 79
 - Shower stall 78
 - Sink 80
 - Sitting 133
 - Sitting area 136
 - Skylight 73
 - Skylights 73
 - Sleeping 133
 - Sleeping area 77
 - Smoke detector 76, 170
 - Snow chains 19
 - Starting your journey 55
 - Storage compartment
 - mirror cabinet 84
 - wall cupboards 83
 - washbasin cabinet 84
 - Storage compartments 82
 - Underbed 77
 - Storage space
 - kitchen 83
 - String-operated baffle 102
 - Supply battery 86
 - T**
 - Technical data 32
 - Technical documentation 8
 - Technical equipment 85
 - Technically permissible mass 33
 - Technically permissible mass on the axle 36
 - Toilet 78
 - Toilet chemistry 31
 - Traffic safety 17
 - Trailer 20
 - Travelling and parking 57
 - TRUMA Combi-D heater 99, 118
 - TV bracket 84
 - Tyres 19
 - V**
 - Vehicle
 - Checking the 52
 - parking 24
 - setup 59
 - Vehicle documents 8
 - Vehicle registration 11
 - W**
 - Wall cupboards 83
 - Wall exhaust stack 102
 - Washbasin 78
 - Waste 31
 - Waste holding tank 66, 78
-

Waste water 31, 104

 drain 111

Waste water tank 78, 111

Water heater 131

Water heating 100, 118

Weight specifications, load distribution and load
 securing 33

Wheels 19

